

## Non-Programmable Thermostat with 3 Temperature Pre-Sets Home, Sleep and Away

### Installation Instructions and User Guide

#### Message to Homeowner

Congratulations on choosing the Emerson Blue Easy Set Thermostat. The Easy Set is designed to be the easiest thermostat you have ever used. This thermostat features Home, Sleep, and Away temperature pre-sets. Just press the button and go. Included with the easy set is the same temperature accuracy and reliability you expect from all the Emerson Blue thermostats.



**Just Press the Button and Go!**

#### Table of Contents

<b>Get to know your thermostat.....</b>	<b>2</b>
Thermostat buttons and switches .....	2
Display .....	2
Batteries .....	2
<b>Using your thermostat .....</b>	<b>3</b>
Home, Sleep and Away temperature pre-sets .....	3
Sleep Timer option .....	3
Change Filter reminder option .....	3
Cool Savings option .....	3
<b>Installation .....</b>	<b>4</b>
Remove the old thermostat .....	4
Install the new thermostat .....	4
Set switches .....	4
Check thermostat operation .....	4
Select configuration options .....	5
Configuration menu .....	5
<b>Troubleshooting Guide .....</b>	<b>6</b>
<b>Technical Data .....</b>	<b>7</b>
Wiring diagrams .....	7
Thermostat application guide .....	8
Specifications .....	8

This thermostat is intended for use with a low voltage NEC Class II system. Do not use this thermostat with a line voltage system. If in doubt about whether your wiring is millivolt, line, or low voltage, have it inspected by a qualified heating and air conditioning contractor or electrician.

Do not exceed the specification ratings.

All wiring must conform to local and national electrical codes and ordinances.

This control is a precision instrument, and should be handled carefully. Rough handling or distorting components could cause the control to malfunction.

# Get to know your thermostat

Before you begin using your thermostat, you should be familiar with its features and with the display and the location and operation of the thermostat buttons and switches.

## The Thermostat Buttons and Switches

- ① Raises temperature setting.
- ② Lowers temperature setting.
- ③ Easy Temperature pre-sets (**Home, Sleep, Away**).
- ④ SYSTEM switch (**COOL, OFF, HEAT, EMER**).
- ⑤ FAN switch (**ON, AUTO**).

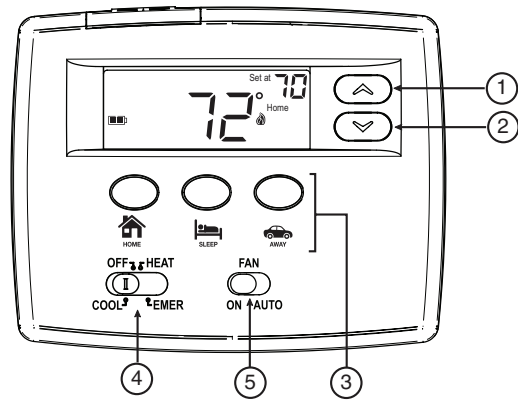

## The Display

- ⑥ Indicates desired temperature. This is blank when system switch is in the OFF position. Desired temperature is displayed (flashing) if the thermostat is in lockout mode.
- ⑦ “Save” indicates the Cool Savings feature is enabled in the configuration menu. “Save” flashing indicates Cool Savings feature is operating and saving energy. “Save” will also flash for 3 seconds after changing the temperature to indicate that a pre-set can be saved.
- ⑧ Indicates system mode. **Heat icon** (♁) is displayed when the SYSTEM switch is in the HEAT position. Heat icon (♁) is displayed flashing when thermostat is calling for heat. Cool icon (♁) is displayed when the SYSTEM switch is in the COOL position. Cool icon (♁) is displayed (flashing) if the thermostat is calling for cool.
- ⑨ Displays current temperature.
- ⑩ “Home”, “Sleep”, “Away” indicates the easy temperature pre-set is enabled.

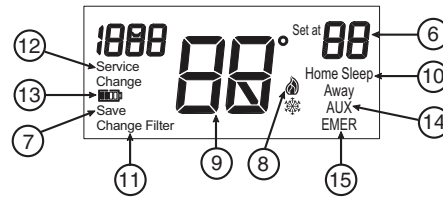

- ⑪ “Change Filter” is displayed when the system has run for the programmed filter time period as a reminder to change or clean your air filter.
- ⑫ “Service” indicates a diagnostic fault in the heating/cooling system. It does not indicate a fault in the thermostat.
- ⑬ “Change Filter” indicates power level of batteries. “Change Filter” indicates batteries should be replaced.
- ⑭ “AUX” indicates auxiliary stage is operating.
- ⑮ “EMER” is displayed flashing when the system switch is in EMER position.

## Batteries

Two “AA” alkaline batteries are included with your thermostat. Prior to use, open the battery door and remove the battery tag. We recommend replacing batteries every 2 years, for best results, use new premium brand alkaline batteries such as Duracell® or Energizer®. When battery power remaining is approximately half, the  will be displayed.

**Change**  Indicates batteries are low and should be replaced

### BATTERY LOCATION

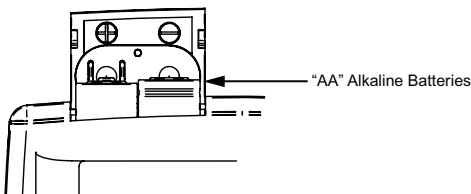

## CAUTION

If the home is going to be unoccupied for an extended period (over 3 months) and  is displayed, the batteries should be replaced before leaving. When less than two months of battery life remain, the setpoint temperature will change by 10 degrees (10 degrees cooler in Heat / 10 degrees warmer in Cool) to alert you to change the batteries before they fail. If the temperature change occurs, the normal setpoint can be manually reset. However, the temperature will change by 10 degrees within two days if the batteries are not replaced.

## WARNING

Do not use on circuits exceeding specified voltage. Higher voltage will damage control and could cause shock or fire hazard.  
Do not short out terminals on gas valve or primary control to test. Short or incorrect wiring will damage

thermostat and could cause personal injury and/or property damage.

Thermostat installation and all components of the system shall conform to Class II (current limited) circuits per the NEC code. Failure to do so could cause a fire hazard.



# Using your thermostat

## Home, Sleep and Away Temperature Pre-Sets



You can set your (Home, Sleep, Away) temperatures for use when you get home, go to sleep, or leave home. Then, just press the button you want and go.

Favorite Temperatures are set at the factory as indicated in the following table. You can use pre-sets or change to different temperature pre-sets.



Factory Pre-set Temperatures

	HEATING	COOLING
 HOME	70° F	75° F
 SLEEP	62° F	78° F
 AWAY	62° F	83° F



Your Pre-set Temperatures

	HEATING	COOLING
 HOME		
 SLEEP		
 AWAY		

## Change Home, Sleep and Away Temperature Pre-sets

1. Move SYSTEM switch to **HEAT** position.
2. Using the  or  button, set the desired temperature.
3. Press and hold the **Home, Sleep, or Away** button for 3 seconds. The display will go blank (except for the battery icon and heat/cool icon) and back on again indicating that the thermostat has saved your pre-set.
4. Repeat the process for the remaining Pre-sets to be changed.
5. Move SYSTEM switch to **COOL** to Pre-set Temperatures for cooling.

## Use Home, Sleep and Away Temperature Pre-Sets

1. Press the **Home, Sleep, or Away** button. The display will show the icon for the button pressed and display the temperature setting.
2. The thermostat will maintain the selected pre-set temperature until you change it by pressing the  or  button or selecting another Pre-set Temperature.



## Sleep Timer Option

The sleep timer will automatically change the thermostat from the Sleep to Home temperature after the number of hours set in the configuration menu. The Sleep timer default is 8 hours and can be changed to a setting between 1 to 12 hours.

Example: You have selected 8 hours for the Sleep timer in the configuration menu. Press the Sleep button, the thermostat will maintain the sleep temperature for 8 hours. After 8 hours the thermostat will go back to the Home temperature. The Sleep timer will be activated each time the sleep button is pressed.

## Change Filter Reminder Option

The thermostat can display a reminder when it is time to change the air filter on your heating and cooling system. The Change Filter will automatically display after the number of hours set in the configuration menu. The change filter reminder time default is 200 hours and can be changed to a setting of 25 to 1975 hours; 200 hours is approximately 3 months.

Example: You have selected 250 hours for the change filter reminder. The thermostat will display change filter after 250 it has counted down 250 hours. When **“Change Filter”** is displayed, press the  or  button to clear the display and restart the timer.

## Cool Savings™ Option

With Cool Savings enabled, the thermostat will make small adjustments to the desired temperature during periods of high demand to reduce cooling system running time and save energy. When the cooling system has been running for more than 20 minutes, humidity in the home will be lower and a higher temperature will feel comfortable. After 20 minutes of run time, the thermostat will start increasing the desired temperature in steps of less than one degree as the system continues to run. These adjustments will eventually cause the system to satisfy the thermostat and turn the system off to reduce the energy consumption. When the Cool Savings feature is active and making adjustments, the display will flash “Save”. The amount of adjustments to the desired temperature is dependent on the Cool Savings value that is set, 1 being the least adjustment and 6 being the most adjustment. With this feature set to OFF, no change will occur when the cooling system is continuously running during the periods of high demand. Periods of high demand will normally occur during the late afternoon and early evening on the hottest days of the summer.

# Installation

## Remove the Old Thermostat

1. Turn off power to the heating and cooling system.
2. Remove the front cover of the old thermostat, this usually pulls off.
3. Loosen the screws that hold the thermostat to the wall.
4. Identify each wire attached to the old thermostat.
5. Disconnect the wires from old thermostat one at a time. **DO NOT LET WIRES FALL BACK INTO THE WALL.**

## Install the New Thermostat

1. Open the battery door and detach the new thermostat cover from the base.
2. With the base flush against the wall, mark mounting hole locations on wall.
3. Move base out of the way and drill mounting holes.
4. Push wires through wire opening.
5. Position the base on the wall again and screw the mounting screws into the wall anchors.
6. Connect each wire coming from the wall to its corresponding terminal as shown in Fig. 2 on page 7.

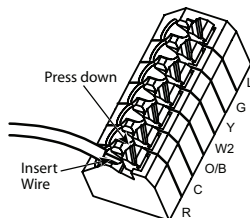

Wire Terminal Block

### NOTE

Wires will not be connected to all terminals of the terminal block.

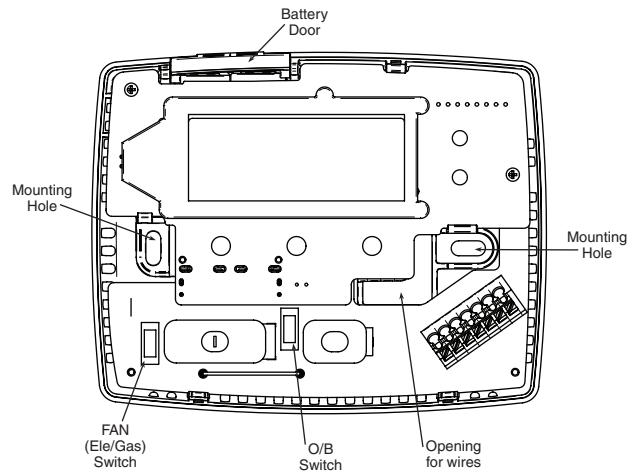

Figure 1. Thermostat Base

## Set Switches

### Fan (Ele/Gas) Switch



For Electric Heat, heat pump or any system that requires the thermostat to turn on the blower on a call for heat— place the FAN (Ele/Gas) switch (Fig. 1) in the **ON** position. For Auxiliary and Emergency Heat systems that have a fan control to turn on the blower (independent of the thermostat) place switch in the **OFF** position.

### O/B Terminal Switch Selection

The O/B switch on this thermostat is factory set to the “O” position. This will accommodate the majority of heat pump applications, which require the changeover relay to be energized in COOL. If the thermostat you are replacing or the heat pump being installed with this thermostat requires a “B” terminal, to energize the changeover relay in HEAT, the O/B switch must be moved to the “B” position.

## Check Thermostat Operation

### Heating System



1. Move SYSTEM switch to **HEAT** position. If the heating system has a standing pilot, be sure to light it.
2. Press  to adjust thermostat setting to 1° above room temperature. The heating system should begin to operate.
3. Press  to adjust temperature setting below room temperature. The heating system should stop operating.

### Fan Operation

If your system **does not** have a **G** terminal connection, skip to **Heating System**.



1. Move SYSTEM switch to OFF position.
2. Move fan switch to **ON** position. The blower should begin to operate.
3. Move fan switch to **AUTO** position. The blower should stop immediately.

### Cooling System

1. Move SYSTEM switch to **COOL** position.
2. Press  to adjust thermostat setting below room temperature. The blower should come on immediately on high speed, followed by cold air circulation. However, if the setpoint temperature is flashing, the compressor lockout feature is operating (see Configuration menu, item 5).
3. Press  to adjust temperature setting above room temperature. The cooling system should stop operating.

### Emergency System

EMER bypasses the Heat Pump to use the heat source wired to terminal **W2** on the thermostat. EMER is typically used when compressor operation is not desired, or you prefer back-up heat only.

1. Move SYSTEM switch to EMER position, EMER will flash on the display.
2. Press  to adjust the thermostat above room temperature. The Aux heating system will begin to operate. The **Flame icon** (⚡) will display flashing to indicate that the Aux system is operating.
3. Press  to adjust the thermostat below room temperature. The AUX heating system should stop operating.

## Select Configuration Options

The configuration menu allows you to set certain thermostat operating characteristics to your system or personal requirements.

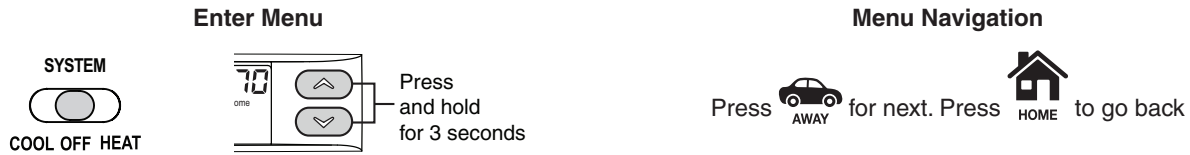

## Configuration Menu

Menu Screen Number	Displayed (Factory Default)	Press  or  to select options	
01	Sleep (OFF)	On	Select Sleep Timer On or OFF If selected OFF, skip to menu screen 04
02	h (8)	1 to 12	Select 1 to 12 hours for Sleep Timer On. See Sleep Timer section on page 3
03	CS (OFF)	On	Select Cool Savings Feature On or OFF If selected OFF, skip to menu screen 06
04	CS (3)	1 to 6	Select 1 to 6 for Cool Savings Feature On See Cool Savings section on page 3
05	CR (FA)	SL	Select Adjustable Anticipation, cycle rate for Heat Pump, Heat and Cool. See table below
06	CR Aux (FA)	FA	Select Adjustable Anticipation, cycle rate for Aux./Emer Heat. See table below
07	CL (OFF)	On	Select Compressor Lockout OFF or On. When selected On, the thermostat will wait 5 minutes before turning the compressor on.
08	L (On)	OFF	Select Display Light On or OFF. When selected On and the "C" terminal is connected, the backlight will stay on continuously. When OFF the backlight will come on for a short time when any key is pressed.
09	Room Temp (0)	4 LO to 4 HI	Select room temperature display for 4° higher or 4° lower than the actual temperature
10	°F	°C	Select °F or °C Display (temperature displayed in Fahrenheit or Celsius)
11	FH (On)	OFF	Select fast second stage On or OFF
12	Change Filter (OFF)	On	Select filter maintenance indicator OFF or On. If selected OFF, item B will be skipped
13	Change Filter (200 h)	25 to 1975	Select 25 to 1975 hours for Change Filter reminder See Change Filter reminder section on page 3



**To exit the menu:** Set the system switch to Cool or Heat. If no keys are pressed within fifteen minutes, the thermostat will revert to normal operation.

**Select Cycle Rate –** The cycle rate can be adjusted to keep the heat or cool on longer or shorter to match the temperature response of the home with your heating and cooling system.

MODE	Fast (FA)	Slow (SL)
Heat Pump	1.2°F	1.7°F
Aux./Emer Heat	.8°F	1.2°F

# Troubleshooting

## Reset Operation

If a voltage spike or static discharge blanks out the display or causes erratic thermostat operation, you may need to reset the thermostat. To reset, the System Switch must be in **Cool**, **HEAT**, or **EMER**. Simultaneously hold the  and  buttons

for approximately 10 seconds until the display goes blank. If the thermostat has power, has been reset and still does not function correctly contact your heating/cooling service person or place of purchase.

Symptom	Possible Cause	Corrective Action
<b>No Heat/No Cool/No Fan (common problems)</b>	<ol style="list-style-type: none"> <li>Blown fuse or tripped circuit breaker.</li> <li>Furnace power switch to OFF.</li> <li>Furnace blower compartment door or panel loose or not properly installed.</li> </ol>	Replace fuse or reset breaker. Turn switch to ON. Replace door panel in proper position to engage safety interlock or door switch.
<b>No Heat</b>	<ol style="list-style-type: none"> <li>System Switch not set to Heat.</li> <li>Loose connection to thermostat or system</li> <li>Heating System requires service or thermostat requires replacement.</li> </ol>	Set System Switch to Heat and raise setpoint above room temperature. Verify thermostat and system wires are securely attached.  Diagnostic: Set System Switch to Heat and raise the setpoint above room temperature. Within a five minutes the thermostat should make a soft click sound. This sound usually indicates the thermostat is operating properly. If the thermostat does not click, try the reset operation listed above. If the thermostat does not click after being reset contact your heating and cooling service person or place of purchase for a replacement. If the thermostat clicks, contact the furnace manufacturer or a service person to verify the heating system is operating correctly.
<b>No Cool</b>	<ol style="list-style-type: none"> <li>System Switch not set to Cool.</li> <li>Loose connection to thermostat or system.</li> <li>Cooling System requires service or thermostat requires replacement</li> </ol>	Set System Switch to Cool and lower setpoint below room temperature. Verify thermostat and system wires are securely attached. Same procedure as diagnostic for No Heat condition except set the thermostat to Cool and lower the setpoint below the room temperature. There may be up to a five minute delay before the thermostat clicks in Cooling if the compressor lock-out option is selected in the configuration menu.
<b>Heat, Cool or Fan Runs Constantly</b>	<ol style="list-style-type: none"> <li>Possible short in wiring.</li> <li>Possible short in thermostat.</li> <li>Possible short in Heat/Cool/Fan system.</li> <li>Fan Switch set to Fan On.</li> </ol>	Check each wire connection to verify they are not shorted or touching together. No bare wire should stick out from under terminal screws. Try resetting the thermostat as described below. If the condition persists, the manufacturer of your system or service person can instruct you on how to test the Heat/Cool system for correct operation. If the system operates correctly, replace the thermostat.
<b>Furnace Cycles Too Fast or Too Slow (narrow or wide temperature swing)</b>	<ol style="list-style-type: none"> <li>The location of the thermostat and/or the size of the Heating System may be influencing the cycle rate.</li> </ol>	The cycle rate adjustment can be found in the configuration menu. If an acceptable cycle rate is not achieved using the FA (Fast) or SL (Slow) adjustment contact a local service person for additional suggestions.
<b>Cooling Cycles Too Fast or Too Slow (narrow or wide temperature swing)</b>	<ol style="list-style-type: none"> <li>The location of the thermostat and/or the size of the Cooling System may be influencing the cycle rate.</li> </ol>	The cycle rate for cooling is fixed and can not be adjusted. Contact a local service person for suggestions.
<b>Thermostat Setting and Thermometer Disagree</b>	<ol style="list-style-type: none"> <li>Thermostat thermometer setting requires adjustment.</li> </ol>	The thermometer can be adjusted +/- 4 degrees as listed in the Configuration Menu. No other adjustment is possible.
<b>Blank Display and/or Keypad Not Responding</b>	<ol style="list-style-type: none"> <li>Voltage Spike or Static Discharge.</li> </ol>	If a voltage spike or static discharge occurs use the Reset Operation listed above.

Figure 2. Typical wiring diagram for single transformer systems

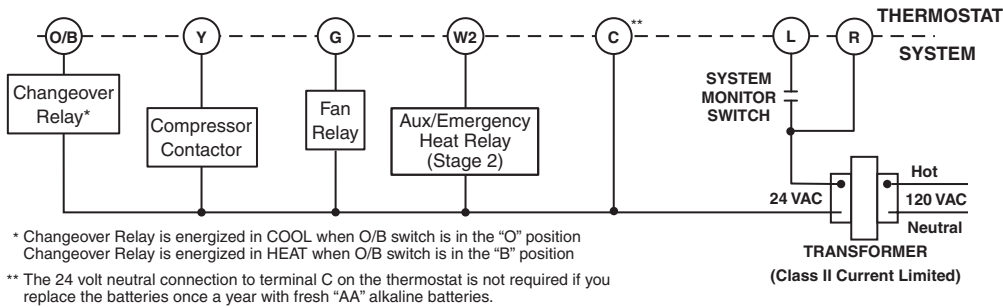

**THERMOSTAT APPLICATION GUIDE**

Thermostat Configuration Options	Thermostat Applications	Maximum Stages Heat/Cool
Heat Pump 1 Single Stage Compressor Heat Pump (HP)	Single Stage Compressor Heat Pump Systems - with Aux./Emergency Heat	2/1

**ATTENTION!**

This product does not contain mercury. However, this product may replace a unit which contains mercury.

Do not open mercury cells. If a cell becomes damaged, do not touch any spilled mercury. Wearing nonabsorbent gloves, take up the spilled mercury and place into a container which can be sealed. If a cell becomes damaged, the unit should be discarded.

Mercury must not be discarded in household trash. When the unit this product is replacing is to be discarded, place in a suitable container. Refer to [www.white-rodgers.com](http://www.white-rodgers.com) for location to send the product containing mercury.

**Specifications**

Electrical Rating:

Battery Power or Hardwire .....	20 to 30 VAC, 50/60 Hz or DC
Terminal Load .....	1.5 A per terminal, 2.5 A maximum all terminals combined
Setpoint Range .....	45° to 90°F (7° to 32°C)
Differential	Fast    Slow
Heat Pump .....	1.2°F    1.7°F
Aux./Emer Heat .....	.8°F    1.2°F
Operating Ambient .....	32° to +105°F (0° to +41°C)
Operating Humidity .....	90% non-condensing max.
Shipping Temperature Range .....	-40° to +150°F (-40° to +65°C)
Dimensions Thermostat .....	3-3/4" H x 4-3/4" W x 1-1/2" D

**Homeowner Help Line: 1-800-284-2925**

White-Rodgers is a division  
of Emerson Electric Co.

The Emerson logo is a  
trademark and service mark  
of Emerson Electric Co.

White  
Rodgers™

[www.white-rodgers.com](http://www.white-rodgers.com)  
[www.emersonclimate.com](http://www.emersonclimate.com)

  
**EMERSON™**  
Climate Technologies