

Supervisory Control Platform

FW 2.28

026-1803 R11



Installation and Operation Manual

COPELAND

Copeland
1065 Big Shanty Road NW, Suite 100
Kennesaw, GA 30144 USA
770-425-2724 • 1-800-829-2724

www.copeland.com

Email: ColdChain.TechnicalServices@copeland.com

FIRMWARE VERSION

2.28

For release notes and other product information, click [here](#).



WARNING! The enclosure should never be opened. Warranty void if seal is tampered with or removed.

FCC COMPLIANCE NOTICE

This device complies with Part 15 of the FCC Rules Class A. Operation is subject to the following two conditions: (1) this device may not cause harmful interference, and (2) this device must accept any interference received, including interference that may cause undesired operation.



CE COMPLIANCE NOTICE

Class A Product Information for Supervisory Controller:

The Supervisory Controller are Class A products. In a domestic environment this product may cause radio interference in which case the user may be required to take adequate measures.



ULE211299



ELECTROSTATIC DISCHARGE CAUTION

This integrated circuit can be damaged by ESD. Failure to observe proper handling and installation procedures can cause damage. ESD damage can range from subtle performance degradation to complete device failure. Precision integrated circuits may be more susceptible to damage because very small parametric changes may cause the device to not meet its published specifications.



CONTENTS

| | |
|--|------------|
| 1 INTRODUCTION..... | 1-1 |
| 1.1 SUPPORTED BROWSERS | 1-1 |
| 1.2 SECURITY | 1-1 |
| 1.3 DIRECT CONNECT INSTRUCTIONS - CONNECT YOUR LAPTOP TO SUPERVISORY CONTROLLER'S ETHERNET PORT ETH 1..... | 1-2 |
| 1.4 LOGGING INTO THE SUPERVISORY CONTROLLER | 1-3 |
| 1.5 HOW TO CHANGE THE IP ADDRESS | 1-4 |
| 1.5.1 Method 1: Direct Connect | 1-4 |
| 1.5.2 Method 2: USB Port..... | 1-4 |
| 1.6 SETUP WIZARD..... | 1-5 |
| 2 E3 HARDWARE OVERVIEW | 2-1 |
| 2.1 E3 ORDERING INFORMATION..... | 2-1 |
| 2.2 TECHNICAL SPECIFICATIONS | 2-2 |
| 2.3 PLUG-IN DIGITAL I/O CARD (P/N 537-4880) | 2-2 |
| 2.3.1 LED's..... | 2-2 |
| 2.4 WIRING..... | 2-3 |
| 2.5 ETHERNET CONNECTIONS | 2-3 |
| 2.6 E3 RS485 WIRING GUIDE EXAMPLE..... | 2-4 |
| 2.7 E3 WIRING DIAGRAMS | 2-7 |
| 3 SITE SUPERVISOR HARDWARE OVERVIEW | 3-1 |
| 3.1 ORDERING INFORMATION | 3-1 |
| 3.2 TECHNICAL SPECIFICATIONS | 3-2 |
| 3.3 SITE SUPERVISOR HOUSING DIMENSIONS AND MOUNTING..... | 3-3 |
| 3.4 WIRING DIAGRAMS..... | 3-4 |
| 3.5 DEVICE WIRING | 3-5 |
| 3.6 SITE SUPERVISOR POWER, SERIAL, AND IO POSITIONS..... | 3-5 |
| 3.6.1 Termination Jumpers..... | 3-5 |
| 3.6.2 Using a DC Volt Meter to Check Termination and Bias..... | 3-6 |
| 3.6.3 Removing The SD Card | 3-6 |
| 3.6.4 LEDs..... | 3-6 |
| 3.6.5 Dip Switch Termination and Biasing..... | 3-7 |
| 3.7 SERIAL CONNECTIONS | 3-8 |
| 3.8 WIRING TERMINAL DETAIL | 3-8 |
| 3.9 DIGITAL INPUTS | 3-9 |
| 3.10 RELAY OUTPUTS | 3-9 |
| 3.11 ANALOG INPUTS | 3-10 |
| 3.12 SITE SUPERVISOR WIRING EXAMPLES..... | 3-10 |
| 4 SUPERVISORY CONTROLLER BASIC NAVIGATION | 4-1 |
| 4.1 MENUS AND SUBMENUS..... | 4-1 |
| 4.2 COM PORT BANDWIDTH COLOR SCHEME | 4-2 |
| 4.3 COM PORT BANDWIDTH CALCULATOR..... | 4-3 |
| 4.4 OVERVIEW..... | 4-4 |
| 4.4.1 Conditional Visibility | 4-4 |
| 4.4.1.1 User View Details | 4-4 |
| 4.5 BASIC SCREEN ELEMENTS | 4-5 |
| 4.6 LANGUAGE SETTINGS | 4-6 |
| 4.7 LOCATING AND WORKING WITH APPLICATIONS | 4-7 |
| 4.8 APPLICATION TABS..... | 4-7 |
| 4.8.1 Performance Meter | 4-7 |
| 4.8.2 Site Aggregation..... | 4-7 |

- 4.8.3 Control Inventory..... 4-8
 - 4.8.3.1 Adding Applications 4-8
- 4.9 ADFs..... 4-9
- 4.10 CREATING A BACKUP AND RESTORE 4-9
 - 4.10.2 Encrypted Backup 4-10
 - 4.10.3 Restore..... 4-10
- 4.11 USING THE HELP MENU 4-11
- 4.12 ICONS OR BUTTONS APPEARING ON THE HOME SCREEN 4-12
- 5 LOGGING GROUPS..... 5-1**
- 5.1 SUPPORTED FUNCTIONS..... 5-1
- 5.2 DATA LOGGING TYPES..... 5-1
- 5.3 LOGGING GROUP FUNCTIONS 5-1
- 6 ALARM CONFIGURATION 6-1**
- 6.1 ALARM CONFIGURATION..... 6-2
- 6.2 ALARM COMMUNICATIONS..... 6-2
 - 6.2.1 Alarm Communications Setting..... 6-3
- 6.3 ALARM LOG AND VIEW HISTORY 6-4
- 6.4 TEMPERATURE DIFFERENTIAL ALARMS..... 6-4
- 6.5 LIGHTING CYCLE ALARMS 6-5
- 6.6 SMART ALARMING..... 6-6
 - 6.6.1 Accessing Smart Alarms..... 6-6
- 6.7 PEER ALARMING 6-7
- 6.8 GENERIC ALARMS..... 6-7
- 6.9 ALARM TYPES 6-7
- 7 RS485 I/O NETWORK BOARDS AND PERIPHERALS 7-1**
- 7.1 THE I/O NETWORK..... 7-1
- 7.2 I/O BOARD NAMES AND TERMINOLOGY..... 7-1
 - 7.2.1 MultiFlex Boards 7-1
 - 7.2.1.1 MultiFlex 16 Input Board..... 7-1
 - 7.2.1.2 MultiFlex Combination Input/Output Boards..... 7-2
 - 7.2.2 MultiFlex CUB Support 7-3
 - 7.2.3 MultiFlex RTU Support..... 7-3
 - 7.2.3.1 I/O Network and MultiFlex RTU Setup on Serial Port 7-3
 - 7.2.3.2 Creating an Instance of RTU Application..... 7-4
 - 7.2.3.3 Deleting/Checking Status of RTU Board..... 7-4
 - 7.2.3.4 Zone Management..... 7-4
 - 7.2.3.5 Scheduling 7-4
 - 7.2.3.6 Alarming 7-4
 - 7.2.3.7 Real Time Clock Updates..... 7-4
 - 7.2.3.8 Hand-Held Terminal Support 7-4
 - 7.2.4 MultiFlex RCB Support..... 7-5
 - 7.2.4.1 I/O Network and MultiFlex RCB Setup on Serial Port 7-5
 - 7.2.4.2 Creating an Instance of RCB Application..... 7-5
 - 7.2.4.3 Deleting/Checking Status of RCB Board..... 7-5
 - 7.2.4.4 Zone Management 7-5
 - 7.2.4.5 Scheduling 7-6
 - 7.2.4.6 Alarming 7-6
 - 7.2.4.7 Real Time Clock Updates..... 7-6
 - 7.2.4.8 Hand-Held Terminal Support 7-6
 - 7.2.5 MultiFlex RTU..... 7-6
 - 7.2.6 MultiFlex Rooftop Control Board (RCB) 7-6
 - 7.2.7 The MultiFlex ESR Board 7-7
 - 7.2.8 Hand-held Terminal (P/N 814-3110)..... 7-7
 - 7.2.9 The 8RO and 8ROSMT Relay Boards..... 7-8

| | | |
|----------|---|------------|
| 7.2.10 | 4AO Analog Output Board..... | 7-9 |
| 7.2.11 | 8DO Digital Output Board..... | 7-9 |
| 7.2.12 | XM Series of Case Controllers | 7-9 |
| 7.2.12.1 | XM670K v3.4 | 7-9 |
| 7.2.12.2 | XM679K v3.4 and v4.2..... | 7-10 |
| 7.2.12.3 | XM678D v2.5 and v2.8 | 7-10 |
| 7.2.13 | XEV22 v1.1 and v1.5 | 7-10 |
| 7.2.14 | Wireless I/O..... | 7-10 |
| 7.2.15 | Site Supervisor Displays..... | 7-11 |
| 7.2.16 | Programmable Touchscreen Thermostat..... | 7-12 |
| 7.2.17 | Control Techniques Drive (VSD) | 7-12 |
| 7.2.18 | DAC | 7-12 |
| 7.2.19 | Copeland Discus with CoreSense Diagnostics (ISD)..... | 7-13 |
| 7.2.20 | Copeland Discus with CoreSense Protection..... | 7-13 |
| 7.2.21 | Copeland Scroll - K5 Refrigeration Compressor | 7-13 |
| 8 | SITE SUPERVISOR DISPLAYS | 8-1 |
| 8.1 | 10.1-INCH TOUCHSCREEN DISPLAY..... | 8-1 |
| 8.1.1 | Display Connections..... | 8-1 |
| 8.1.2 | Specifications..... | 8-2 |
| 8.1.3 | Mounting Dimensions | 8-2 |
| 8.1.4 | Direct Connect to Site Supervisor | 8-3 |
| 8.2 | 15.6-INCH TOUCHSCREEN DISPLAY | 8-3 |
| 8.2.1 | Display Connections..... | 8-4 |
| 8.2.2 | Specifications | 8-4 |
| 8.2.3 | Mounting Dimensions | 8-4 |
| 8.2.4 | Direct Connect to Site Supervisor | 8-5 |
| 8.3 | 21.5-INCH TOUCHSCREEN DISPLAY | 8-6 |
| 8.3.1 | Display Connections..... | 8-6 |
| 8.3.2 | Specifications..... | 8-6 |
| 8.3.3 | Mounting Dimensions | 8-7 |
| 8.3.4 | Direct Connect to Site Supervisor | 8-7 |
| 8.4 | SITE SUPERVISOR TOUCHSCREEN DISPLAY VERSION COMPATIBILITY..... | 8-8 |
| 9 | SOFTWARE OVERVIEW | 9-1 |
| 9.1 | SUPERVISORY CONTROLLER APPLICATION AND SYSTEM CAPACITY MATRIX..... | 9-1 |
| 9.2 | SITE AGGREGATOR FEATURES..... | 9-6 |
| 9.3 | SYSTEM SUPERVISOR FEATURES..... | 9-7 |
| 9.4 | SUPERVISORY CONTROLLER MODEL SELECTION GUIDE | 9-8 |
| 9.5 | SUPERVISORY CONTROLLER TO E2 CROSS-REFERENCE GUIDE | 9-10 |
| 9.6 | SUPERVISORY CONTROLLER NEW FEATURES..... | 9-10 |
| 9.7 | SUCTION GROUPS..... | 9-11 |
| 9.7.1 | Introduction | 9-11 |
| 9.7.2 | The (Standard) Suction Group Application..... | 9-12 |
| 9.7.2.1 | Overview of PID Control Strategy..... | 9-12 |
| 9.7.2.2 | Variable-Speed Compressors..... | 9-12 |
| 9.7.2.3 | Floating Setpoint Control..... | 9-12 |
| 9.7.3 | The Enhanced Suction Group Application..... | 9-12 |
| 9.7.3.1 | Learning Mode..... | 9-12 |
| 9.7.3.2 | Circuit Load Analysis | 9-12 |
| 9.7.3.3 | The Control/Cycles Parameter | 9-13 |
| 9.7.3.4 | Variable-Speed, Digital Scroll, and Digital Discus Compressor Support | 9-13 |
| 9.7.3.5 | Floating Suction Control | 9-13 |
| 9.7.4 | Hardware Overview | 9-13 |
| 9.8 | SUCTION FLOAT..... | 9-14 |
| 9.9 | ANALOG SENSOR CONTROL..... | 9-14 |

9.9.1 Control Strategy..... 9-14

9.9.2 Control Alarming..... 9-15

9.9.3 Alarm Output When On/Off Parameters..... 9-15

9.9.4 Control Bypass 9-15

9.10 DIGITAL SENSOR CONTROL..... 9-15

9.10.1 Control Strategy 9-16

9.10.2 Command Alarming 9-16

9.10.3 Alarm Output When On/Off Parameters 9-16

9.10.4 Control Bypass..... 9-17

9.11 LIGHTING CONTROL 9-17

9.11.1 Lighting Control Logic 9-17

9.11.2 Light Level Sensor Verification..... 9-18

9.11.3 Solar Calculation 9-18

9.11.4 Digital Lighting Output 9-18

9.11.5 Light Proofing..... 9-18

9.11.6 Minimum On/Off Times 9-18

9.11.7 Dimming Control (Analog Output) 9-19

9.11.8 External Schedule 9-20

9.11.9 Lighting Bypass Inputs 9-20

9.11.10 Demand Shed Behavior..... 9-20

9.12 GLOBAL DATA..... 9-20

9.12.1 Location From..... 9-20

9.12.2 Sundown..... 9-20

9.13 HVAC CONTROL..... 9-20

9.13.1 Active Setpoint Determination 9-21

9.13.2 Setpoint Reset..... 9-21

9.13.3 Demand Shed..... 9-21

9.13.4 Heating and Cooling Control..... 9-22

9.13.5 Control Logic..... 9-22

9.13.6 Heat/Cool Lockout Based on Outside Air Temperature..... 9-22

9.13.7 System Shutdown..... 9-22

9.13.8 Fan Control..... 9-22

9.13.9 Fan Mode..... 9-22

9.13.10 Plenum Warmup/Purge..... 9-23

9.13.11 Fan Proof Failure..... 9-23

9.13.12 System Shutdown 9-23

9.13.13 Economization (Damper) Control..... 9-23

9.13.14 Determine the Analog Damper Position 9-24

9.13.15 Determine the Digital Damper Position..... 9-24

9.13.16 Heat Pump Control 9-24

9.13.17 Reversing Valve 9-24

9.13.18 Compressor Output 9-24

9.13.19 Curtailment..... 9-25

9.14 TIME SCHEDULE APPLICATION..... 9-25

9.14.1 Time Schedule Method..... 9-25

9.14.2 Standard Schedule..... 9-25

9.14.3 Event Names..... 9-25

9.14.4 Maintenance Schedule 9-26

9.14.5 Maintenance Overrides..... 9-26

9.14.6 Output Calculation 9-28

9.14.7 Scheduling Logic..... 9-28

9.14.8 Control Override..... 9-28

9.14.9 Control Bypass..... 9-29

9.14.10 Control Override 9-29

9.14.11 Special Conditions..... 9-29

| | | |
|----------|---|------|
| 9.14.12 | Priority of Services | 9-29 |
| 9.14.13 | Control Alarming | 9-29 |
| 9.14.14 | Schedule Category | 9-29 |
| 9.15 | DEMAND CONTROL | 9-30 |
| 9.15.1 | KWH Calculation | 9-30 |
| 9.15.2 | Demand Calculation | 9-30 |
| 9.15.3 | Shed Outputs | 9-30 |
| 9.15.4 | Application Alarms | 9-31 |
| 9.15.5 | KW Load Specification | 9-31 |
| 9.15.6 | Performance Requirements | 9-31 |
| 9.16 | UTILITY MONITORING | 9-31 |
| 9.16.1 | Utility Usage Calculation | 9-32 |
| 9.16.1.1 | Utility Type | 9-32 |
| 9.16.1.2 | Electrical Usage | 9-32 |
| 9.16.2 | Consumption Totalizing | 9-32 |
| 9.16.2.1 | Fixed Period Totalizers | 9-32 |
| 9.16.2.2 | User Totalizer Output | 9-32 |
| 9.16.2.3 | Utility Logging Group | 9-32 |
| 9.16.3 | Demand Shedding | 9-33 |
| 9.16.3.1 | Overview | 9-33 |
| 9.16.3.2 | Average Rate of Consumption | 9-33 |
| 9.16.3.3 | Shed Output | 9-33 |
| 9.16.3.4 | Demand Limit Exceeded Alarm | 9-33 |
| 9.16.3.5 | Time In Shed Output | 9-33 |
| 9.17 | ONBOARD I/O | 9-33 |
| 9.17.1 | Licensing | 9-33 |
| 9.17.2 | Adding and Deleting Onboard I/O Application | 9-33 |
| 9.17.3 | Status and Detail Screen | 9-35 |
| 9.17.4 | Alarming | 9-35 |
| 9.18 | XR75CX 5.6 | 9-35 |
| 9.19 | XR35CX 5.6 AND 2.6 | 9-36 |
| 9.19.1 | Overview | 9-37 |
| 9.19.2 | Command-Alarm Matrix | 9-37 |
| 9.20 | XC645CX 2.5 | 9-39 |
| 9.20.1 | Application Advisories | 9-40 |
| 9.20.2 | Command-Alarm Matrix | 9-40 |
| 9.21 | XR75CX CASE DISPLAY | 9-42 |
| 9.21.1 | Overview | 9-42 |
| 9.21.2 | Application Advisories | 9-42 |
| 9.21.3 | Inputs | 9-43 |
| 9.22 | XR75CX 2.6 | 9-43 |
| 9.22.1 | Application Advisories | 9-44 |
| 9.22.2 | Command | 9-44 |
| 9.23 | T-STAT | 9-45 |
| 9.23.1 | General Control | 9-45 |
| 9.23.2 | Alarms | 9-45 |
| 9.23.3 | Device Commissioning | 9-45 |
| 9.24 | TOUCH T-STAT | 9-45 |
| 9.25 | ENERGY METER | 9-46 |
| 9.26 | DATA LOGGING AND GRAPH | 9-46 |
| 9.27 | FLEXIBLE COMBINER | 9-46 |
| 9.28 | RLDS (REFRIGERANT LEAK DETECTOR SYSTEM) | 9-47 |
| 9.28.1 | Communication | 9-47 |
| 9.28.2 | Supported Gases | 9-47 |
| 9.29 | ECB VAV | 9-47 |
| 9.30 | MRLDS (MODULAR REFRIGERANT LEAK DETECTOR SENSORS) | 9-48 |

9.31 CONTROL LINK ANTI-CONDENSATE CONTROLLER (CL ACC) 9-48

 9.31.1 Alarm Handling Logic 9-48

 9.31.2 Alarms Configuration 9-48

9.32 HVAC ZONE..... 9-48

 9.32.1 How It Works..... 9-49

 9.32.2 Compatible Applications to be Connected to HVAC Zones..... 9-49

 9.32.3 Temperature Control..... 9-49

 9.32.4 HVAC Zone Temperature..... 9-49

 9.32.5 Economizer Control..... 9-49

 9.32.6 Economization Enable..... 9-50

 9.32.7 The Effect of Enabling Economization 9-50

 9.32.8 Dehumidification Control 9-50

 9.32.9 HVAC Zone Humidity Input..... 9-51

 9.32.10 Enabling Dehumidification Effect 9-51

 9.32.10.1 MultiFlex RTUs and RCBs..... 9-51

 9.32.11 Optimum Start/Stop (OSS)..... 9-51

 9.32.12 Intelligent Pre-Starts and Pre-Stops..... 9-51

 9.32.13 Setpoint Reset..... 9-52

9.33 AHU 9-52

9.34 ANALOG AND DIGITAL COMBINER..... 9-52

9.35 ANTI-SWEAT CONTROL 9-53

9.36 CONDENSER CONTROL..... 9-53

 9.36.1.1 Air Cooled Strategy 9-54

 9.36.1.2 Temperature Differential Strategy..... 9-54

 9.36.2 Evaporative Condensers..... 9-54

 9.36.3 Fan Control..... 9-54

 9.36.4 Condenser Split Mode 9-54

 9.36.5 Fast Recovery 9-54

 9.36.6 Hardware Overview 9-55

9.37 STANDARD CIRCUITS 9-55

9.38 CASE CONTROL CIRCUITS..... 9-56

 9.38.1 Overview..... 9-56

 9.38.2 Case Circuit Control Software Overview 9-56

 9.38.2.1 Valve Control..... 9-56

 9.38.3 Refrigeration Control..... 9-57

 9.38.3.1 EEVs (Liquid Pulse and Liquid Stepper) 9-57

 9.38.3.2 EEPRs (Suction Stepper)..... 9-57

 9.38.4 Defrost Control..... 9-58

 9.38.4.1 Defrost States 9-58

 9.38.4.2 Defrost Types 9-58

 9.38.4.3 Defrost Termination..... 9-58

 9.38.4.4 Demand Defrost 9-59

 9.38.4.5 Emergency Defrost..... 9-59

 9.38.4.6 Defrost Schedule Summaries..... 9-59

9.39 IRRIGATION CONTROL..... 9-59

9.40 TD CONTROL..... 9-60

 9.40.1 Overview..... 9-60

 9.40.2 Temperature Differential (TD) Strategy..... 9-60

 9.40.3 TD Control Fail-Safes..... 9-60

 9.40.4 Configuration..... 9-60

 9.40.5 Setpoints 9-61

 9.40.6 Inputs..... 9-61

 9.40.7 Alarms..... 9-61

9.41 LOOP/SEQUENCE CONTROL 9-61

9.42 MODULAR CHILLER CONTROL..... 9-62

 9.42.1 Learning Mode 9-62

| | | |
|--------------------|--|-------------|
| 9.42.2 | The Control/Cycles Parameter | 9-62 |
| 9.42.3 | Compressor Control..... | 9-63 |
| 9.42.3.1 | Digital Scroll Compressor | 9-63 |
| 9.42.3.2 | Variable Frequency Drive Compressor..... | 9-63 |
| 9.42.3.3 | Unequal Capacity Compressors..... | 9-63 |
| 9.42.4 | Bypass Valve Control..... | 9-63 |
| 9.43 | XM CIRCUIT CONTROL..... | 9-63 |
| 9.43.1 | Associations..... | 9-64 |
| 9.43.1.1 | Case Circuit Association Support | 9-64 |
| 9.43.1.2 | Dual Association Not Supported..... | 9-64 |
| 9.43.1.3 | Synchronized Parameters..... | 9-64 |
| 9.43.1.4 | Visibility of Associated Parameters..... | 9-64 |
| 9.43.2 | Suction Group Interaction..... | 9-64 |
| 9.43.2.1 | Standard Suction | 9-64 |
| 9.43.2.2 | Enhanced Suction | 9-65 |
| 9.43.3 | Supervisory Control Functions | 9-65 |
| 9.43.3.1 | Dewpoint Value | 9-65 |
| 9.43.3.2 | Lighting Control | 9-65 |
| 9.43.3.3 | Active Setpoint Output..... | 9-65 |
| 9.43.3.4 | Defrost Scheduling..... | 9-65 |
| 9.43.3.5 | Case States | 9-65 |
| 9.43.3.6 | Case Type | 9-66 |
| 9.43.4 | Application Advisory | 9-66 |
| 9.43.4.1 | Synchronized Alarm Parameters..... | 9-66 |
| 9.43.5 | Application Commands..... | 9-66 |
| 9.43.5.1 | Start Defrost..... | 9-66 |
| 9.43.5.2 | Stop Defrost..... | 9-66 |
| 9.43.5.3 | Case Clean Out | 9-66 |
| 9.43.6 | Product Probe Support | 9-66 |
| 9.44 | XR75CX CASE DISPLAY | 9-66 |
| 9.45 | BOILER..... | 9-66 |
| 9.46 | XJ CONDENSING UNIT..... | 9-67 |
| 9.47 | CAN Bus - IPX (EXPANSION MODULE) | 9-67 |
| 9.47.1 | IPX 6 Relay..... | 9-68 |
| 9.47.2 | IPX 15 Relay | 9-68 |
| 9.47.3 | IPX 25 Relay | 9-69 |
| 9.48 | SUPPORTED REFRIGERANTS | 9-69 |
| 10 | FLOOR PLANS | 10-1 |
| APPENDIX A: | ALARM ADVISORIES..... | A-1 |
| APPENDIX B: | TROUBLESHOOTING..... | B-1 |
| APPENDIX C: | SETTING UP EMAIL AND TEXT ALERTS IN YOUR SUPERVISORY CONTROLLER..... | C-1 |
| APPENDIX D: | UTILITY MONITORING | D-1 |
| APPENDIX E: | PEER TO PEER NETWORK SETUP FOR MIXED SITES (TWO SUPERVISORS AND ONE E2) | E-23 |
| APPENDIX F: | USING THE E2 SETPOINT CONVERSION TOOL WHEN RETROFITTING E2 WITH SUPERVISORY OR E3 CONTROLLERS: USING THE LATEST VERSION OF ULTRASITE32™ | F-1 |
| APPENDIX G: | FIRMWARE UPDATE..... | G-1 |
| APPENDIX H: | RESET AND CLEAN OUT SUPERVISORY CONTROLLERS..... | H-1 |
| APPENDIX I: | SUPERVISOR SCHEDULING AND EVENTS TRAINING | I-1 |

1 Introduction

Supervisory controllers are systems that combine energy management with the ability to monitor various facility systems and provide alerts when there are issues that need attention. This system provides HVAC control, Refrigeration System Monitoring and Control, as well as Lighting Control. In addition, the supervisory controller can monitor and report energy consumption and take action to reduce the energy demand during peak periods. This can have a direct impact on utility bills by reducing total energy costs. E3 ensures that the HVAC and lighting systems are on and off at the appropriate times. This ability to monitor store conditions can potentially minimize energy consumption.

Robust and flexible next generation facility management and refrigeration controller offers greatly enhanced functionalities like prioritized alarms, floor plan views and asset performance. With the same form and fit as the E2, the E3 is fully backward compatible with IONet and multiflex devices.

1.1 Supported Browsers

- Google Chrome 105.0.5195 and later
- Firefox 105.0 and later
- MAC Safari 14.1.2 and later
- iOS Safari 14.7 and later
- Microsoft Edge 84.0.522 and later
- Android Chrome/WebView 105.0.5195 and later

1.2 Security

At Copeland, we prioritize the security and safety of our customers and their systems. Over time, Copeland has conducted a variety of security assessments and penetration tests against this control system. Any critical issues that were discovered during these testing procedures are addressed in updates and releases of the product. As threats and vulnerabilities continue to evolve and be discovered we will continue to assess, test and update these control systems during their active life cycle to help provide peace of mind to our customers.

Copeland recommends adhering to all instructions and specifications included with the device and following all security industry best practices, including but not limited to:

- Never expose the control system to the broader internet
- Eliminate or restrict access to administrative and generalized protocols like SSH, FTP
- Restrict inbound/outbound communications to and from the device
- Ensure default accounts are updated, and strong passwords are used
- Configure and enable TLS for web-based traffic
- Apply patches and updates in a timely manner

1.3 Direct Connect Instructions - Connect your laptop to Supervisory Controller's Ethernet Port ETH 1

All configuration can be accomplished through the E3's built-in display or through a laptop, PC, or tablet. On your PC:

1. Under **Control Panel - Network and Sharing Center**, select **Change adapter settings**.
2. Select the **Local Area Connection** port being used.
3. Select **Properties**.
4. Highlight the section **Internet Protocol Version 4 (TCP/IPv4)** and click **Properties**:
5. Click **Use the following IP address**: and enter the IP address **192.168.1.251** and the Subnet mask **255.255.255.0** of the PC being used on the Local Area Network or direct connection and click **OK**:

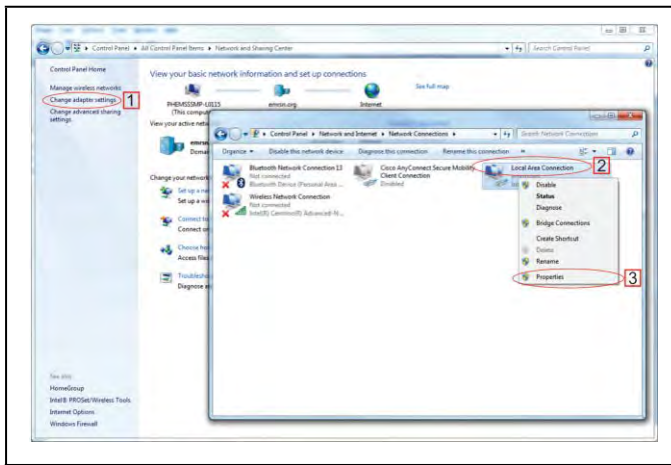

Figure 1-1 - Change Adapter Settings

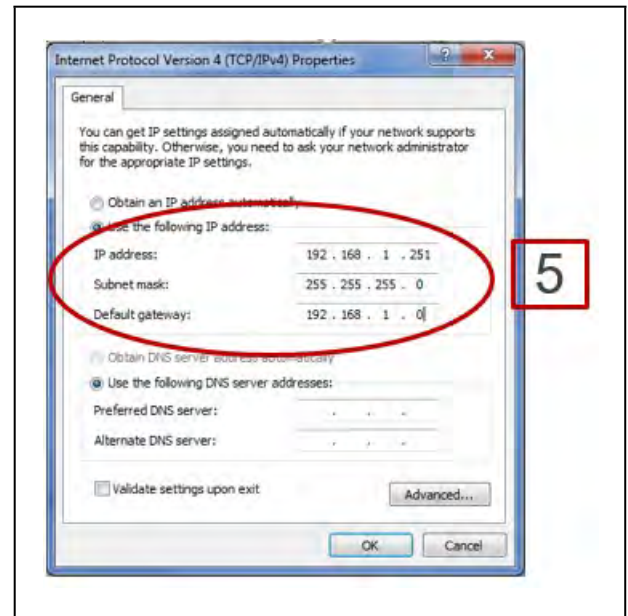

Figure 1-3 - IP Address and Subnet Mask

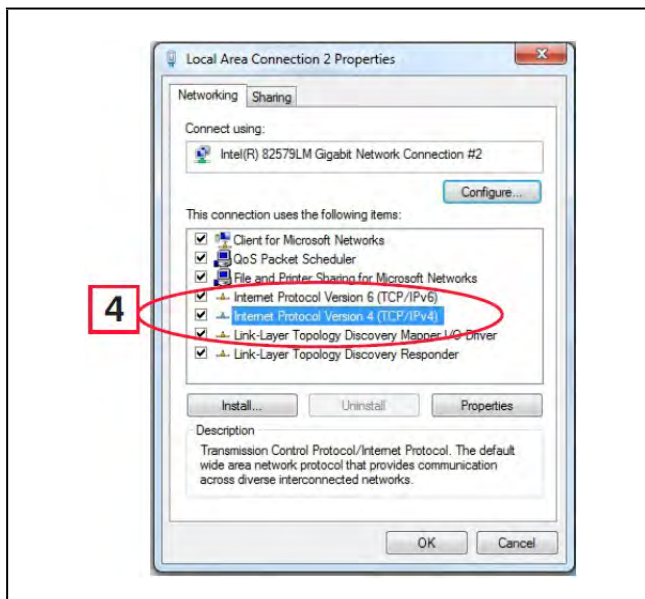

Figure 1-2 - Highlight Internet Protocol Version 4 (TCP/IPv4)

1.4 Logging Into the Supervisory Controller

1. Launch a preferred web browser: Google Chrome 105.0.5195 and later, Firefox 105.0 and later, MAC Safari 14.1.2 and later, iOS Safari 14.7 and later, Microsoft Edge 84.0.522 and later, and Android Chrome/WebView 105.0.5195 and later
2. Enter the IP Address of the Supervisor.
3. Enter your Username/Password (default user/pass) and click Login. Update the password to the minimum complexity requirements and click **Save**. **Note that after the first login using the default user/pass, the password must be updated.**

Note that when directly connecting your laptop or PC to ETH1, enter the default IP into the browser address bar: ETH1 Default IP Address is 192.168.1.250

Note: If an incorrect password is entered 10 times in a row, the user will be locked out for 20 minutes. A message will appear to show the number of remaining attempts.

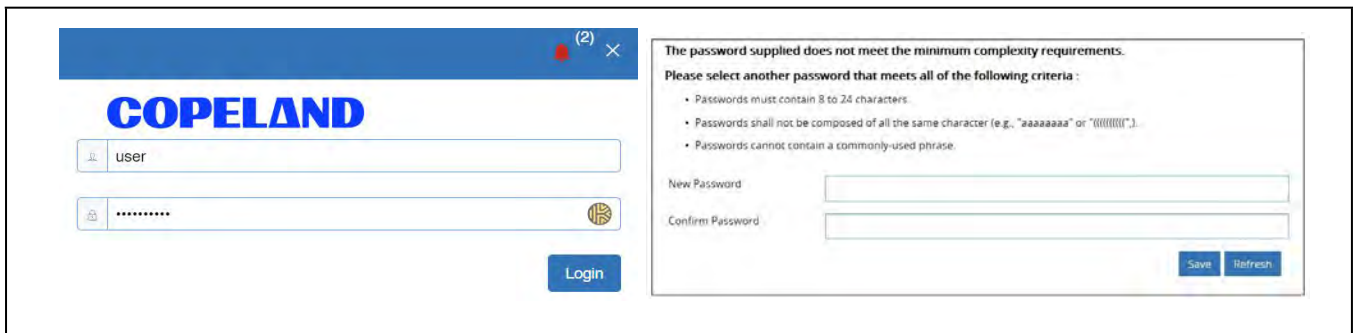

Figure 1-4 - Login Screen at Controller Startup and Update Password

Password Standards - Security Enhancement

To ensure the highest level of protection and security, it requires users to create passwords for logging into Supervisory controllers that meet certain criteria and National Institute of Standards and Technology (NIST) recommendations (nist.gov).

1. The password cannot contain the username.
 - Example: **Username:** JSmith; **Password:** JSmith123 - this password will be rejected
2. The password cannot contain the following context-specific words from the general system properties setup:
 - Site Name
 - Unit Name
 - Group Name
 - Host Name
 - Domain Name
3. Passwords must contain 8 to 24 characters.
4. Passwords cannot be composed of all the same characters (For example, "aaaaaaaa" or "88888888")
5. Passwords cannot contain a commonly-used phrase.

1.5 How to Change the IP Address

1.5.1 Method 1: Direct Connect

1. Select the Main Menu  icon > **Configure System** > **General System Settings** > **Network Settings**:

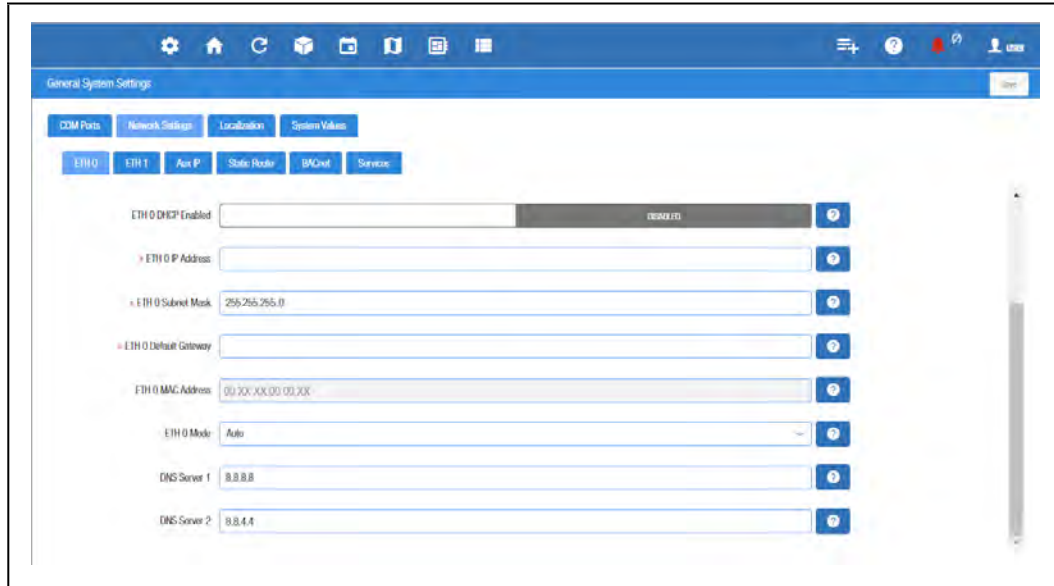

Figure 1-5 - Enter IP Address in the ETH 0 IP Address Field

2. On the *INTERNET (TCP/IP)* section on the screen, enter the IP Address in the **ETH 0 IP Address** field.

Note that you can set up the Peer Group, Unit Number, Network Mask, and Default Gateway on this screen.

1.5.2 Method 2: USB Port

1. Create a "network.txt" with your desired settings (**Figure 1-5**):

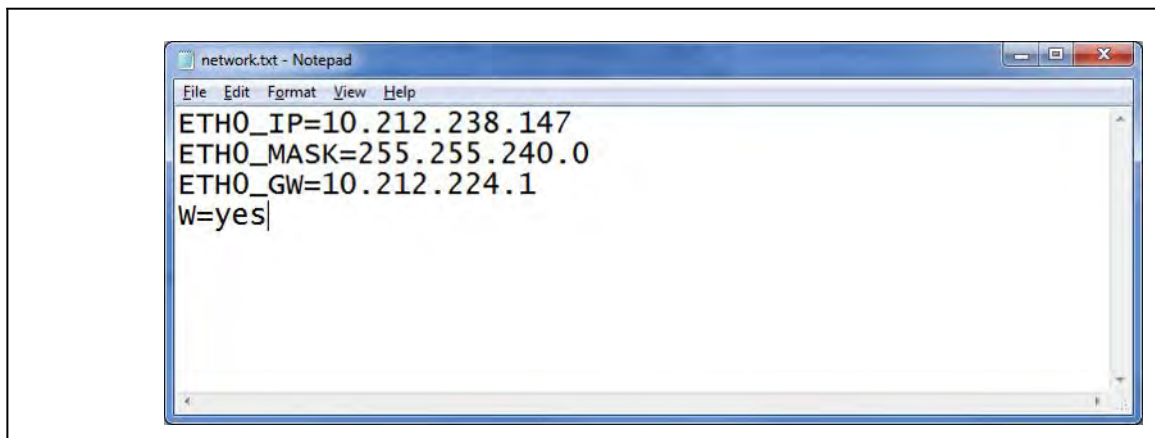

Figure 1-6 - Network.txt Notepad

2. Save to the root folder of a thumb drive. Insert the thumb drive into the USB port of E3.
3. Power cycle the E3. The new IP Address will be saved.

1.6 Setup Wizard

Note that if setpoints have been pre-loaded in the unit, the Setup Wizard will not auto-start after logging in.

If your unit has been received directly from the Copeland factory, the Setup Wizard will open and take you through the following setup screens:

Localization Screen

Figure 1-7 - Localization Screen

Set the E3's localization data such as language, date and time formats, and engineering units from the Localization screen.

Language: The default for the language selection is American English (United States). The system stores a setting for the preferred system language (internal language code). The default language is used when no user is currently logged into the E3 or when the currently active preferred language does not have a translation for a given label, prompt, or display text.

Date: The Date format can be set to either Day, Month, and full Year (D-M-YR) or Month-Day and full Year (M-D-YR) format. The day, month, and year values are separated by either a forward slash or a dash line depending on user selection.

The Date Format can be changed based on user preference and saved to user profiles. On initial E3 startup, the Date format defaults to the format of the language selected. For example, en-US will default to D-M-YR and all others will default to M-D-YR.

Time: The Time format can be set to either a 12-hour (12-hr) format or 24-hour (24-hr) format. The hour, minute, and second values are separated by either a colon or a period depending on user selection.

The Time format can be changed based on user preference and saved to user profiles. On initial E3 startup, the Time format defaults to the format of the language selected.

Date and Time delimiters default to forward slashes and colons.

Engineering Units: The default engineering units are based on the assigned units for the chosen preferred language. Users can choose or change their preferred set of engineering units and save them to their user profiles.

The default engineering units are based on the International System of Units (SI System) format.

Set the system language type in the Language drop-down menu. Click the right arrow > to save and proceed to the System Values screen.

System Values Screen

From the **System Values** screen, name the unit by entering it in the **Site Name** field. The Confirmation window will slide open. Click **OK**. Then click the right arrow > to proceed to the Network Settings Screen.

Figure 1-8 - System Values Screen

Network Settings Screen

Configure the settings on the Internet TCP/IP screen such as host name, text, and email settings. If you have Internet access, enter the **IP Subnet Mask** and **Default Gateway** settings (see your IT Administrator). If connecting directly to a laptop, use the Default IP and leave the DHCP set to **Disable**. For text messaging, enable the SMS setting and use the SMTP address (see your IT Administrator). Click the arrow > to save and finish the Setup Wizard.

Figure 1-9 - Network Settings Screen

2 E3 Hardware Overview

The E3 (P/N 860-1300) is a system that combines energy management with the ability to monitor various facility systems and provide alerts when there are issues that need attention. This system provides HVAC control, Refrigeration System Monitoring and Control, as well as Lighting Control. In addition, the E3 can monitor and report energy consumption and take action to reduce the energy demand during peak periods. This can have a direct impact on utility bills by reducing total energy costs. E3 ensures that the HVAC and lighting systems are on and off at the appropriate times. This ability to monitor store conditions can potentially minimize energy consumption.



Figure 2-1 - E3 Controller

2.1 E3 Ordering Information

| Part Number | E3 Facility Control |
|-------------|-------------------------|
| 860-1300 | E3, SF |
| 860-1305 | E3, RX |
| 860-1310 | E3, RXe |
| 860-1315 | E3, BX |
| 860-1320 | E3, BXe |
| 860-1325 | E3, CX |
| 860-1330 | E3, CXe |
| 860-1340 | E3, Site Aggregator |
| 860-1341 | E3, Service Replacement |

Table 2-2 - E3 Ordering Part Numbers

2.2 Technical Specifications

| | |
|--|---|
| Operating Temperature | -40°F to 113°F (-40°C to 45°C) * Tested to UL60730-1 standard |
| Operating Humidity Storage Humidity | 5% - 95% RH non-condensing at 90°F 5% - 100% RH |
| 24VAC | 24 VAC ±20%, 50/60 Hz, Class 2 |
| Dimensions | 12" L x 12.5" W x 3.75" H |
| 4 RS485 ports | COM 1 = RS485-COM2A and RS485-COM2B COM 2 = RS485-COM6<ISOLATED> COM 3 = <ISOLATED>RS485 COM 4 = RS485-COM4A and RS485-COM4B |
| 2 Ethernet ports | ETH 0, ETH 1 |
| 2 USB ports | J2, J3 |
| External Pollution Rating | All Models: Pollution Degree 3 |
| Rated Impulse Voltage | 2500/4000V |
| Lithium Battery Marking | Warning: The cell used in this device may present a fire or chemical burn hazard if mistreated. Do not disassemble, heat above 212°F (100°C), or incinerate. |

Table 2-3 - E3 Technical Specifications

2.3 Plug-In Digital I/O Card (P/N 537-4880)

This card adds two user-programmable digital outputs and two digital inputs to enable connection of switches and relays (relay contacts are rated at 3A up to 24 VAC).

The plug-in Digital I/O Network card connects to the power interface board to the right of the two fixed RS485 I/O Network connectors.

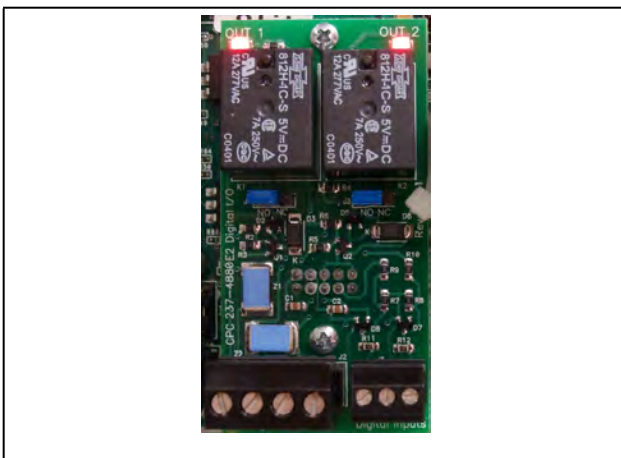

Figure 2-2 - Digital I/O Card

2.3.1 LED's

The plug-in Digital I/O Network card LEDs can be used to determine the status of normal operating parameters for the card.

| Plug-In Digital I/O Card LEDs | Status |
|-------------------------------|--------------------------|
| Red D1 (Out 1) | ON: Relay Output 1 is On |
| Red D4 (Out 2) | ON: Relay Output 2 is On |

Table 2-4 - LED Status for Plug-In Digital I/O Card

2.4 Wiring

1. Connect the RS485 Communication wire to the terminal block headers as shown. The Cables are numbered 1 through 4.
2. Connect the 2-pin 7.5mm power connector and Ground wire as shown in **Figure 2-7**
3. Connect the other end of the power cable to one of the 50VA P/N 640-0040 transformers.
4. Plug the 50VA P/N 640-0040 Transformers into a 120VAC outlet.
5. Turn the power switch "On". The unit should boot up to the home screen.
6. You can log into the unit the first time by using the below username and password if needed.
 - Username = user
 - Password = pass
7. Once logged in, you will be prompted to change your password.

2.5 Ethernet Connections

1. **ETH 0** is used to connect to corporate LAN.
2. **ETH 1** is designed to be used for directly connecting to PIB and laptop or PC and network devices. The default IP for **ETH 1** is **192.168.1.250**

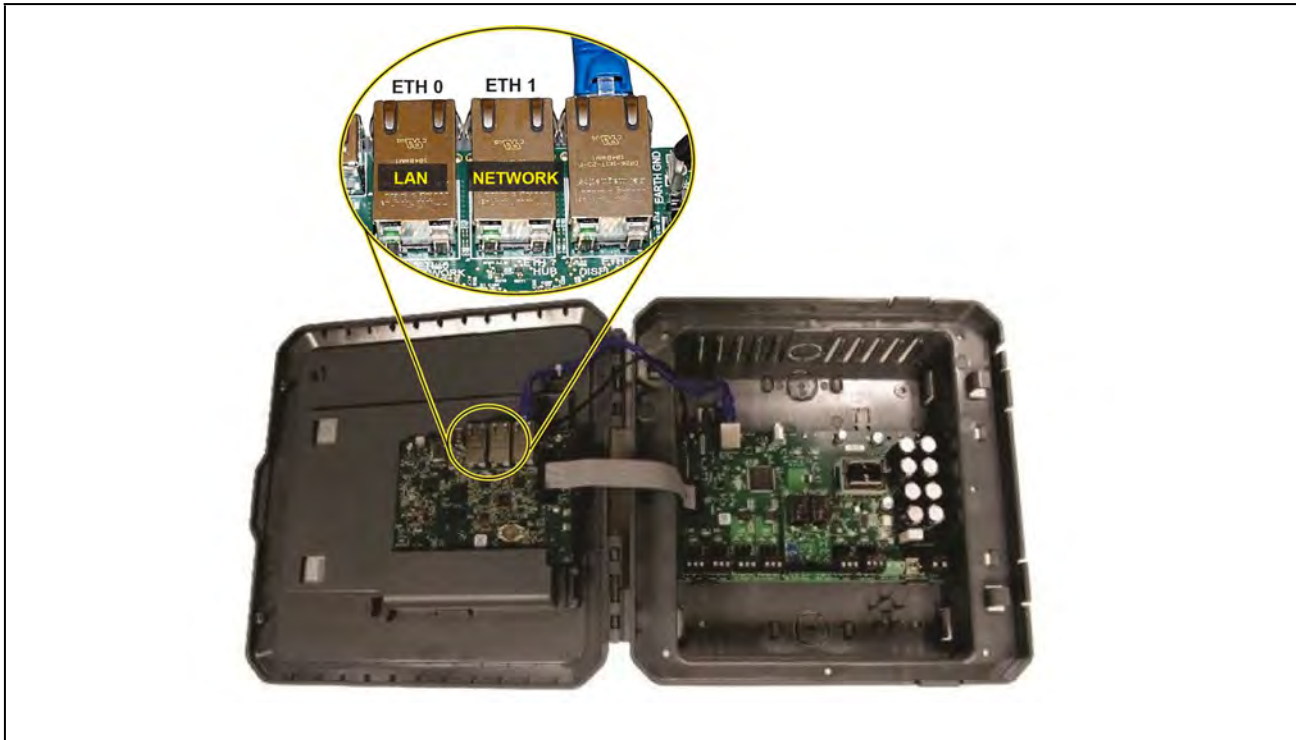

Figure 2-3 - E3 and Ethernet Connection

Note: When using an E3 Supervisory Controller with RS485 COM A and COM B Ports, ONLY the COM A port can be used for BACnet MSTP; the COM B port connector MUST remain unused for BACnet MSTP Networks. This is due to BACnet MSTP being a token passing network and all devices must be on the same physical network cable segment for successful token creation and passing.

2.6 E3 RS485 Wiring Guide Example

- For E3 Serial IO Net connections, connect the white wire to the positive terminal and the black wire to the negative terminal.
- For 8RO and MultiFlex RS485 IO Net connections, connect the white wire to the positive terminal and the black wire to the negative terminal.
- Connect the shield wire to earth/chassis at the end of the IO Net (network) segment. Connect the shield wire to the center terminal (0V) of the IO Net connector on the E3.
- For daisy-chain configurations, terminate devices at the beginning and the end of the network segment.
- All other devices in the network segment are not terminated (termination jumpers in the not-terminated position).

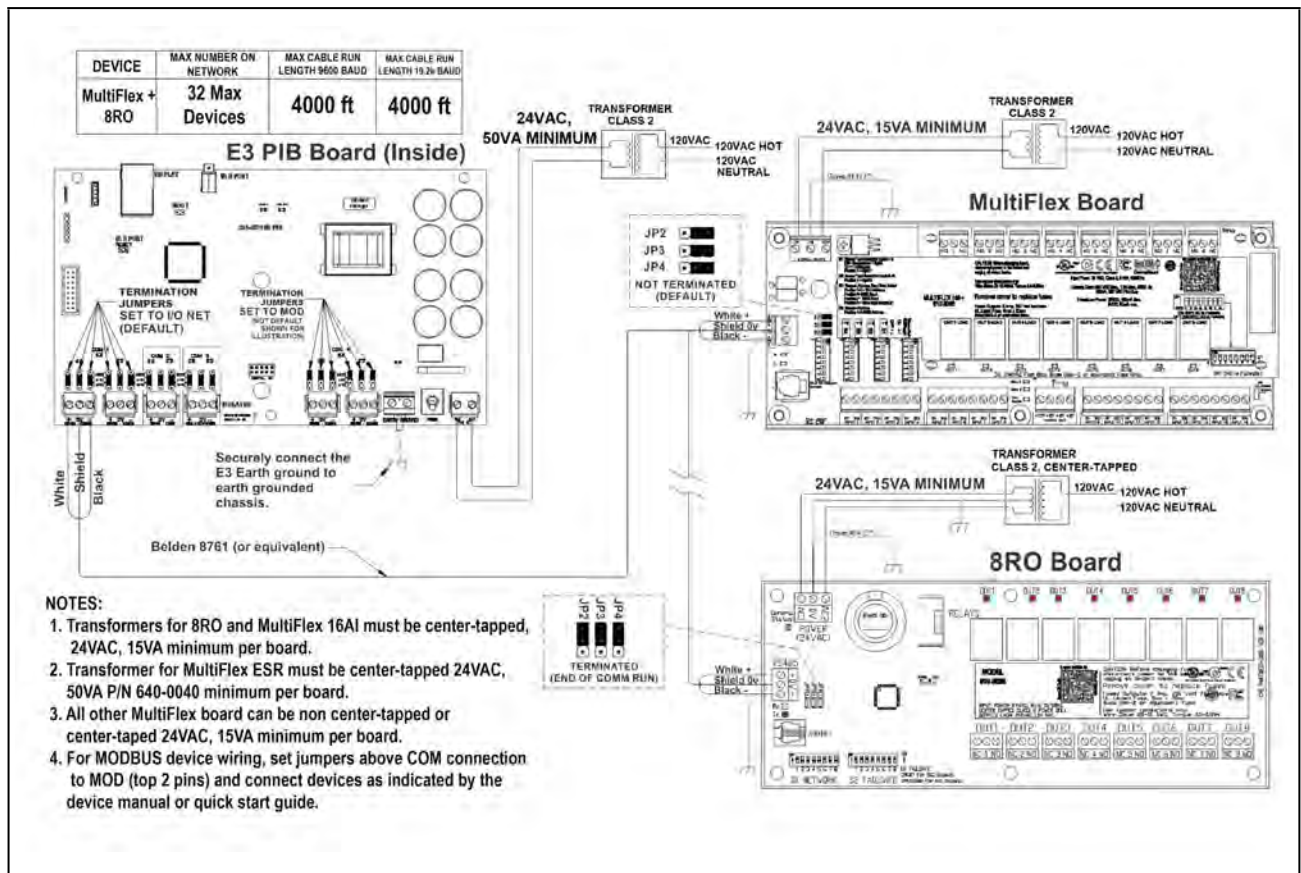

Figure 2-4 - E3, MultiFlex, and 8RO Wiring Layout

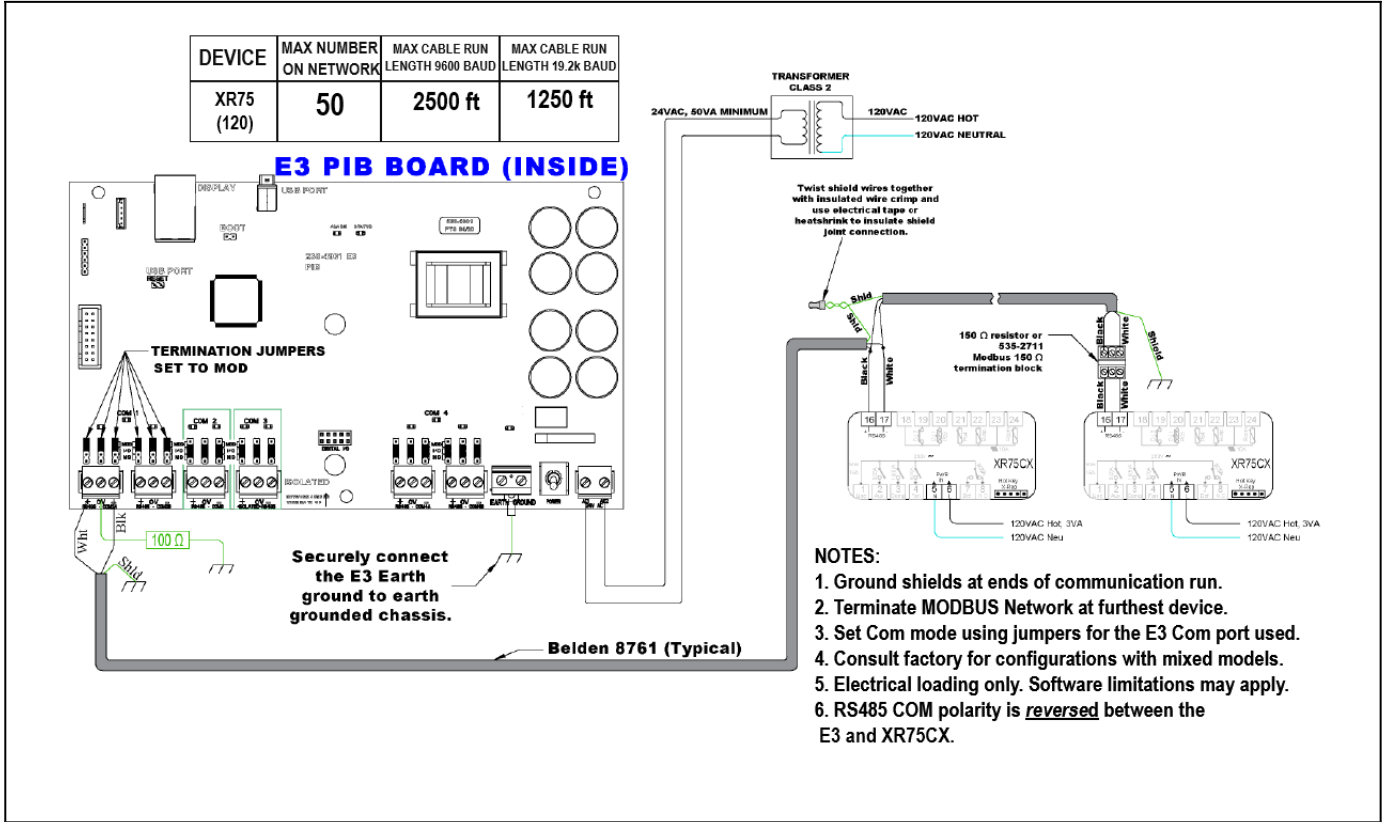

Figure 2-5 - E3 and XR75 Wiring

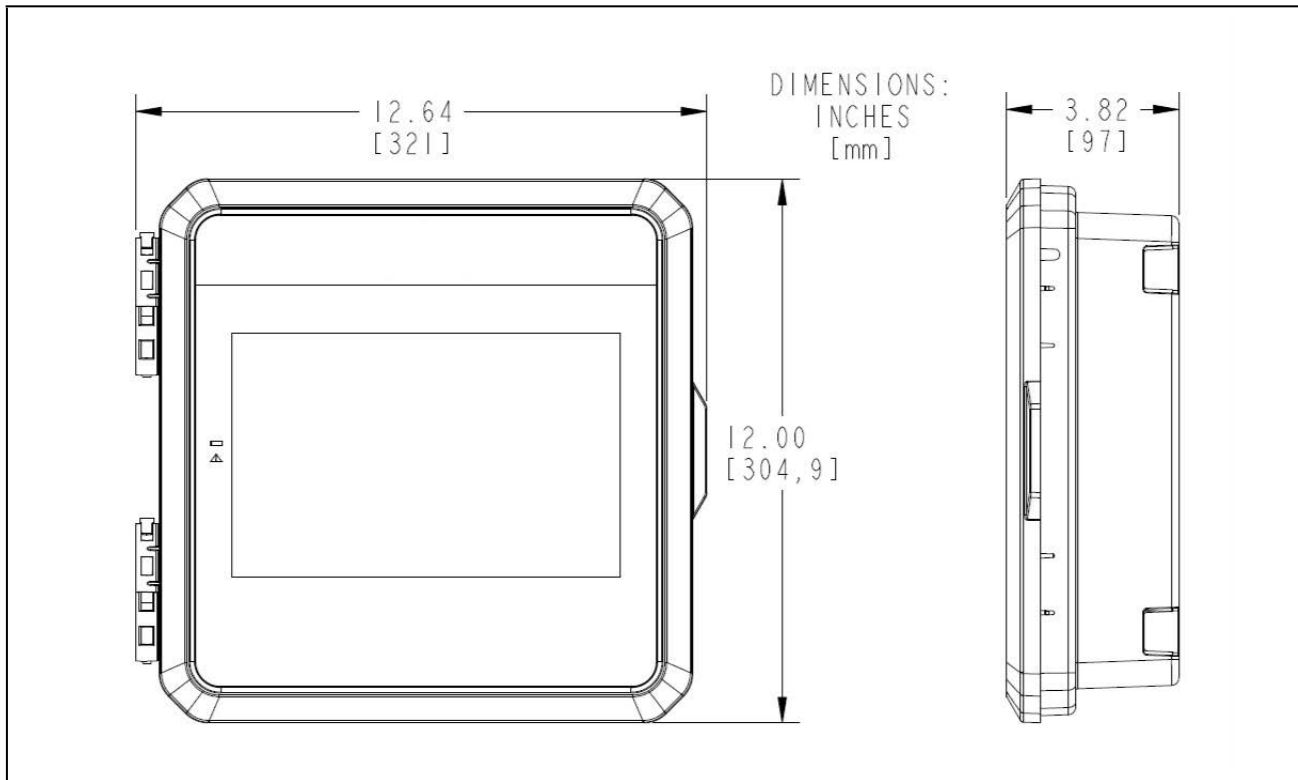

Figure 2-6 - E3 Dimensions

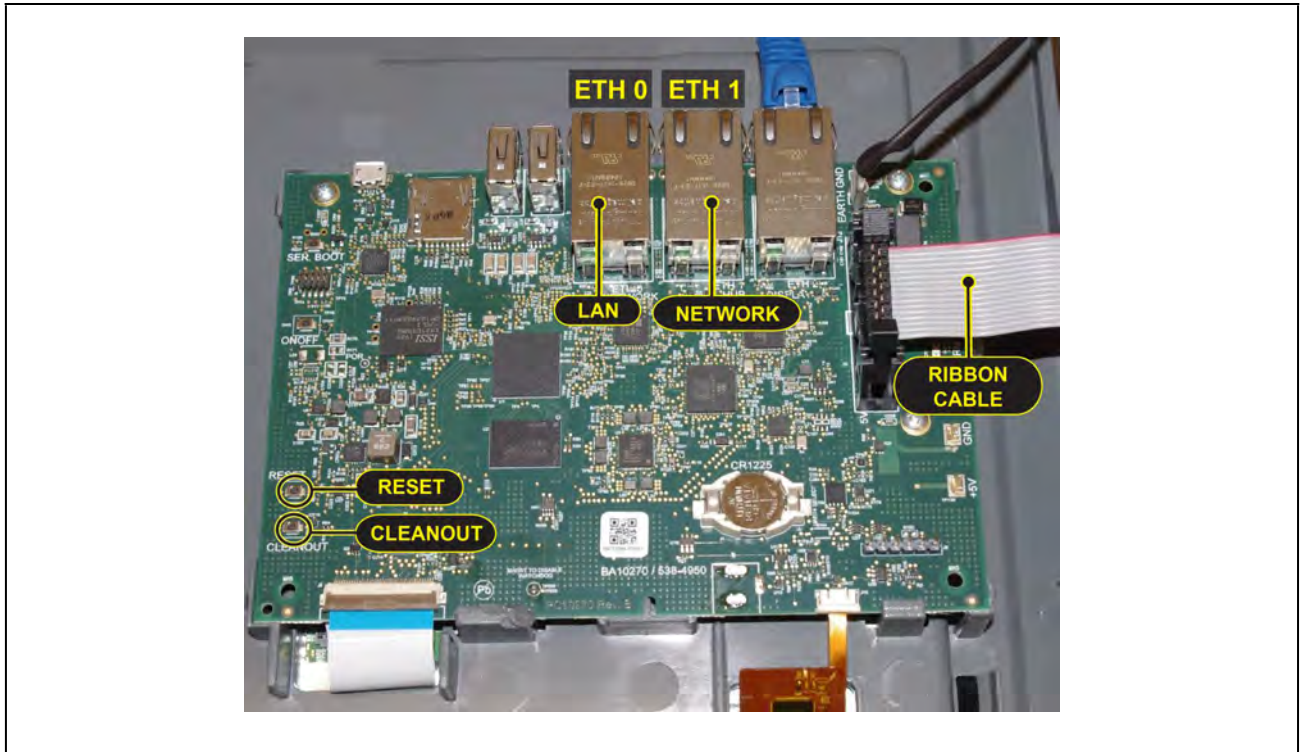

Figure 2-7 - E3 Circuit Board

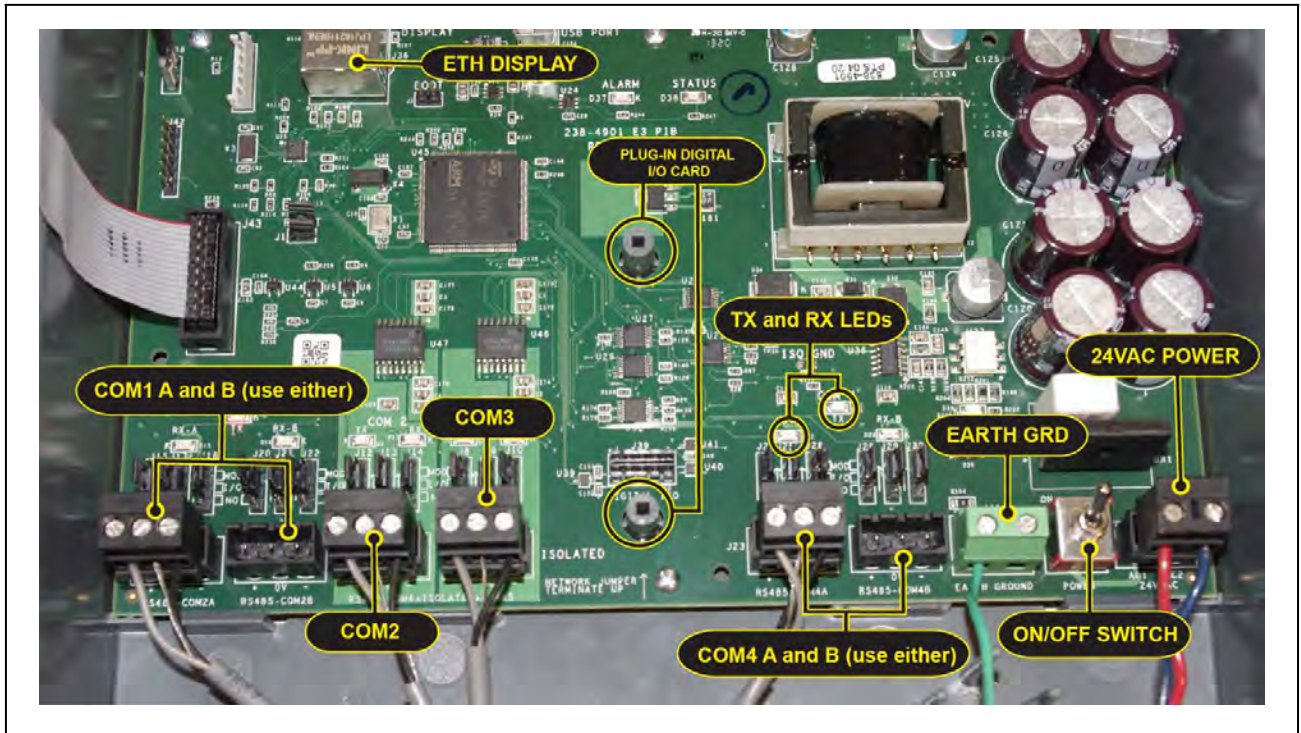

Figure 2-8 - E3 PIB

2.7 E3 Wiring Diagrams

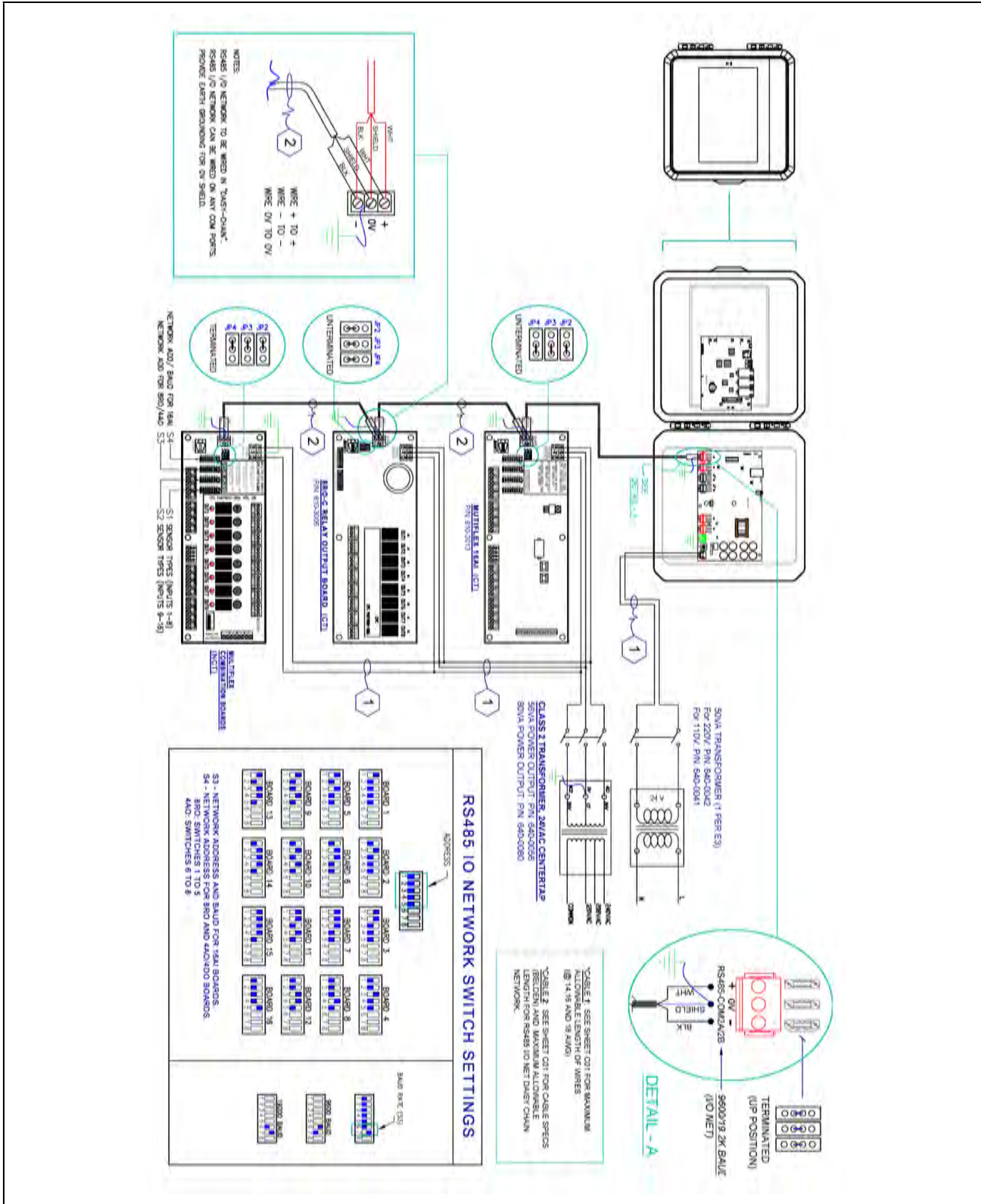

Figure 2-9 - E3 and MultiFlex Board

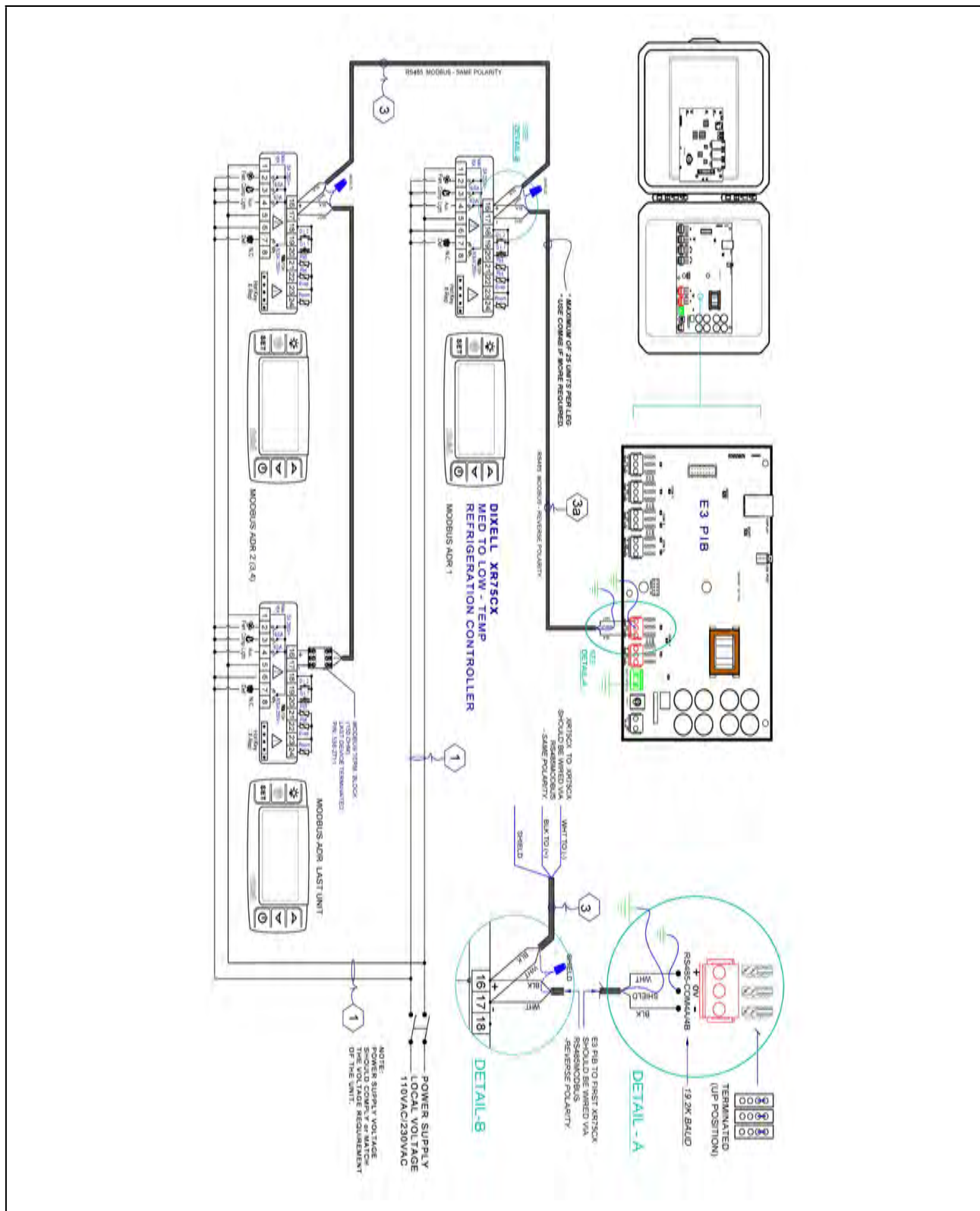

Figure 2-10 - E3 and XR75CX

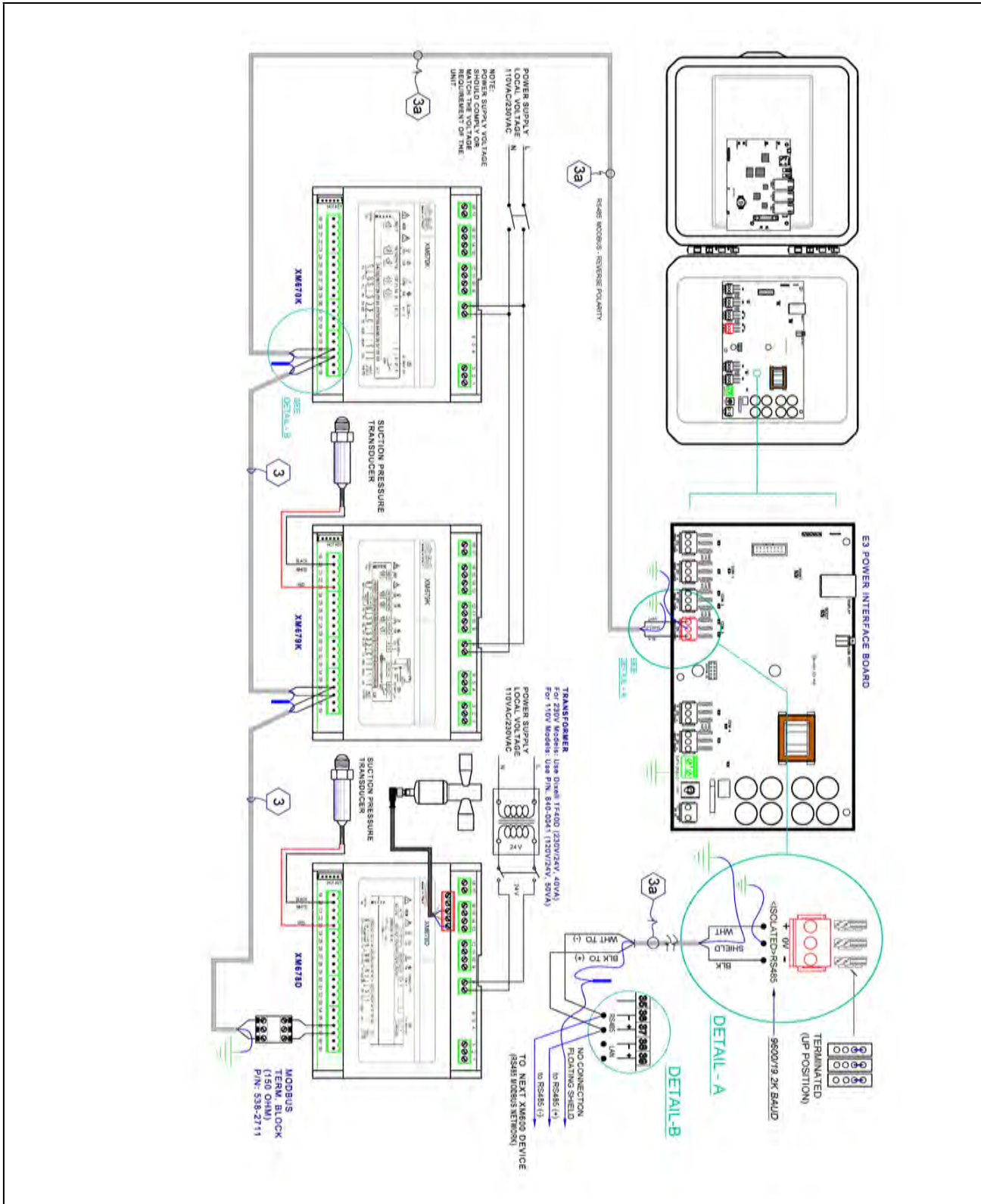

Figure 2-11 - E3 and XM678 and XM679

3 Site Supervisor Hardware Overview



Figure 3-1 - Site Supervisor

Site Supervisor is a Supervisory Controller system that combines energy management with the ability to monitor various facility systems and provide alerts when there are issues that need attention. This system provides HVAC control, Refrigeration System Monitoring and Control, as well as Lighting Control. In addition, the Supervisory Controller can monitor and report energy consumption and take action to reduce the energy demand during peak periods. This can have a direct impact on utility bills by reducing total energy costs. Supervisory controllers ensure that the HVAC and lighting systems are on and off at the appropriate times. This ability to monitor store conditions can potentially minimize energy consumption.

3.1 Ordering information

| | | |
|----------|---------------------|--|
| 860-1200 | Site Supervisor SF | Small Format |
| 860-1220 | Site Supervisor RX | Refrigeration Controller 300 Level |
| 860-1225 | Site Supervisor RXe | Refrigeration Controller 400 Level |
| 860-1240 | Site Supervisor BX | Building Controller 300 Level |
| 860-1245 | Site Supervisor BXe | Building Controller 400 Level |
| 860-1260 | Site Supervisor CX | Convenience Store Controller 300 Level |
| 860-1265 | Site Supervisor CXe | Convenience Store Controller 400 Level |

Table 3-1 - Site Supervisor Ordering Part Numbers

Note: For complete product part numbers and accessory ordering information, contact your Copeland Sales representative or Customer Service.

3.2 Technical Specifications

| | |
|-----------------------|--|
| Operating Temperature | -40°F to 149°F (-40°C to 65°C) |
| Relative Humidity | 20-85% RH, non-condensing |
| Enclosure Rating | UL 94 V-0 |
| Dimensions | L 7 3/16 x W 2 3/8 x H 4 5/16 (183mm x 60mm x 110mm) |
| Power In | 24VAC 50/60 Hz +/- 10% 20VA 24VDC +/- 10% .8A |
| 1 Can Bus | Expansion Module Connections Only |
| 4 RS485 ports | MODBUS Com Ports 1, 2, 3, and 4 |
| 3 Ethernet ports | Ports 1, 1, 0 |
| Analog Inputs | 8 |
| 2 USB Ports | 1, 2 |
| MicroSD | 1 |
| Digital Inputs | 4 |
| Relay Outputs | 4 |
| Agency Approvals | ULE211299, CE   |

Table 3-2 - Site Supervisor Specifications

3.3 Site Supervisor Housing Dimensions and Mounting

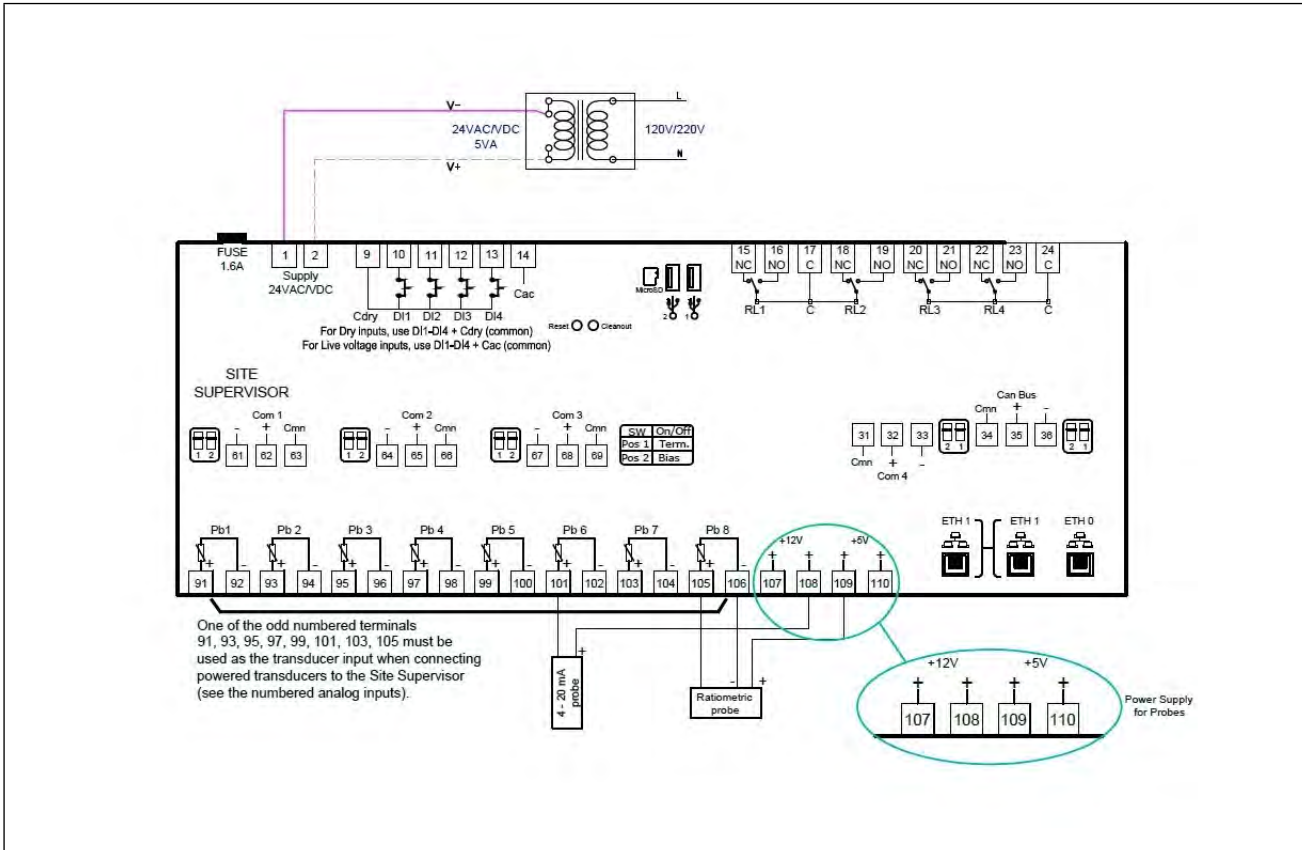

Figure 3-2 - Site Supervisor Housing Dimensions and Mounting

The Site Supervisor can be mounted to standard 35mm DIN rail using the orange mountain clips.

It can also be screwed to a back plate by pulling the four (4) orange mounting tabs out until they lock, which will expose mounting holes.

3.4 Wiring Diagrams

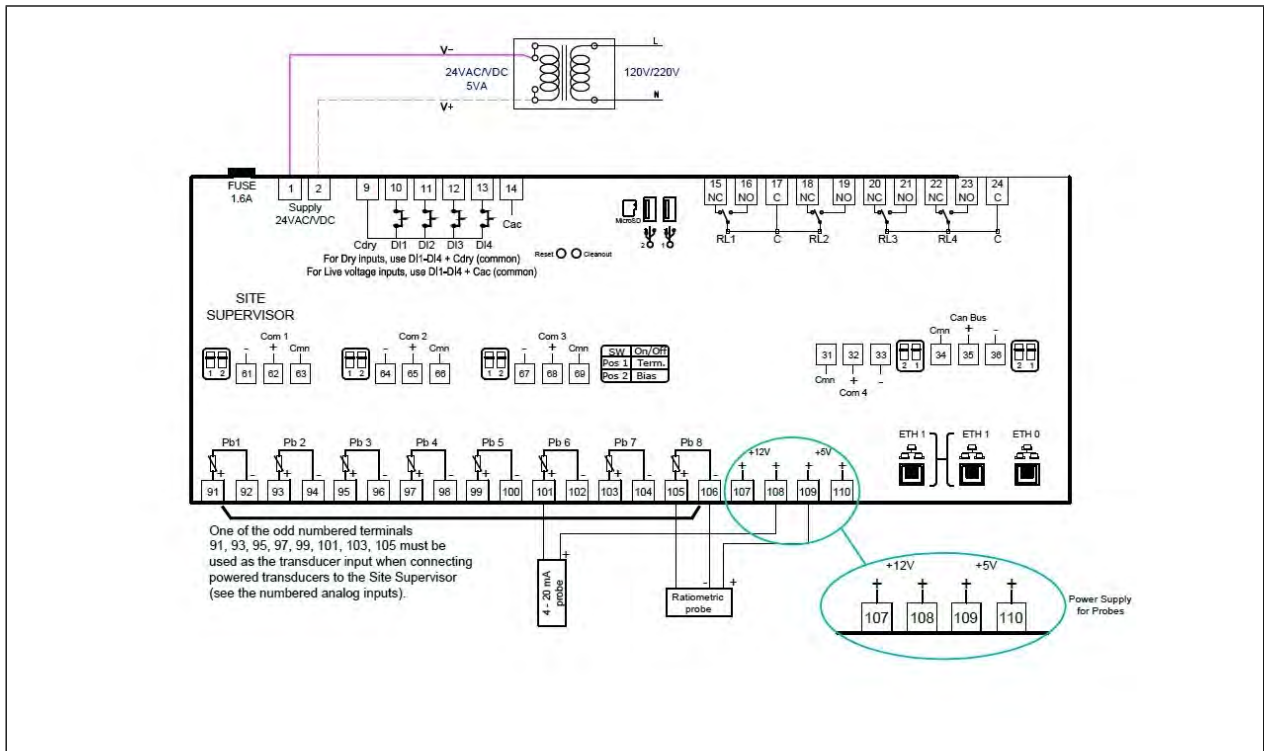

Figure 3-3 - Site Supervisor Controller Wiring Diagram



Figure 3-4 - Site Supervisor Detail

3.5 Device Wiring

See **Section 3.12**, *Site Supervisor Wiring Examples* for typical power and COM wiring.

3.6 Site Supervisor Power, Serial, and IO Positions

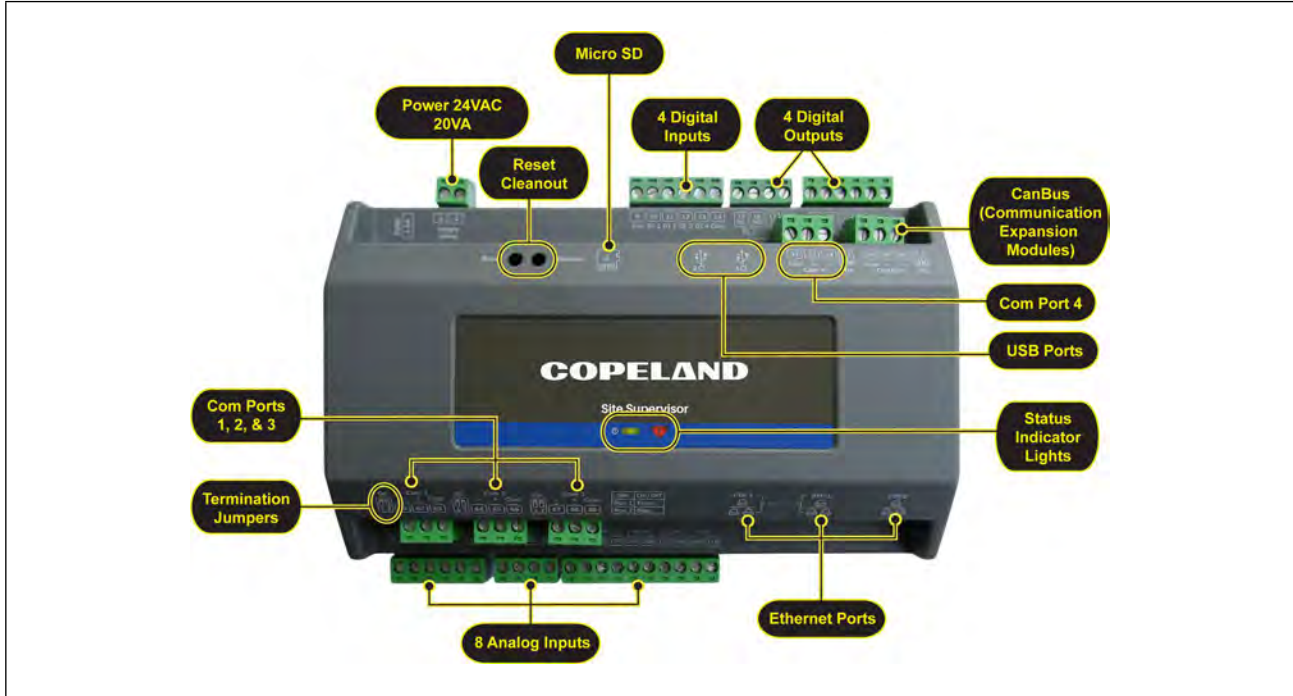

Figure 3-5 - Site Supervisor Power, Serial, and IO Positions

3.6.1 Termination Jumpers

Depending on the orientation of the board, the termination jumpers are set in the down position (*always toward the board - ON*) for termination and up (*always away from the board - OFF*) for no termination. Position 1 = Termination and Position 2 = Bias. Refer to the enclosure diagram for termination jumper direction.

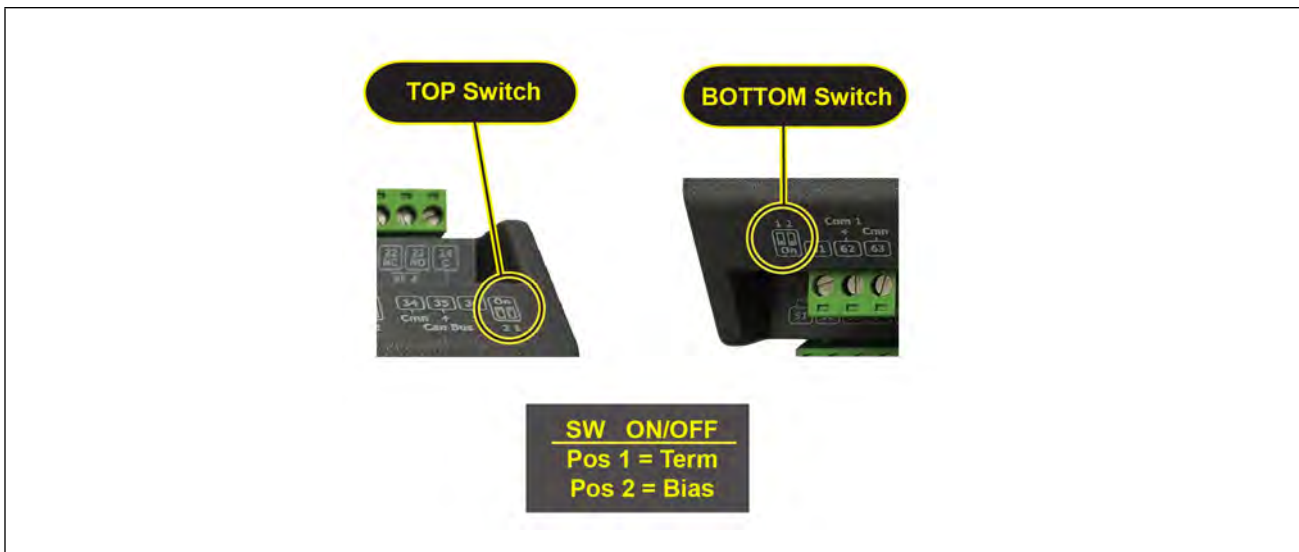

Figure 3-6 - Termination Jumper/Dip Switch Positions

3.6.2 Using a DC Volt Meter to Check Termination and Bias

Unplug connector from the Site Supervisor Serial port and make DC voltage measurements on the Serial port pins. Place the meter common probe on the Serial **Comm** pin and measure voltage on the Serial port "+" pin and the Serial port "-" pin. See the table below for expected voltages.

| Term | Bias | Serial + | Serial - |
|------|------|----------|----------|
| OFF | ON | 5Vdc | 0Vdc |
| ON | ON | 2.7Vdc | 2.3Vdc |
| OFF | OFF | *2.4Vdc | *2.4Vdc |

Table 3-3 - Termination and Bias Voltages

**Note that for both Termination and Bias OFF, the voltage on both pins are undetermined but typically equal and near 2.4Vdc.*

3.6.3 Removing The SD Card

If present, the user can manage the SD card or USB drive in order to upgrade controller firmware, set the Ethernet TCP/IP configuration, and read the Ethernet TCP/IP settings. The SD card must be inserted in the SD socket. To remove the SD card safely from the Site Supervisor without shutting down, click **Safely Remove** under **File Management** and remove the SD card from the socket.



Figure 3-7 - Safely Remove the SD Card

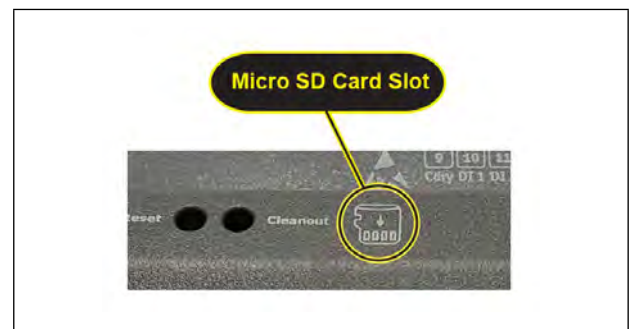

Figure 3-8 - Micro SD Card Slot

CAUTION! DO NOT remove the cover. Removing the cover will void the warranty.

3.6.4 LEDs



Figure 3-9 - LEDs on Front Enclosure

| STATE | DESCRIPTION |
|---------------------|-------------------------|
| Solid red | Starting up |
| Flashing red - 1 Hz | Loading OS/Application |
| Solid green | Running - Normal Status |
| Flashing red - 2 Hz | Failure to load |

Table 3-4 - LED States and Definitions

3.6.5 Dip Switch Termination and Biasing

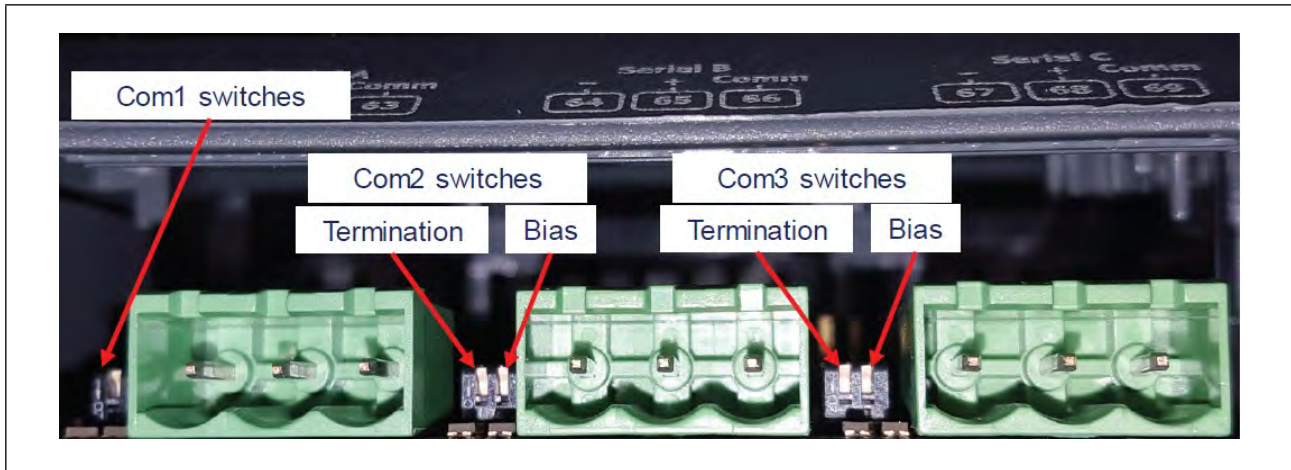

Figure 3-10 - Dip Switch Configuration

The termination and biasing dip switches are located to the left of their respective communications port connectors. The switches are oriented such that switch down is ON for the function. The dip switches are of the “piano key” type and must be moved up and down when they are viewed as shown above.

The termination dip switch must be ON (down) when the Site Supervisor is the first or last device on the RS485 network, most easily recognized by having only 1 Belden style cable attached to the connector.

What is biasing?

The transmission line into the RS-485 serial port enters an indeterminate state when it is not being transmitted to. This indeterminate state can cause the receivers to receive invalid data bits from the noise picked up on the cable.* To prevent this, set the bias dip switch to ON (down) which will add the appropriate amount of resistance.

*Source: *National Instruments Serial Troubleshooting Wizard*



NOTE: The switches are somewhat fragile and care should be taken when switching them from ON to OFF or vice versa. It is also likely that a small control screwdriver needs to be used because of space and clearance between the COM port connectors, and you must ensure that power to the controller is secured prior to changing the switch position(s). It is highly recommended that the controller be removed from its enclosure or panel (if installed) so that ample light and line of sight can be obtained during this procedure. An example of a broken dip switch can be seen below.

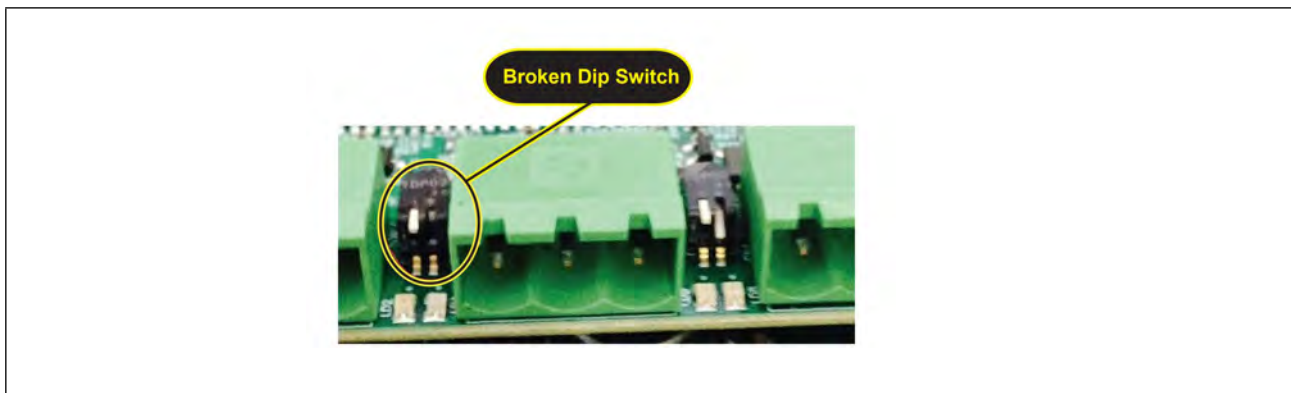

Figure 3-11 - Broken Dip Switch

3.7 Serial Connections

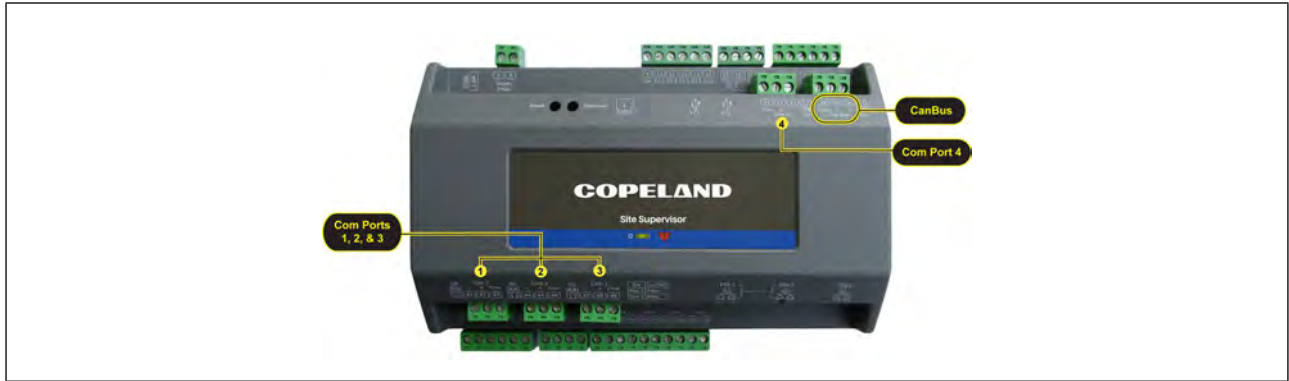

Figure 3-12 - Serial Connections

Supervisory controllers are equipped with four (4) RS485 serial Com ports and one (1) Can Bus port.

- Com ports 1-4 support MODBUS and IO Net.
- Com ports 1-4 support 9600, 19200, 38400, 57600, and 115200 baud connection speeds.
- The Can Bus port is for expansion I/O such as the IPX206D and IPX225D.
- Com ports 1-4 wiring polarity:
 - Same polarity - XR75CX, Energy Meter.
 - Opposite polarity - T-Stat, Control Link ACC, MRLDS, all I/O boards including MultiFlex and legacy boards.

3.8 Wiring Terminal Detail

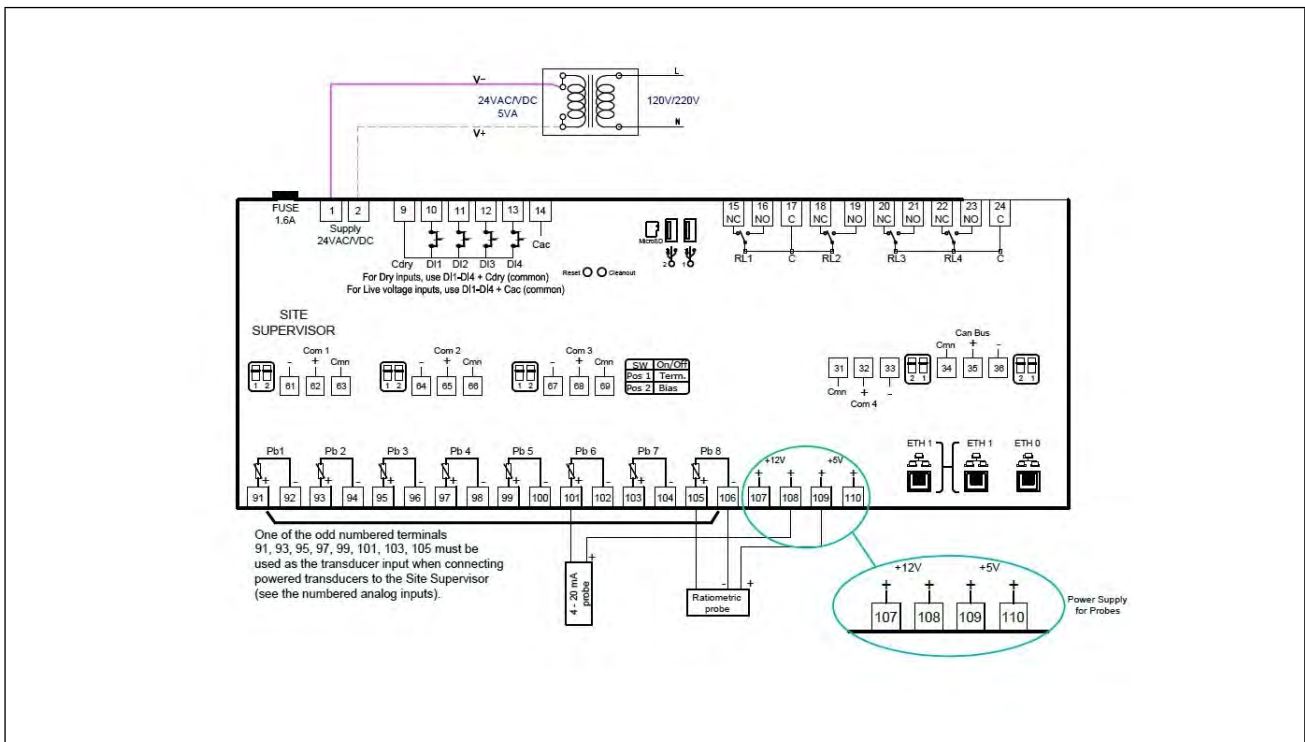

Figure 3-13 - Site Supervisor Wiring Terminal Detail

3.9 Digital Inputs

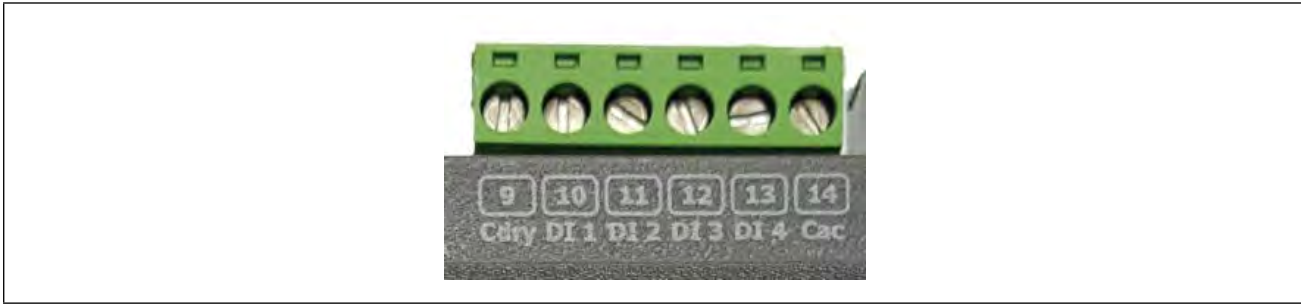

Figure 3-14 - Digital Inputs

- Can read both dry and wet (24VAC) contact closures
- Dry contact wire to DI 1 - DI 4 and Cdry
- Wet (live) contact wire to DI 1 - DI 4 and Cac
- Can read pulses up to 10Hz

3.10 Relay Outputs

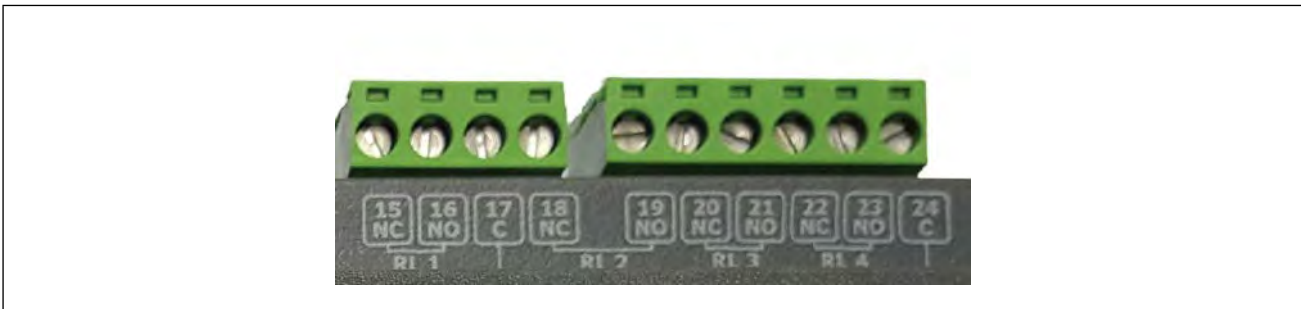

Figure 3-15 - Relay Outputs

- Relays are Form C rated 5A at 120V/240VAC
- General Purpose



NOTE: General purpose relays are cost-effective 5-15 Amp switching devices used in a wide variety of applications.

Features:

- Electrical loads of 5 to 15 Amps.
- Contact configurations through 3PDT.
- Coils molded in polyester for environmental protection.

- 100K Cycles
- Pin 17 is common for relays 1 & 2
- Pin 24 is common for relays 3 & 4
- Relay 1 (RL 1) - Pin 15 NC / Pin 16 NO
- Relay 2 (RL 2) - Pin 18 NC / Pin 19 NO
- Relay 3 (RL 3) - Pin 20 NC / Pin 21 NO
- Relay 4 (RL 4) - Pin 22 NC / Pin 23 NO

3.11 Analog Inputs

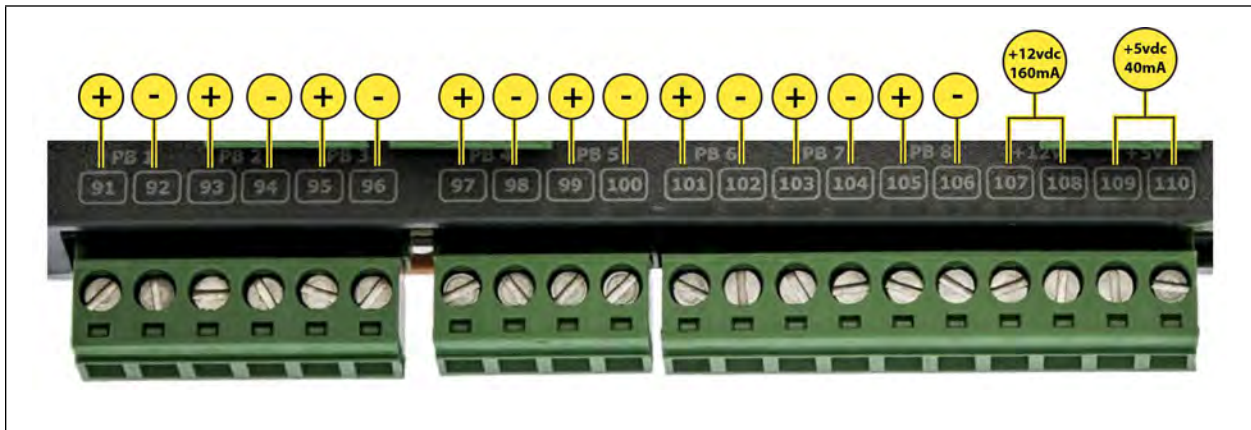

Figure 3-16 - Analog Inputs

- Supports 0-10VDC, 0-1 DC, 0-5VDC, 2-20mA, 4-20mA, NTC temperature and dry contact digital input.
- Supports engineering units for temperature, pressure, humidity, light level and generic percentage.
- When wiring transducers or amplifiers (for example, outdoor light level) the odd numbered terminal is the + or signal and the even numbered terminal is the - or common.
- Provides (2) 12VDC (160mA) and (2) 5VDC (40mA) power supply terminals for humidity sensors, pressure transducers, and more.

| Type | Ratings | Terminal |
|-----------------------|--|-------------------------------|
| Relay 1 (N.O. & N.C.) | 5A, 125/240 VAC, General Purpose, 100K cycles; 4FLA/4LRA, 250VAC, Motor Load, 100K cycles | J5-2, J5-3, J5-4 (Base Board) |
| Relay 2 (N.O. & N.C.) | 5A, 125/240 VAC, General Purpose, 100K cycles; 4FLA/4LRA, 250VAC, Motor Load, 100K cycles | J5-1, J5-2, J6-6 (Base Board) |
| Relay 3 (N.O. & N.C.) | 5A, 125/240 VAC, General Purpose, 100K cycles; 4FLA/4LRA, 250VAC, Motor Load, 100K cycles | J6-1, J6-4, J6-5 (Base Board) |
| Relay 4 (N.O. & N.C.) | 5A, 125/240 VAC, General Purpose, 100K cycles; 4FLA/4LRA, 250VAC, Motor Load, 100K cycles | J6-1, J6-2, J6-3 (Base Board) |

Table 3-5- UL Relay Ratings

3.12 Site Supervisor Wiring Examples

- Site Supervisor IONet connections must be wired reverse polarity.
- For Site Supervisor Serial IONet connections, connect the white wire to the negative terminal and the black wire to the positive terminal.
- For 8RO and MultiFlex RS485 IONet connections, connect the white wire to the positive terminal and the black wire to the negative terminal.
- Connect the shield wire to earth/chassis at the Site Supervisor end of the IONet network segment. DO NOT connect the shield wire to any connector on the Site Supervisor.
- For daisy-chain configurations, terminate devices at the beginning and the end of the network segment. All other devices in the network segment are not terminated (termination jumpers in the not-terminated position).

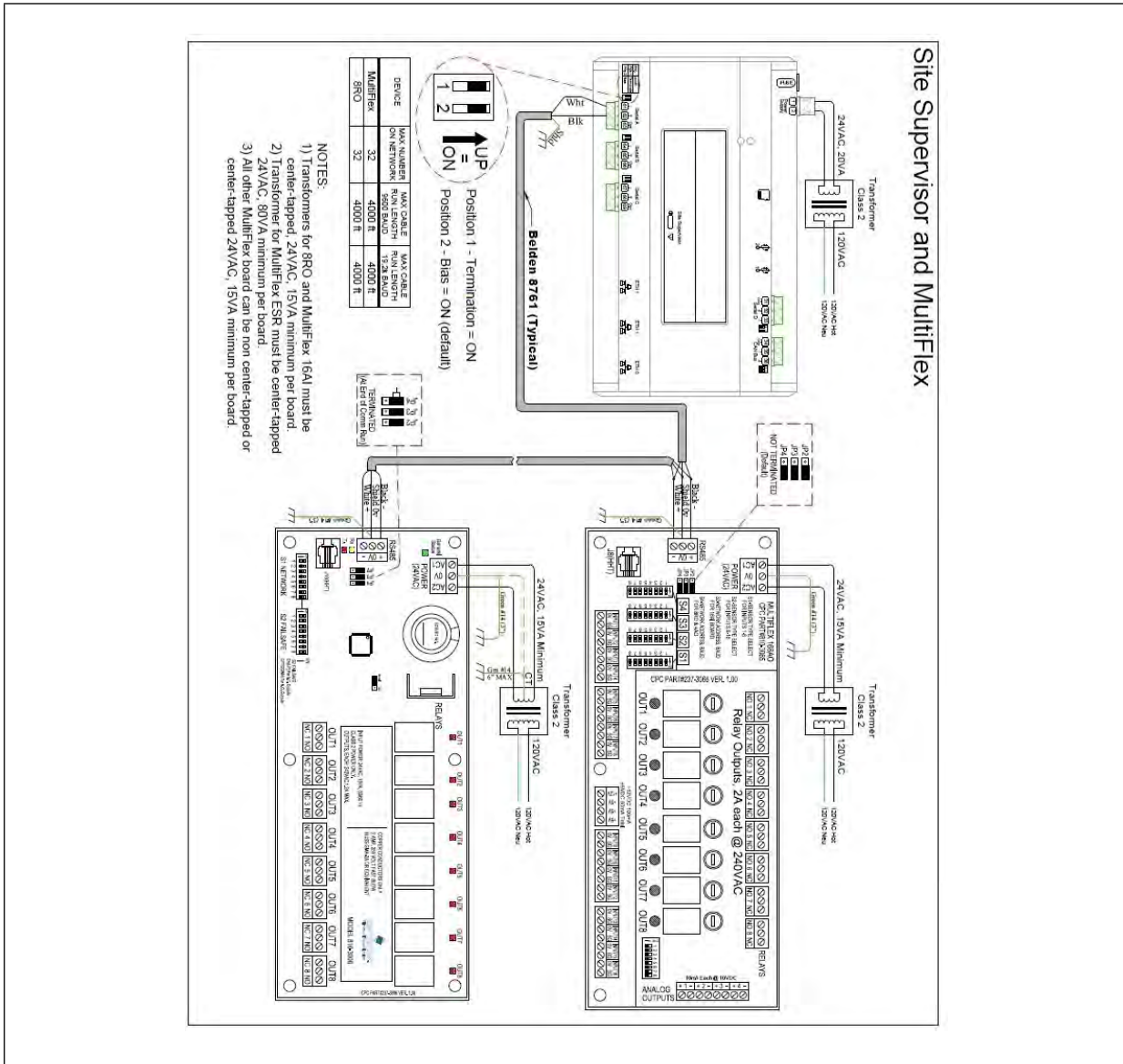

Figure 3-17 - Supervisory Controller and MultiFlex Wiring

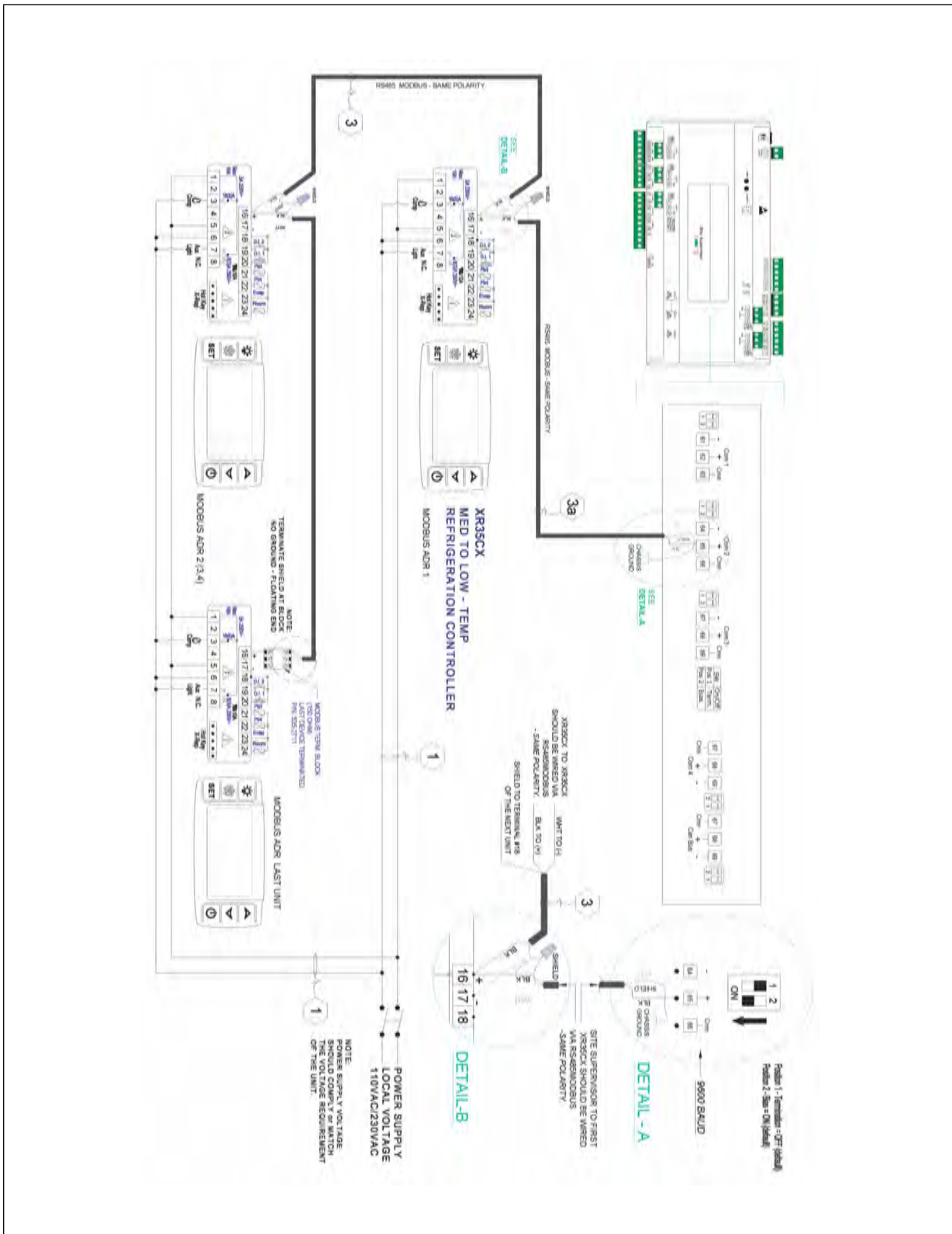

Figure 3-18 - Supervisory Controller and XR35CX Wiring

- Site Supervisor and XR75CX share the same MODBUS network polarity. Do not reverse polarity.

- Connect the shield wire to earth/chassis at the Site Supervisor end of the MODBUS network segment. Do not connect the shield wire to any connector on the Site Supervisor or XR75CX.
- For daisy-chain configurations, terminate devices at the beginning and the end of the network segment. Set the dip switch position 1 and 2 to the ON position on Site Supervisor. For XR75CX end of network, terminate with a 150-ohm resistor or 535-2711 termination block. All other devices in the network segment are not terminated.

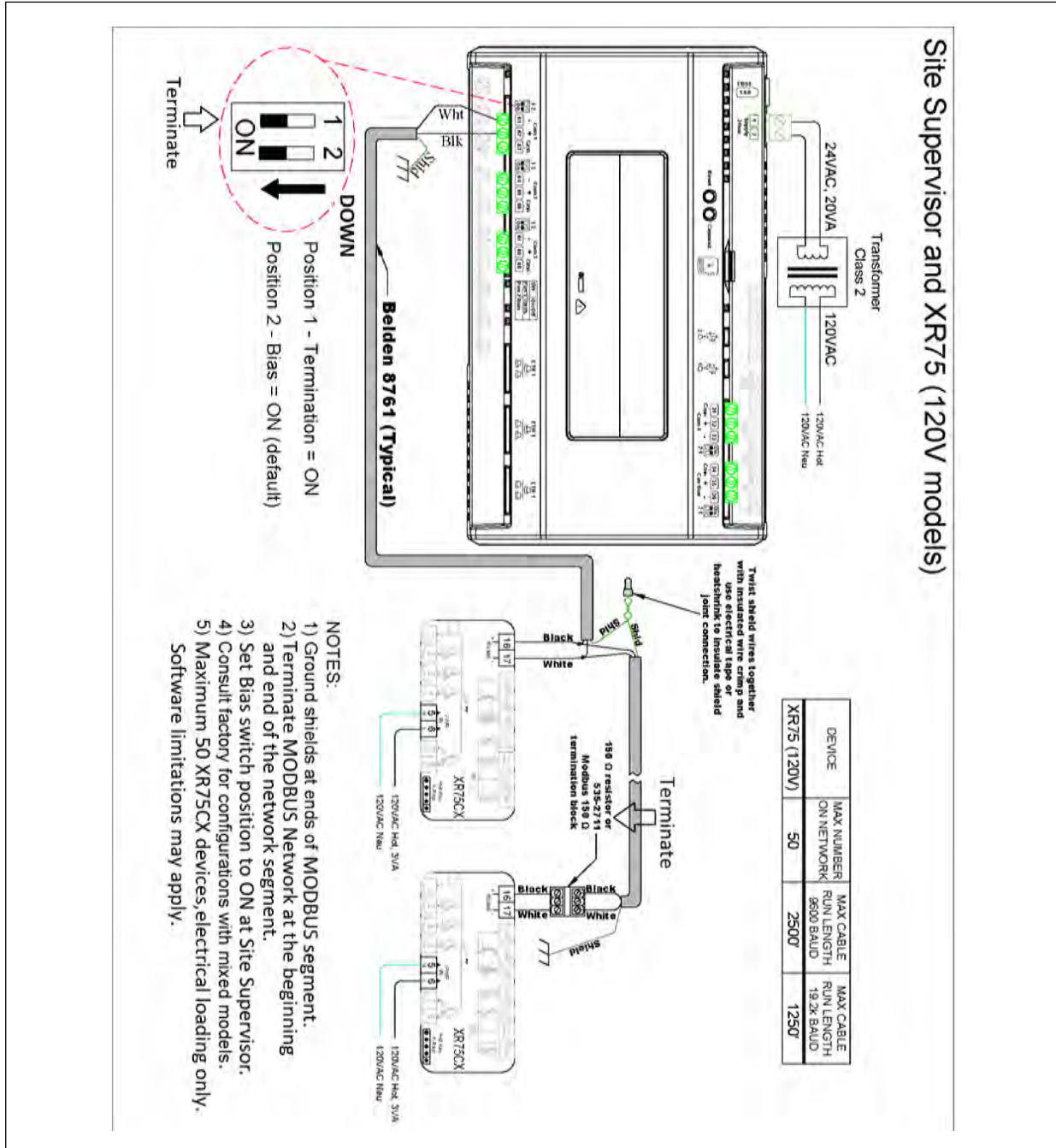

Figure 3-19 - Supervisory Controller and XR75CX Wiring

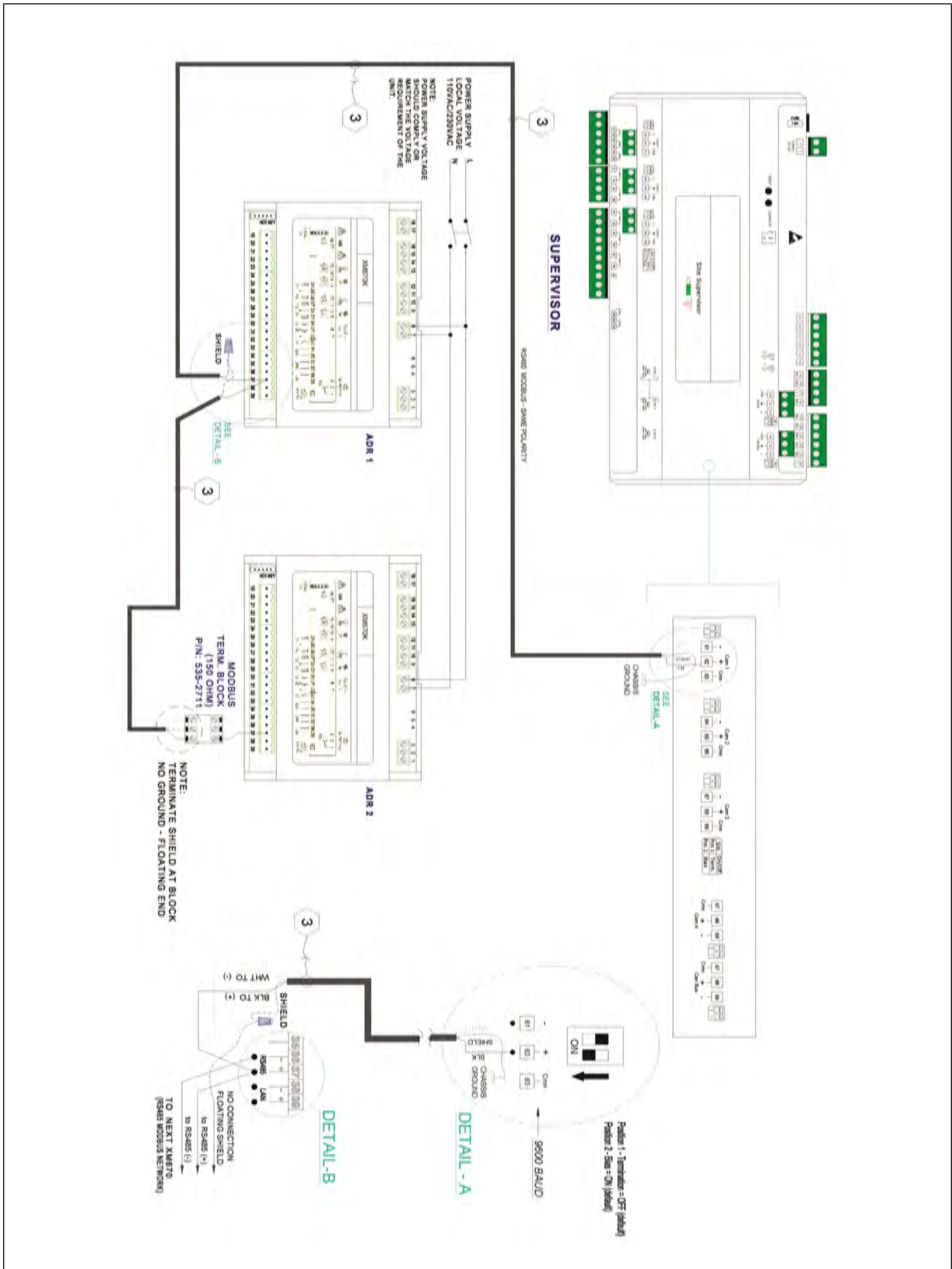

Figure 3-20 - Supervisory Controller and XM670 Wiring

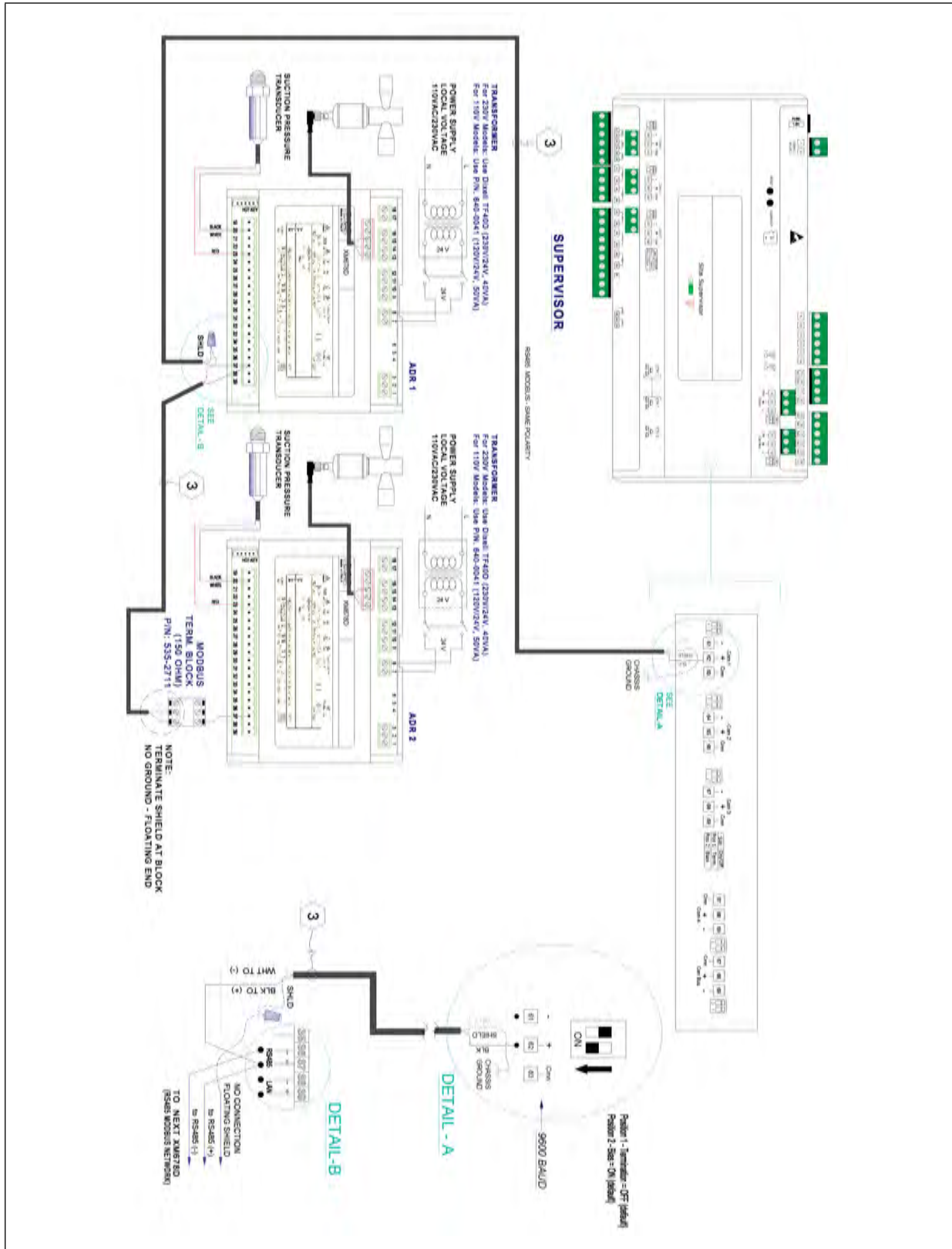

Figure 3-21 - Supervisory Controller and XM678 Wiring

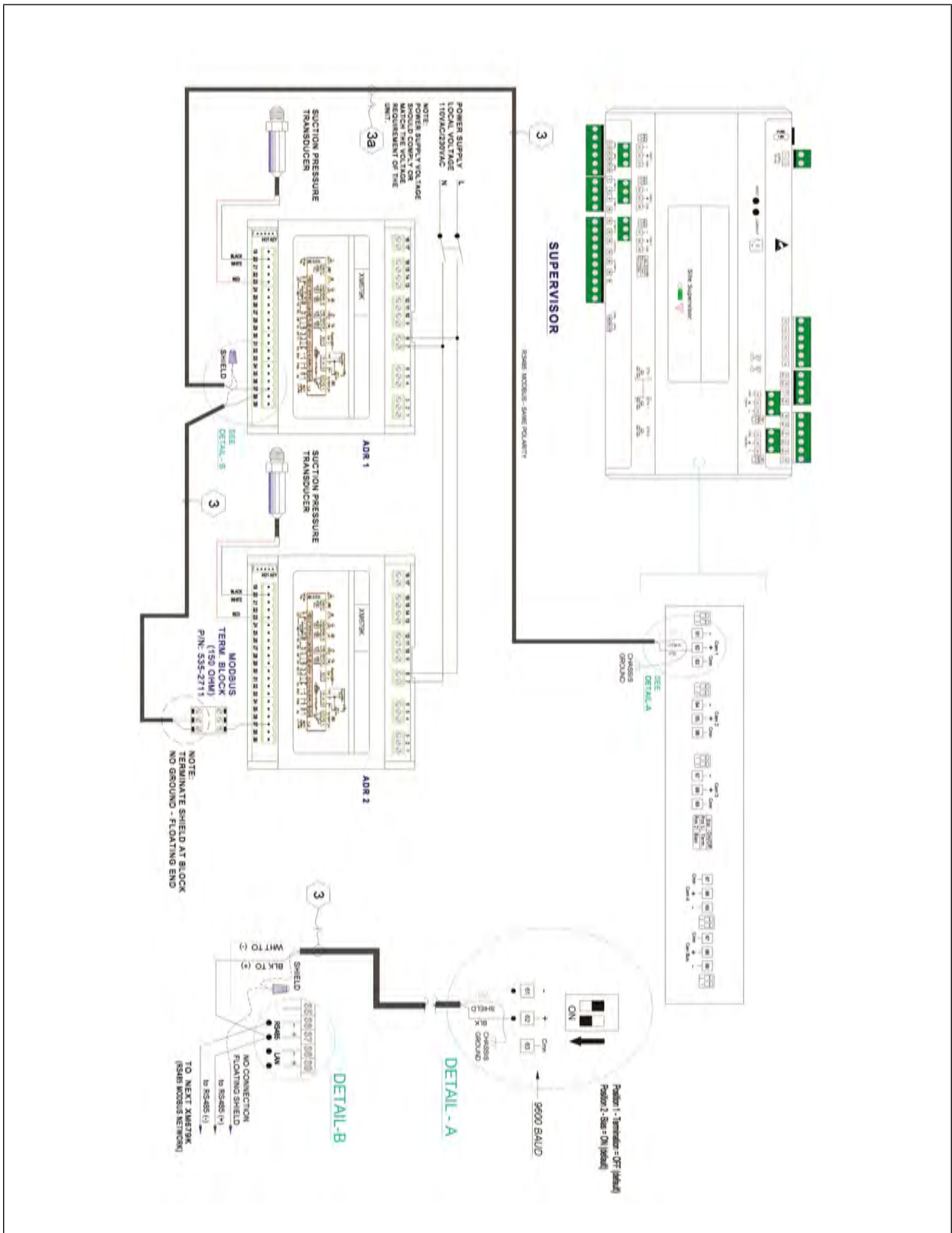

Figure 3-22 - Supervisory Controller and XM679 Wiring

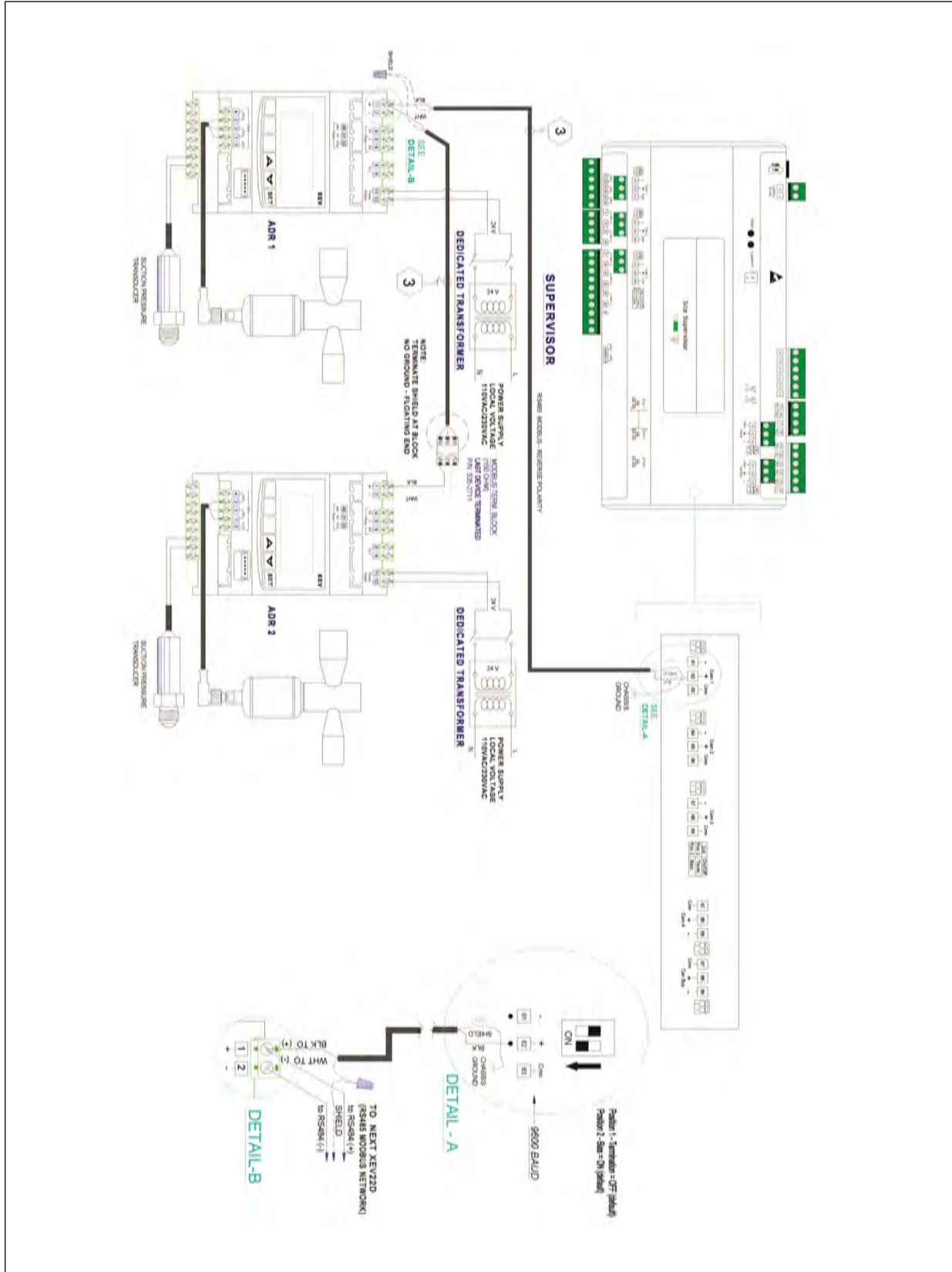

Figure 3-23 - Supervisory Controller and XEV22 Wiring

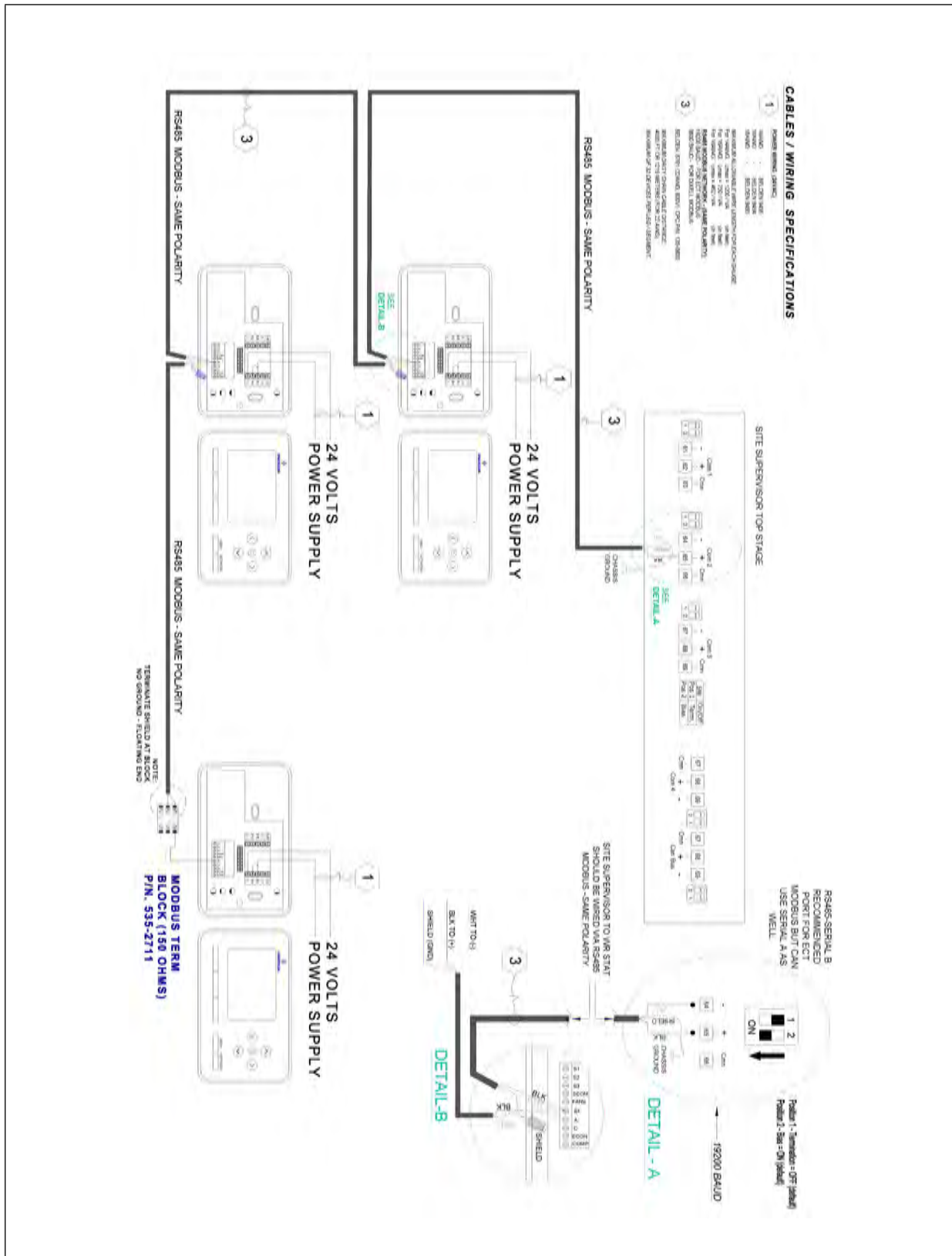

Figure 3-27 - Supervisory Controller and Thermostat Wiring

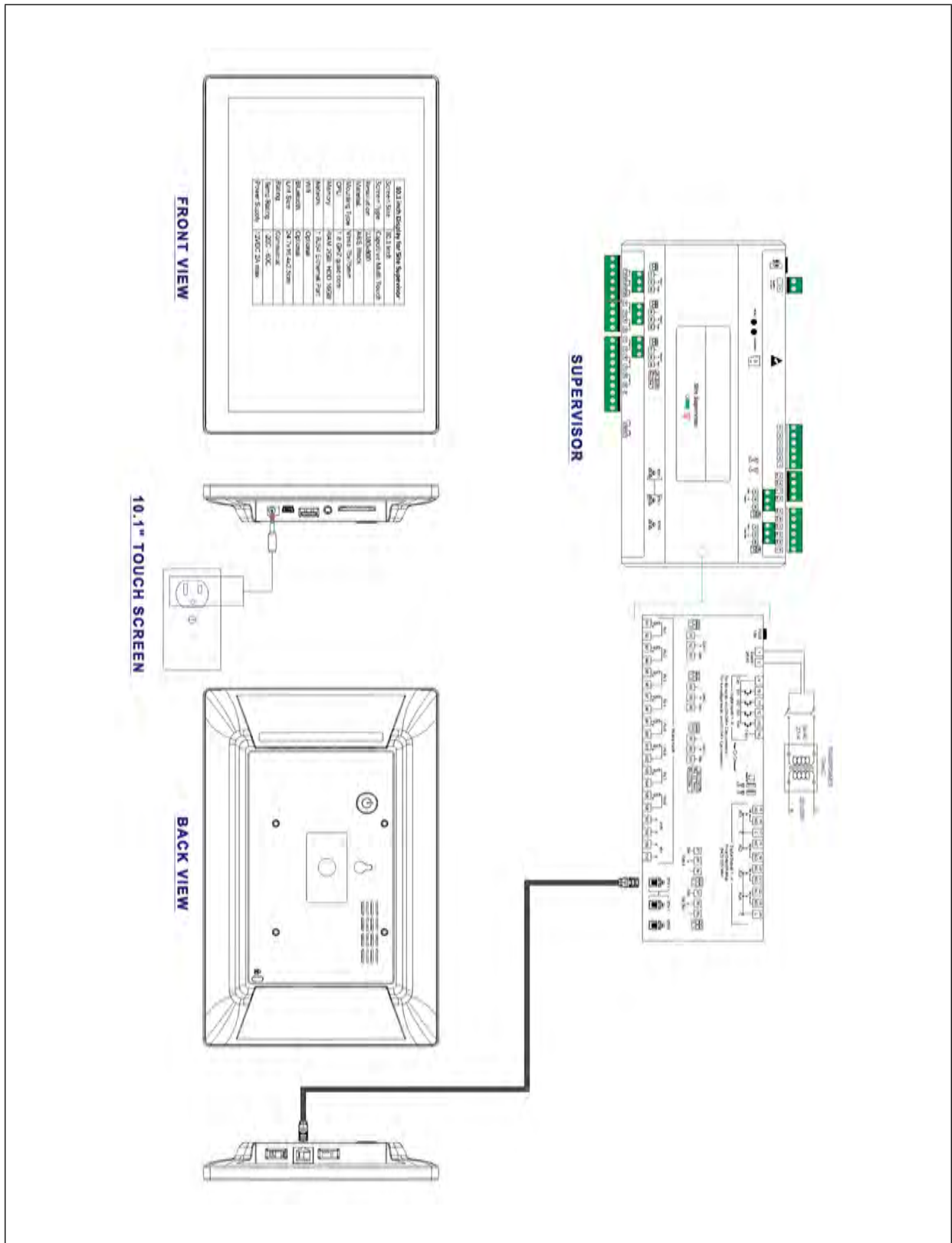
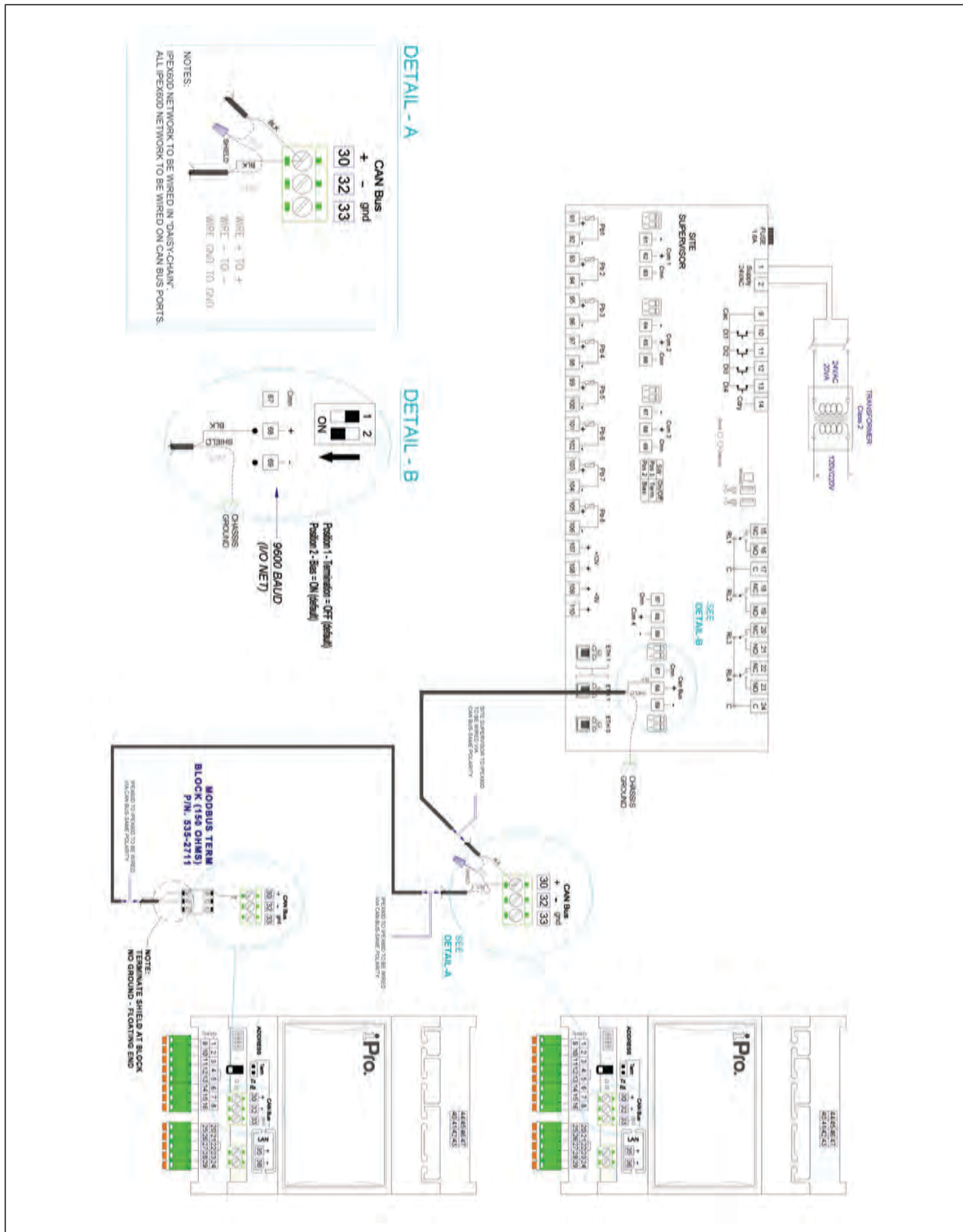

Figure 3-28 - Supervisory Controller and 10.1-Inch Display



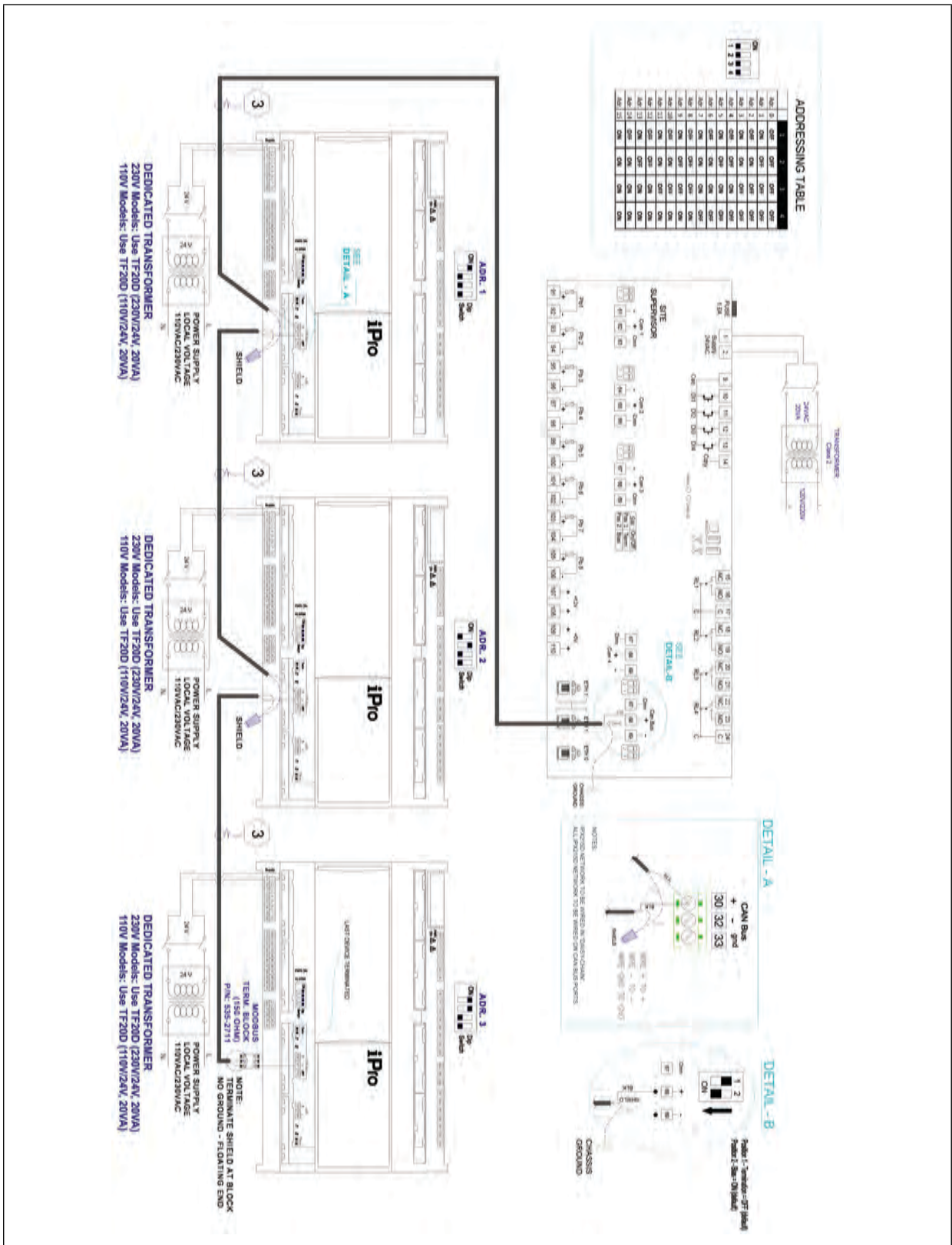

Figure 3-30 - Supervisory Controller and iPro-G Wiring

4 Supervisory Controller Basic Navigation

Log into Supervisory Controller by clicking the Login icon in the upper right part of the screen. For the Main Menu, click the gear icon and the panel will slide open. Click the gear icon again or to the right of the panel to close.

Six icons at the first row along the top of the screen are the Back Arrow, Main Menu, Home, Refresh, Control Inventory, and Schedule and Events. Refer to **(Table 4-1)** for icon descriptions.

4.1 Menus and Submenus

1. **Login** - Logs you into the Supervisory controller. Click and enter your username and password. Once logged in, clicking Logout will log you back out of the system. (You will automatically be logged out of the system after a specified period of idle time.)
*Enter your Username/Password (default user/pass) and click **Login**. Then update your password to the minimum complexity requirements and click **Save**.*
2. **Home** - Returns you to the set Home screen. Click the Home icon to return to the Home screen from anywhere in the system.
3. **Summaries** - Three submenus will display: Case Defrost Schedule Summary, Network Summary, and System Summary. Click each selection or drop-down arrow (caret) to expand. Note that if Peer Network is set up, the area controllers will display under the Summaries menu under Area Controllers.
 - **Case Defrost Schedule Summary** - Takes you to the Case Defrost Schedule Summary page where edits to case defrost schedules can be managed.
 - **Network Summary** - The network summary shows the status of all network devices associated with this Site Supervisor.
 - **Online** - The device is online and communicating normally.
 - **Offline** - The device is not communicating (dropped off the network, has not been commissioned, is not functional, or is not powered up).
 - **Unknown** - Unable to communicate with the device.
 - **This Supvr** - Represents the current Supervisory controller you are using; therefore, only one entry in the list can show this status.
 - **System Summary** - Returns you to the home screen.
4. **System Logs & Statistics** - Contains controller system information for technical personnel-level users. Setpoint files can now be printed. Select **Setpoint Report**. This report can be downloaded, saved, or printed. Select **Service Log for Clean Out and Reset** buttons. **Clean Out** will return the controller to factory defaults. The controller will reboot after a clean out with all programmed applications, logs, and other data erased. *CAUTION: A clean out will erase all programmed parameters from memory.* The **Reset** button only restarts and reboots the controller.
5. **Configure System** - Contains navigation to Logging Groups, Alarm Communications, File Management & Licensing, General System Properties, Manage Users (performs account creation and role assignment for system users, view, edit, and remove users) and My Profile (allows you to create or edit your personal profile page, create keyboard shortcuts, set localization and engineering unit settings and more). Click the drop-down arrow (caret) to expand.
 - **Logging Groups** - Allows you to view log parameters, add new logging groups, edit parameters of existing logging groups, and delete logging groups.
 - **Alarm Communications** - View, edit, or delete alarm notices from this page. Enable All to view all notices in the system.

- **File Management & Licensing** - File Management opens the File Management screen where you can view ADF part number, install and delete application description (ADF) files, backup and restore system configuration, install and delete floor plans, add/delete a license, view application licenses in the system, add a Feature Set, and upgrade firmware.
 - **General System Properties** - Contains a drop-down menu that includes these submenus: COM Ports (COM Ports and baud rate settings), Network Settings (Internet, subnet mask, DNS, MAC Address, Email (SMTP), Text messaging (SMS) and more), Localization (language and engineering unit settings), and System Values (general setup parameters, Web server and UI setup).
6. **Advanced** - This menu is visible when a user's profile menu is set to Basic. If the user profile menu is set to Advanced, the button will not be visible. To configure, go to the gear icon > **Configure System** > **My Profile** > **Select User View Level** > choose **Basic** or **Advanced**.

4.2 COM Port Bandwidth Color Scheme

General Changes Color Scheme Help Description:

| Color | Description |
|--------|--|
| Green | Lite Network Load - The connection is operating smoothly with no delays in data transmission. |
| Yellow | Marginal Network Load - The connection is moderately busy with no noticeable delays in data transmission. |
| Orange | High Network Load - The connection is highly utilized and data transmission may be slower than usual. |

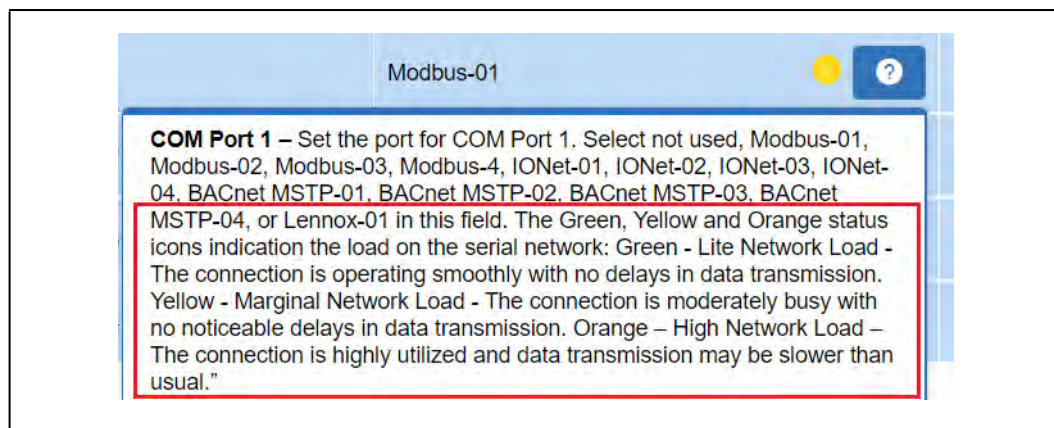
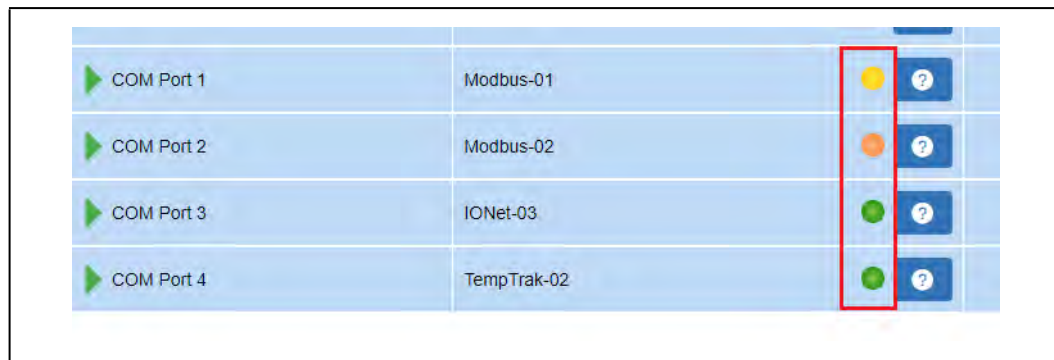

4.3 COM Port Bandwidth Calculator

The COM port Bandwidth Calculator is used to determine if more controllers are added to a port than can be supported theoretically when controller communications are stable. The Modbus Com Stat Report shows which port is receiving the most data.

The COM Port Bandwidth Calculator shows the bandwidth loading on all available Modbus COM ports. For each port, the calculator evaluates the devices currently assigned to the port to determine how much of the available communication bandwidth has been consumed by the defined devices. The result is shown as a color indicator.

Previous bandwidth calculators specified a maximum number of devices recommended to be commissioned on a COM port, using an external spreadsheet tool. E3 simplifies this determination using a real-time color coding displayed next to each COM port. The color is updated each time a new device is added to the port.

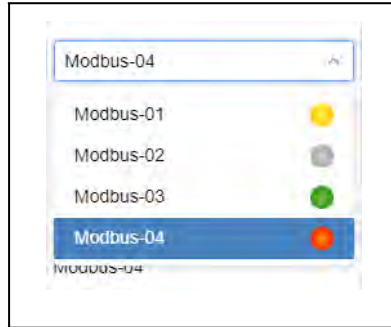

Figure 4-1 - Com Ports 1 to 4

As more and more devices are added to a communication port, the available bandwidth of that port will decrease. Eventually, if enough devices are added, there will be no remaining bandwidth which could result in slower data transfer between the devices and the supervisory controller.

Some Modbus devices require more communication bandwidth than others, depending on the functionality of the device. The bandwidth calculator can determine the relative bandwidth load for any devices that support the bandwidth calculator.

As devices are added to a communication port, the calculator will indicate if the maximum load is being reached for that port.

| Condition | Notes/Warning | Color Code |
|-----------|--|------------|
| Good | An optimum number of devices is on the port and there are no bandwidth restrictions. | Green |
| Notice | Bandwidth usage has now reached a high limit. There will be a notification immediately during commissioning if there is a bandwidth issue and an indication that devices may need to be shifted to another port. | Yellow |
| Alert | Approaching the maximum limit of devices on the port. The number of controllers has exceeded the available bandwidth for this route. | Red |

The COM port Bandwidth Calculator is now integrated into Control Inventory page. In the drop-down list of the Port ID column, a color indicator has been added for the bandwidth condition:

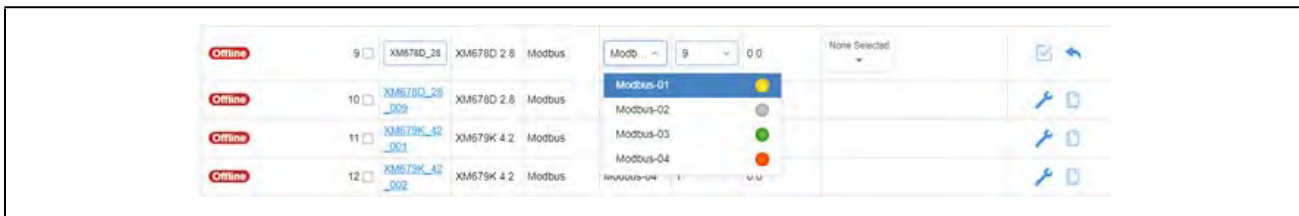

Figure 4-2 - Control Inventory Page COM Port Calculator

The COM Port Bandwidth Calculator is also available on the **General System Settings COM Ports** page.

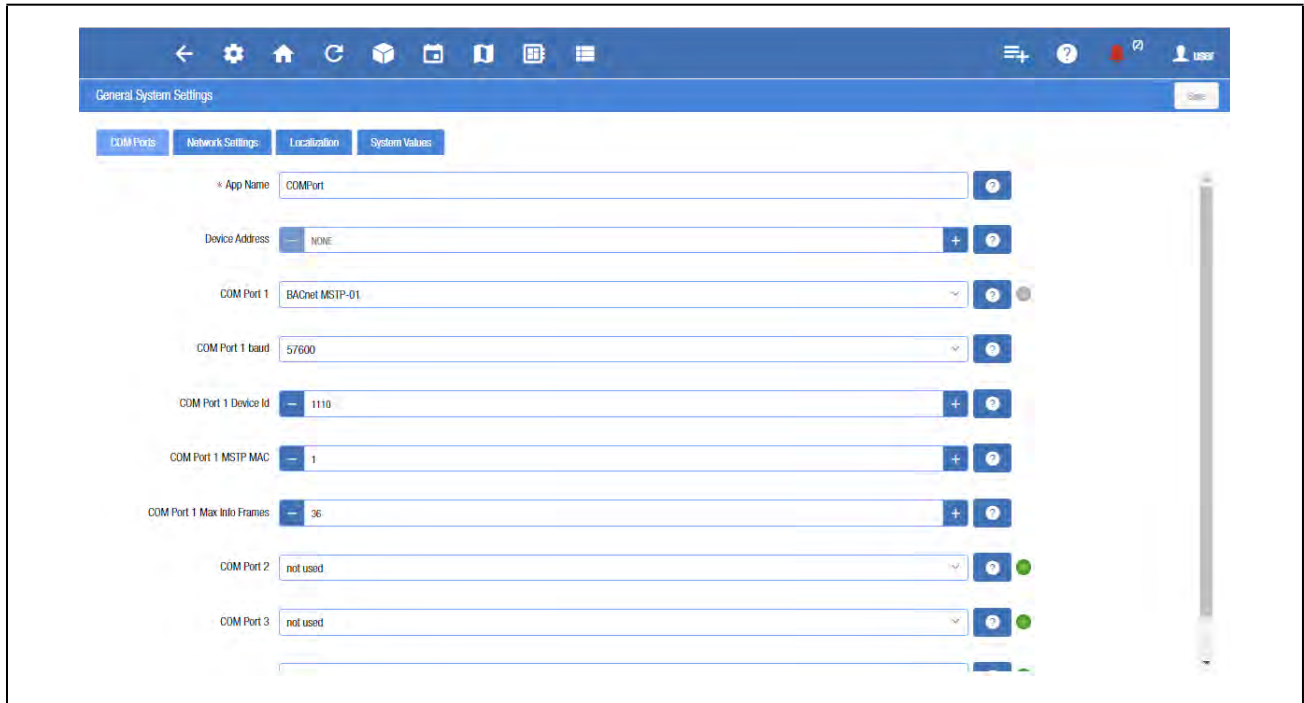

Figure 4-3 - General System Properties COM Port Settings Page

4.4 Overview

4.4.1 Conditional Visibility

Conditional Visibility allows points to be viewed that are applicable to the defined view level (Basic or Advanced - equivalent to "Full Options" in previous generation controllers) for certain (not all) applications.

NOTE: The mobile Supervisory Controller view does not support conditional visibility.

4.4.1.1 User View Details

NOTE: When you navigate to a specified screen, you will see the points equal to or less than your View Level available on the Supervisory Controller's rule. The basic user level does not see the Advanced view level point.

Some screen information and contents are editable, which when clicked can either display additional or related information or move to another screen.

NOTE: The screen will only display applicable points according to your view level and the Supervisory Controller's rules.

4.5 Basic Screen Elements









| Icons | Functions |
|---|--|
| | <p>Main display - This is the main section of the screen, which contains and displays the content of the chosen selection such as reports, device information, configuration settings, and more.</p> |
|  | <p>Main Menu (gear) - When clicked, the Main Menu panel will slide open containing the menus and submenus of the controller.</p> |
|  | <p>Home button - Returns you to the default Home screen of the controller.</p> |
|  | <p>Back button - This button will return you to the previous screen. The Back button is indicated by a left arrow icon.</p> |
|  | <p>Active Alarms (red circle with exclamation mark) - When this icon is clicked, the screen will display the current active alarms. The number of alarms is displayed in parentheses next to the exclamation mark.</p> |
|  | <p>Control Inventory (box) - Select this box to access the Control Inventory screen where applications can be managed.</p> |
|  | <p>Time Schedules (calendar) - Select to access the Schedules and Events screen where Schedules, Events, Inputs/Outputs, Alarms, and System information is located.</p> |
|  | <p>Refresh - Select to return to the Home screen and log out.</p> |
|  | <p>Application Icon - Click to choose an application from the list and add to the controller. Once added, you will be taken directly to that application screen in the controller.</p> |
|  | <p>Send To</p> <ul style="list-style-type: none"> Changes to multiple applications at the same time using the Send To button. Changes to summary parameters, setpoints, log points, and other parameters can now be sent to multiple, user-selected "like" applications. A single change or multiple changes can be sent to all "like" applications using the Save and Send To buttons, eliminating making a change individually to each application one at a time. For example, updates to a temperature setpoint can be sent with a single click to all controllers that you wish to update. The save confirmation will confirm all changes made. Source points can be sent to target users. Tile point changes to an application can be sent selectively to other applications of the same type. Tile point displays can be easily created for specific application and users. |

Table 4-1 - Basic Screen Icons

4.6 Language Settings

The default for the language selection is English (United States). The system will store a setting for the preferred system language (internal language code). This is used when no authorized user is logged in. The default language is used as a fall back when the currently active preferred language doesn't contain a translation for the given label, prompt, or display text.

To change the language setting:

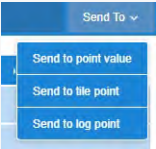
1. Log into the Site Supervisor.



Figure 4-4 - Logging In

2. Click the **Main Menu** icon.
3. Click **Configure System > General System Settings**.



Figure 4-5 - Language Settings Set Up

4. On the **General System Settings** page, click the Localization tab.
5. Choose the preferred language on the Language drop-down menu.
6. Click the **Save** button.



NOTE: English is the only language available. Changing this setting will only change the engineering units appropriate to the region selected.

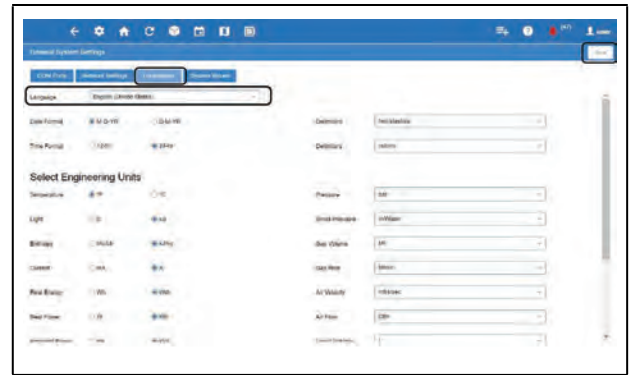

Figure 4-6 - Language Settings Set Up

7. The Confirmation pop-up box will appear on the screen showing the summary of changes, click **OK** or **Cancel** button.

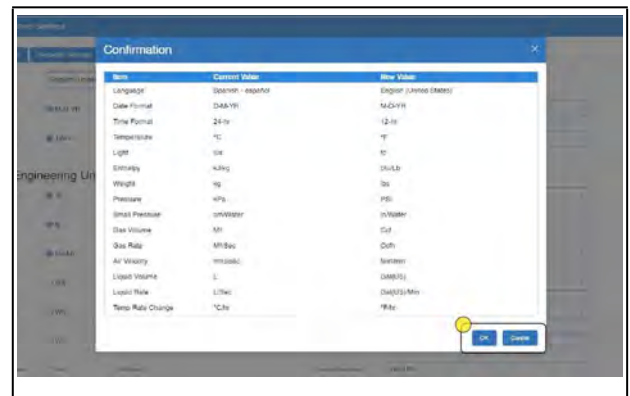

Figure 4-7 - Language Settings Set Up

4.7 Locating and Working With Applications

Applications in the controller are located on the Home screen and from individual application screens and are easy to find.

Each of the five categories can be seen on the Home screen and if applications have been set up, they will display under the category to which they have been assigned. For example, in **Figure 4-8** all of the five categories are displayed with Refrigeration containing two applications that have been set up. Choose an application and the categories will then be displayed as icons across the top that are easily accessible. Click the icons to see the applications.

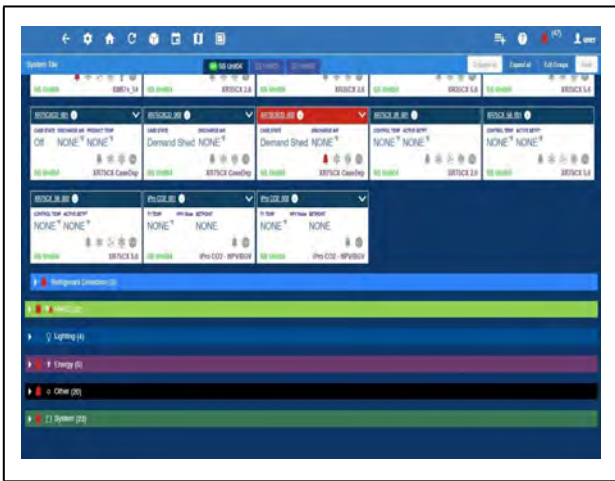

Figure 4-8 - Home Screen Application Menus

The five categories are displayed on each application screen. Click each icon to view applications that have been set up for each category. For example, in **Figure 4-9**, the Refrigeration icon has been clicked and the applications for that category are displayed (Standard Circuits and XR75CX). Click the application to go directly to that screen.

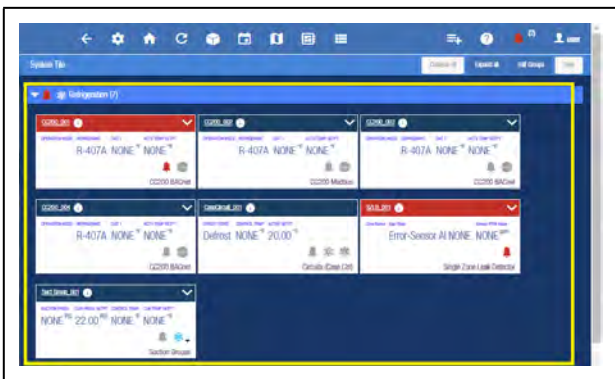

Figure 4-9 - Application Screen Menus

4.8 Application Tabs

4.8.1 Performance Meter

Performance Meter gives the user a quick and simple visual indication of system performance and early insight that provides an opportunity to take corrective actions to remedy conditions that may be reducing energy efficiency, causing required service or ultimately leading to costly failures. Performance Meter is a licensed application that looks at the operational performance in relation to a desired setpoint and calculates a “Figure of Merit” (FOM), which takes into account deviations above and below setpoints, but excluding defrosts. The overall FOM value uses both high-temperature conditions that result in product degradation as well as low-temperature conditions, which is an energy penalty and most often goes undetected. Performance Meter gives the user a graphical representation of performance data that shows instances for performance that fall outside of the expected normal performance band.

The Performance Meter tab will only be visible if licensed. To display this tab, the user must click the **Advanced** button, then click three-line menu as shown in **Figure 4-10**, then click Performance.

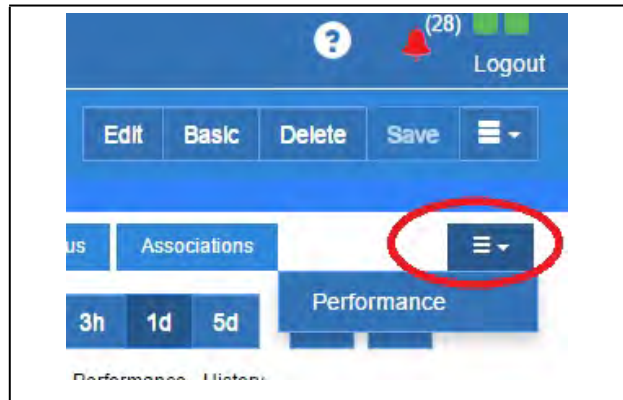

Figure 4-10 - Performance Meter Tab

4.8.2 Site Aggregation

Site Aggregation brings together status and data from multiple controllers into one convenient view. You can drag and drop the summary information into the order that is most important to you. This can be your preferred view when you log in with your user name. You can also create custom categories, and drag and drop Summary Tiles into categories and in the order you prefer. Categories appear collapsed by default on the System Summary screen. (This feature is supported by all models and not limited to having a Site Aggregator license.)

To create a new custom category, click **Edit Groups** on the upper-right corner of the screen, then click the plus sign that appears opposite the application name. An open box (Category Name) will appear. Enter the name of your custom category and click **Save**.

The Site Aggregator floor plan now links to E2 peer application status and overrides. The Site Aggregator can now be used with an E2 peer network to render E2 status and overrides on floor plan.

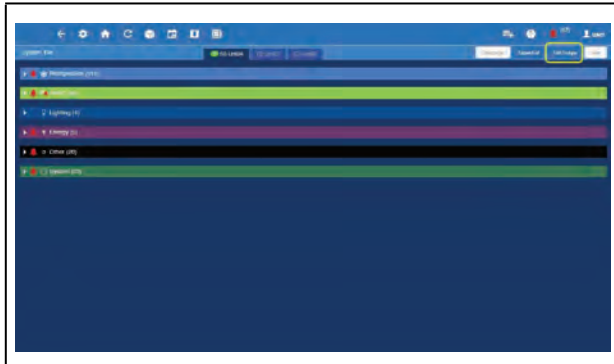

Figure 4-11 - Click Edit

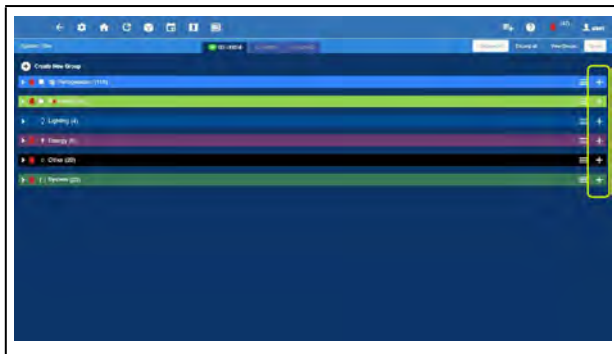

Figure 4-12 - Click the Plus Sign



Figure 4-13 - Enter Category Name

4.8.3 Control Inventory

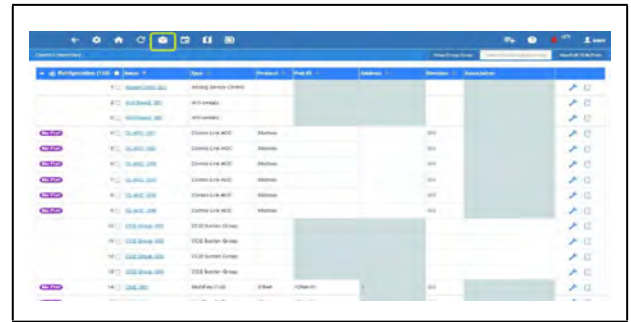

Figure 4-14 - Control Inventory Page

Control Inventory provides a centralized control list by category. It allows you to view the network status of controls, and perform the following functions: create and duplicate one or more controls to a group quickly, commission a device, associate controls to other controls, edit the control name or commission information for existing controls, and delete a control from existing groups.

To duplicate an application, the appropriate user privileges must be assigned. The user can specify the number of duplicated instances for a device or application. When a device or application is duplicated, the points specified by the user or application type on the status tiles is also duplicated. The name of each duplicated instance is unique. The maximum total number of application instances of a given type, including duplicated instances of that type, will not exceed the license limit for that type.



Once the user has logged in, click the duplicate button next to the application on the screen. Select the count in **Number of Duplicates**.

4.8.3.1 Adding Applications

1. Add an application to your Supervisor by first going to the Control Inventory page.
2. After logging in, click the **Control Inventory** icon at the top of the screen.
3. From the Control Inventory screen, select an application to add from the drop-down list at the bottom of each category.
4. Fill in the fields and click **Save**.
5. Go back to the Home screen to verify the application appears under the category.

4.9 ADFs

An ADF is an Application Description File. ADFs allow a particular device to communicate on the Supervisor. An ADF is required before connecting a non-native device on the Supervisor. The ADF is not automatically activated on the Supervisor after installation. A license key is required to enable specified instances of the application/device. Contact your Sales representative or Customer Service to obtain an ADF. The ADF can be uploaded on the Supervisor using the File Management screen. A license key is required to active the application after the ADF has been uploaded. A license key can be obtained from Technical Support with necessary approval. Email ColdChain.TechnicalServices@Copeland.com with the below information to generate the required license:

1. Name of the application/device
2. Supervisor MAC address and Model Type
3. Number of instance of the application

4.10 Creating a Backup and Restore

4.10.1 Backup

Creating a backup is important if you are planning to upgrade the Supervisor firmware. A Backup file does not save properties such as Ethernet settings, loaded license keys, firmware versions, alarm history, and logs.

1. Log into the Supervisor.

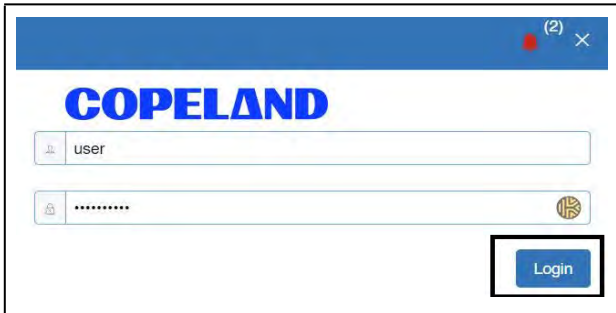

Figure 4-15 - Logging In

2. From the home page, click the gear icon and choose **System > File Management & Licensing**.

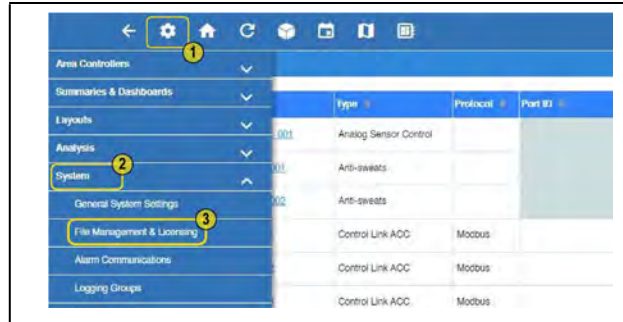

Figure 4-16 - File Management & Licensing

3. Click **Backup** and select where to save the Backup (Local PC or Other Devices; SD Card) and enter a name for the Backup.

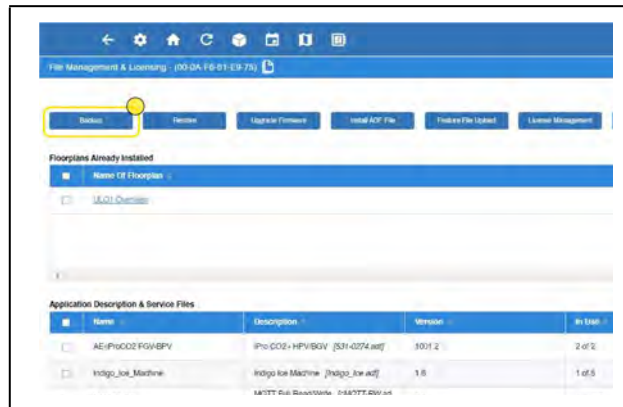

Figure 4-17 - Click Backup

4. Click **Backup** to save. The Backup file location will appear at the bottom of your browser.

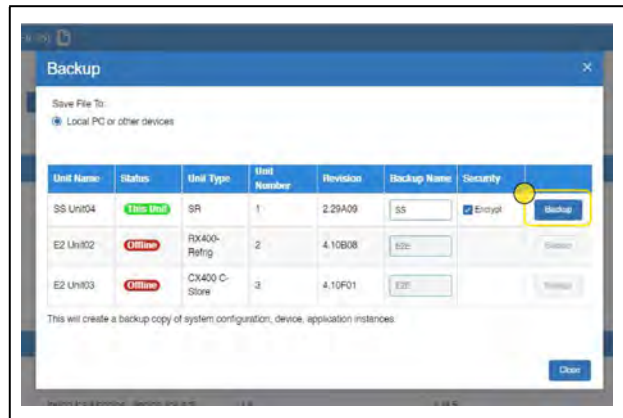

Figure 4-18 - Backup File Location

4.10.2 Encrypted Backup

Added the option to encrypt backups to enhance security.

Note: You must have at least 2.26F01 in order to restore an encrypted backup file.

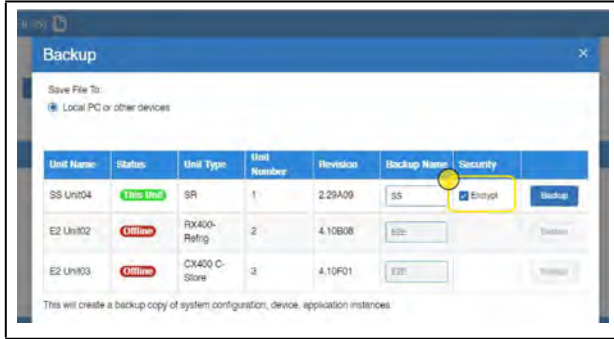

Figure 4-19 - Encrypting Backup

If you plan to install on a previous version, uncheck the Encrypt box before performing the backup.

4.10.3 Restore

If the Backup file is available, a Restoration can be performed. To successfully Restore, the Supervisor used to create the Backup and the Supervisor to be restored should be the same model. The ADF and license keys must be complete on the Supervisor to be restored, matching the applications configured on the Backup file.

1. From the home page, click the gear icon and choose **Configure Settings > File Management & Licensing**.

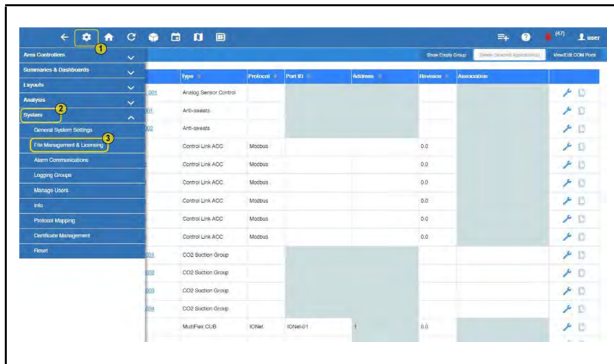

Figure 4-20 - File Management & Licensing

2. Click **Restore**.

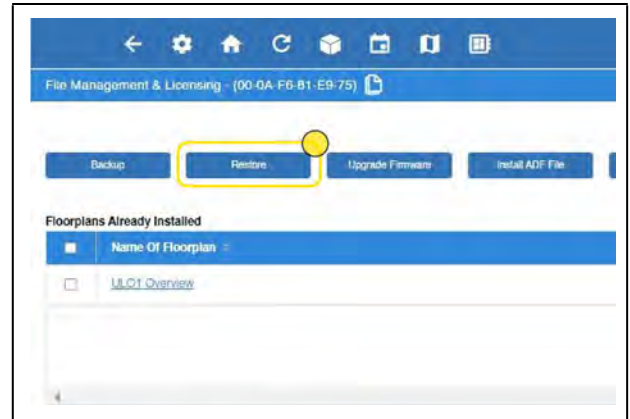

Figure 4-21 - Restore

3. Select the source of the Backup file. Click **Select**.
4. Select the Backup file from its location.
5. Click **Open**.
6. Click **Restore**.

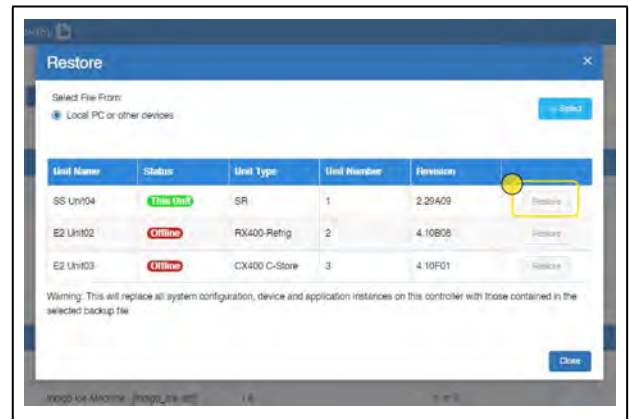

Figure 4-22 - Restore

7. Click **OK** or **Cancel** on the confirmation window.

The Site Supervisor provides a restore notice when restoring backup files. The notice will list any applications that did not restore and the reason why, such as number application limits exceeded, or missing ADF files.

4.11 Using the Help Menu

This section contains instructions for using the help menu on the Site Supervisor.

1. Log into the Site Supervisor and enter the username and password.



Figure 4-23 - Logging In to the Supervisory Controller

2. From anywhere in the controller, click the Help icon (question mark inside a circle).
3. A search field is available at the top of each help page. Enter a keyword into the search field and the help page you are currently viewing will be searched for the keyword.

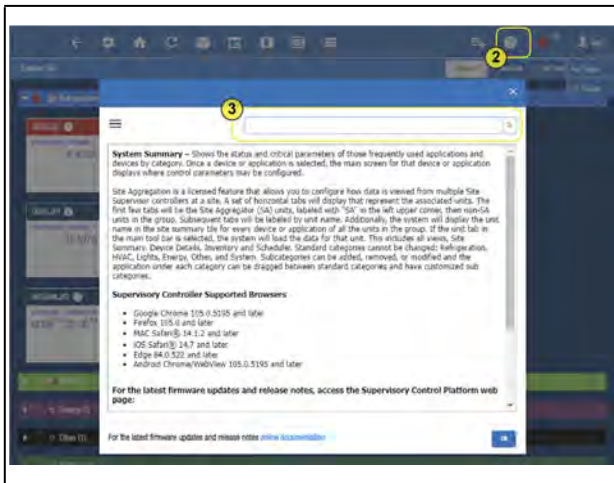

Figure 4-24 - Click Help Icon for Page Help

4. Click the **Main Menu** button (three horizontal lines) to show the complete menu. It will provide links to the complete help menu with links per topic on the table of contents.
5. Search key words on the search box to narrow down topics to search.

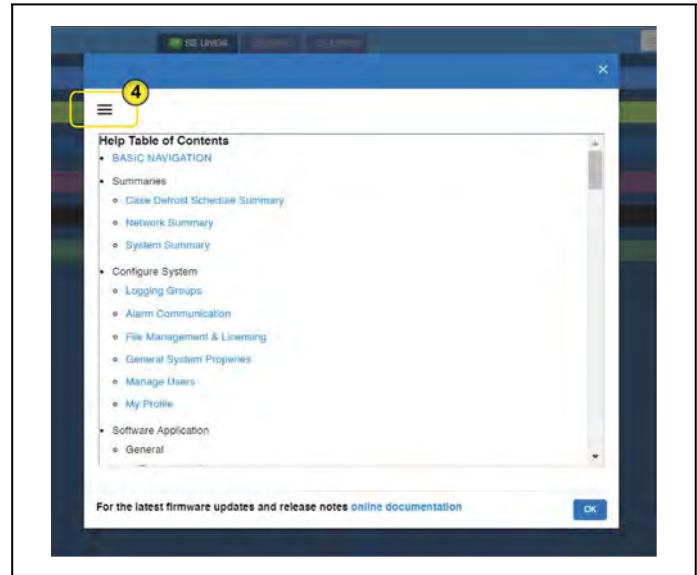

Figure 4-25 - Click Help Icon for Page Help



NOTE: The HELP menu is context sensitive and will display information about the function, application, or device the user is viewing.

4.12 Icons or Buttons Appearing on the Home Screen

| | Icon | Function |
|---|-----------------------|--|
|  | Main Menu Gear Icon | Found at the top left-hand side of the page. When the main menu gear icon is clicked, the main menu panel will slide open containing the menus and submenus of the controller. |
|  | Home | Opens the main menu panel when clicked. The main menu panel contains menus and submenus of the controller. |
|  | Back Arrow | The Back button will return you to the previous screen. |
|  | Active Alarms | When the Active Alarm icon is clicked, the screen will display the current active alarms. |
|  | Filter | Clicking the Filter icon opens the Filter Alarms screen which allows you to choose or filter the type of alarm you want to see on your Active Alarms screen. |
|  | Control Inventory | Click to manage the system-wide inventory of applications. Edit, delete, and add applications from this screen. |
|  | Time Schedules | Click to add and edit schedules and events. |
|  | Floor Plan | Displays the Floor Plan screen where you can select and work with floor plans. |
|  | Physical I/O Status | Displays a system-wide report of all inputs and outputs for all Applications in the controller. |
|  | Add Application | Click to choose an application from the list and add to the controller. Once added, you will be taken directly to that application screen in the controller. |
|  | Screen Drop-down Menu | The screen drop-down menu is activated when the current screen is active/online. This menu contains other options such as Download, E-mail, Print, and View History. |
|  | Refrigeration | Displays on Home screen and application screens. Shows all applications in the controller that are categorized under Refrigeration. |

Table 4-2 - Top Screen Icons and Buttons





| | Icon | Function |
|---|----------|--|
|  | HVAC | Displays on Home screen and application screens. Shows all applications in the controller that are categorized under HVAC. |
|  | Lighting | Displays on Home screen and application screens. Shows all applications in the controller that are categorized under Lighting. |
|  | Energy | Displays on Home screen and application screens. Shows all applications in the controller that are categorized under Energy. |
|  | Other | Displays on Home screen and application screens. Shows all applications in the controller that are categorized under Other. |
|  | System | Displays on Home screen and application screens. Shows all applications in the controller that are categorized under System. |

Table 4-2 - Top Screen Icons and Buttons

5 Logging Groups

A logging group is a set of application property inputs and outputs whose value are recorded (logged) with the same parameters. Parameters include the interval, how often the property values are logged (for example, every 30 seconds, every 5 minutes, etc.), the duration of the log (for example, 2 days, 30 days, 100 days, etc.), and the resolutions (how precisely the analog values are recorded). Individual logging groups can be configured to archive data to an SD card if desired.

5.1 Supported Functions

1. Viewing log parameters.
2. Adding new logging groups.
3. Editing parameters of existing logging groups.
4. Deleting logging groups.

Select **View & Edit** to view, edit, or delete logging groups.

The Points List appears on the right-hand side of the screen showing all the points logged in the system.

5.2 Data Logging Types

The system handles the following types of data logging:

Base Log - Takes the measurements from all data points associated with the log group at a fixed frequency over a defined period of time. The measurements are time-bound stored in an internal non-volatile memory. The system will support a maximum of 1000 digital points or 750 analog points to be logged at a 15 minute interval for a maximum of 365 days.

Utility Log - Takes the measurements from all data points associated with the utility logging group at a frequency defined by the application to which each data point belongs. A logging group configured as Utility can contain multiple points logged at different intervals. Applications which contain data points supporting utility logging are Global Data (Heating/Cooling/Enthalpy degree-day outputs) and Utility Monitoring (all totalizer outputs). All of these data points are automatically associated with the Util Base Log default logging group.

5.3 Logging Group Functions

Create New Group

Create logging groups and configure settings for logging groups. On this screen, the user can view, edit, and delete logging groups.

Name

The name assigned to this instance of a log group.

Mode

The logging mode is one of the following: Continuous or Utility.

- **Continuous Mode** - Logs occur at regular intervals determined by the Log Interval.
- **Utility Mode** - Allows individual applications (device representations or other) to log (save) samples at arbitrary (non-periodic) time stamps. This is used by applications that need to be in control when exactly a sample is written and the value is cleared, reset or other action taken. (The default setting is **Continuous**.)

Log Interval

The rate (every 15 seconds) or amount of time between log samples or measurement. The user configurable range for this property is 15 seconds to 12 hours in 5 second increments. The default setting is **00:03:00 (3 minutes)**.

Log Duration

Specifies the number of whole days of logging that is kept for each point associated with this logging group. The default setting is **14 days**.

Log Total Samples

This parameter is only available for logging groups configured as Utility. It specifies the maximum number of measurement samples for the utility logging group to store in memory. Once the maximum number of samples has been logged, each new sample will overwrite the oldest sample in the log.

Default Log Group

Enable the checkbox for default logging group information. Indicates this log group to be the default (or base) log group for the system. This indicates that this is the log group used when new applications are added that have properties defined to be automatically logged (default logging).

Note: There must be only 1 log group defined in the system with this property enabled. If all available logging space is reserved, any new applications added that contain default logging will have their default logging configurations disabled. An entry is placed in the systems service log indicating this modification including the specific application name and point.

Enable

Drop-down menu options: ON, OFF, and NONE. The enable input enables or disables logging within this logging group. When the value of this input is On, logging is active; when the input is set to Off, logging for this log group is suspended. The default value is **On**.

Archive Enable

Enable the checkbox to see archive logging information.

Archive Notice Present

The available storage threshold percentage for the location of the archive destination used if Archive Enabled is activated. The default setting is **80%**. When an archive is performed and the amount of used storage is or above 80%, a notice is generated. If the Archive Notice is set to 0% the generation of a NOTICE is disabled.

Archive Destination

This property holds the location of the archive destination used if Archive Enable is enabled.

Arc Per Alm Dly

Enter the archive delay for each alarm delay (HH:MM:SS).

Archive Percentage Full

Set the archive severity for each alarm type (Notice, Non-Critical, or Critical).

Category

Set the archive category where each alarm should belong (System, Refrigeration, HVAC, Lighting, Energy, Other.)

Display Message

Enter the display message that will appear with each alarm describing the problem.

Repeat Rate

Set the rate at which each alarm will repeat (HH:MM).

Monitor Alarm

Set this to ON or OFF to choose whether alarms will be monitored.

Log Data Export

The system let the user to export any selected log data as a CSV formatted file. Exported data can be saved to an attached USB device, outbound FTP to a predefined server, emailed or saved to user's local drive via browser interface.

Log Data Archive

The system archive log data to the SD card if installed. The system allows the user to specify the destination of the archive per log group basis. If configured and the SD card is subsequently removed or the Archive Notice percentage is full, a NOTICE advisory is generated and log data archiving is disabled.

The system archive log data to an FTP site. The system allows the user to specify the destination of the archive per log group basis. If configured and the FTP site is subsequently unavailable or the transmission is refused because of credential failure or due to a configuration issue, a NOTICE advisory will be generated and log data archiving will be suspended (Log Archive disabled).

Log Group Point Assignment

The system lets the user to assign a single input to multiple log groups. This allows the user to temporarily assign a point to a fast log group while maintaining logging integrity with the base log group or other assigned log group.

Runtime Logging

The system provides a facility to the user to produce and track cumulative runtime calculations and counts on analog and digital points. These cumulative results are handled outside the normal data interval logging facility (i.e., an application) but can be logged using the data logging facility. Runtime logs are written to flash for preserving over a reboot every 10 minutes.

The following run time logs are available to the user:

| | |
|-----------------------|--|
| Analog Points | Average since reset command issued |
| | Minimum value since reset command issued |
| | Minimum value today |
| | Minimum value yesterday |
| | Maximum value since reset command issued |
| | Maximum value today |
| Digital Points | Maximum value yesterday |
| | Cycle counts since reset command issued |
| | Cycle counts today |
| | Cycle counts yesterday |
| | Runtime since reset command issued |
| | Runtime today |
| | Runtime yesterday |

Note: Reset Input - is used to trigger a reset on the runtime data.

Runtime Logging Definition

The definition of outputs that have runtime logging enabled is determined and defined at the creation of the application description file. By default, not all outputs of an application are enabled for runtime logging.

Application Data Logging

The system provides individual or value-add applications the ability to log application specific data. The system allows the remote clients to retrieve these logs.

6 Alarm Configuration

Alarms in the supervisory controller can be generated from different sources including external networked devices, applications, value-added applications, and sub-systems. Alarm configuration, transmission, and history settings can be defined by the user.

1. Log in to the Site Supervisor by clicking **Login** on the Main Menu, located on upper right side of the screen and enter your username/password.

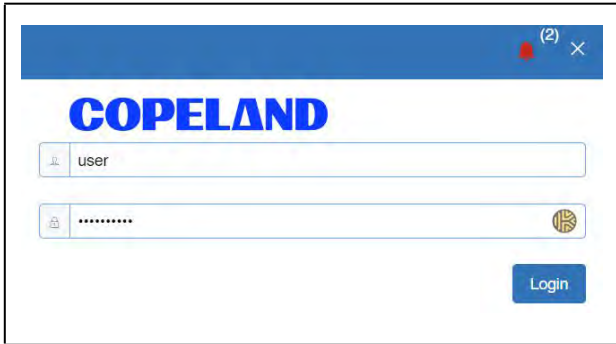

Figure 6-1 - Site Supervisor Login

2. From the Home screen, navigate to **Summaries & Dashboards > System Tile**.

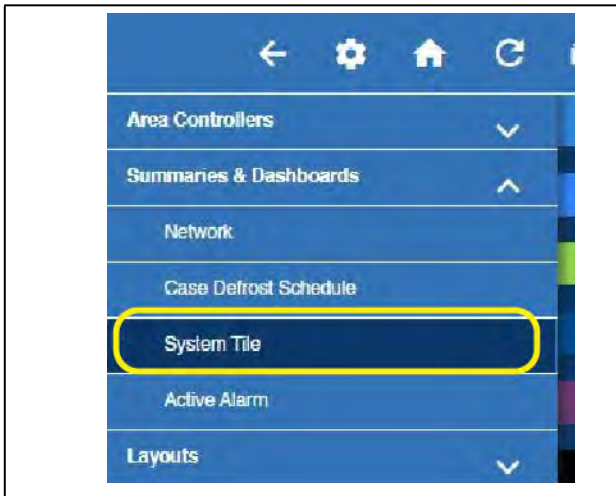

Figure 6-2 - Accessing Site Summary

3. In this example, alarm configuration for XR75CX 5.6 controller is used. Select the XR75CX 5.6 device on the Site Summary screen to access the device status page.

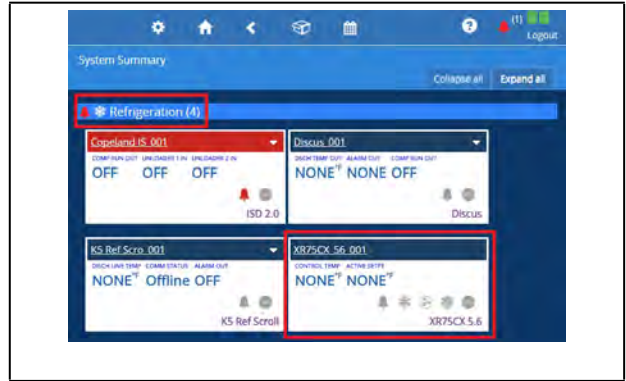

Figure 6-3 - XR75CX Under Refrigeration

4. On the drop-down menu on the upper right of the screen, click **Edit** and **Advanced** to access configuration properties and alarms for the XR75CX 5.6 device.

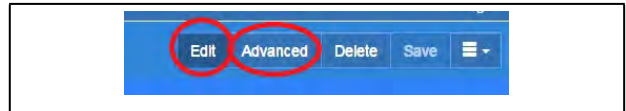

Figure 6-4 - Accessing the Configuration Properties of XR75CX 5.6

5. Click each tab to see the XR75CX parameters:

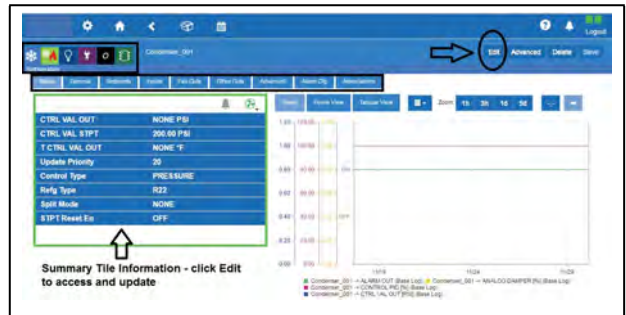

Figure 6-5 - XR75CX 5.6 Tabs

In the Status tab, selecting properties for the Status tab list is unlimited. The top 10 properties shown on the System Summary tile will appear with a different color from the rest of the items on the list. Properties can be dragged and dropped into the list and color designations can be changed. **Note that under the Status tab on any device application page, the wrench icon can be clicked for customizing the summary tile information.**

Users who are logged in with System Administrator privileges can overwrite the default setting on the selected point's section that will be synchronized with the tiles on the System Summary page. New category icons are located across the top and when clicked will go to those application pages.

6.1 Alarm Configuration

- For alarm configurations, scroll down to the **Alarm Cfg parameter** section.

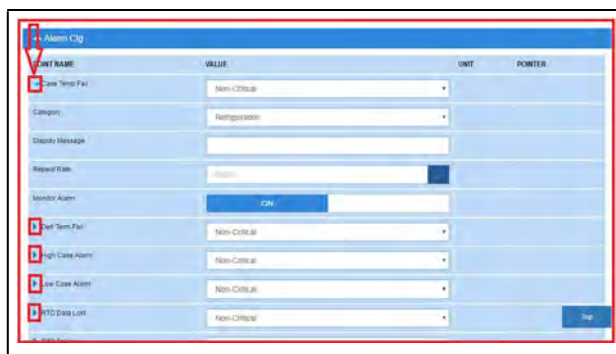

Figure 6-6 - Configuring Alarms

- On the **Alarm Cfg parameter** section, click the arrow beside the name of the parameter to configure other settings for alarming.
 - Alarm descriptions can be overridden from this page. Enter the name of each application alarm you wish to appear in the alarm log. If no name has been entered, the default alarm message will display in the alarm log.
 - Each alarm type (urgency level) can be categorized as Non-Critical, Critical, or Notice (the least urgent).
 - Each alarm category (where it is categorized in the supervisory controller) can be set under the Category field: Refrigeration, HVAC, Lighting, Energy, or Other.
 - Set the repeat time for the alarm on the **Repeat Rate** field, which is the time the advisory is next scheduled to repeat if not acknowledged. A repeated advisory will re-queue to the system as if it had just been generated. However, it will not create a new instance; it will only update the existing instance with the next repeat time. All other processing and propagation will act as a new instance of an advisory.
 - Set the **Monitor Alarm** field to **ON** (if the alarm will go to the call center for monitoring) or **OFF** (for no call center monitoring).
- Once configurations have been set, select **Save** on the upper right side of the screen.

6.2 Alarm Communications

To enable and disable alarms, go to the specific alarm application.

Use Alarm Communications for sending a person or group of people alarm notifications per category instead of by specific application alarms. To enable and disable alarms, go to the specific alarm application.

Alarms in the supervisory controller can be generated from different sources including external networked devices, applications, value-added applications, and subsystems. Alarm configuration, transmission, and history settings can be defined by the user. From here, schedule alarm communications to specific users during specific times. For example, if you would like to get alarms for the Refrigeration category, Mon-Fri from 8pm to 5am, this is where the setup would take place, and not the times when alarms are "active." Schedules are set up in Time Schedules.

Step 1: Verify you have a Schedule set up in Time Schedules. This will be the schedule you associate in the Schedule tab and use to schedule the alarm communications.

Step 2: To begin, click the plus sign + to Add an Alarm Notice. Click **Edit** in the top right corner to change the name if desired.

Step 3: Set up your alarm communication parameters using the tabs.

- Choose the Category of all the alarms being communicated. Set one category to ON and to others to OFF.
- Next, choose the Alarm Type of all the alarms being communicated. Set one to ON and others to OFF.
- Now choose the Resolution type for all the alarms being communicated. Set one to ON and others to OFF.
- And select the Schedule to be communicated. This will be displayed in the Associations tab.
- Set the Recipients of the alarm information by clicking the plus sign by RECIPIENTS+ and enter the information in the window. Click **Save**. Click **Edit** in the upper right to edit information already on the page.
- Under Settings, choose **Email** or **SMS** for the communication method.

6.2.1 Alarm Communications Setting

Configure alarm communications setting on Alarm Communications screen for SMTP (emailing), and texting alarms.

From the Home screen, navigate to **Main Menu > System > Alarm Communications** and click **Add an Alarm Notice** at the top.

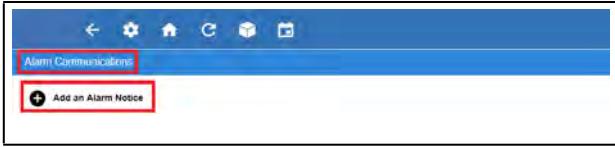

Figure 6-7 - Alarm Comm Page - Create New Alarm Notice

The Alarm Communications screen creates a custom notification of alarm conditions or set default values for as many as 20 notifications for each device.

NOTE: This screen will not be accessible if you are not logged into the controller.

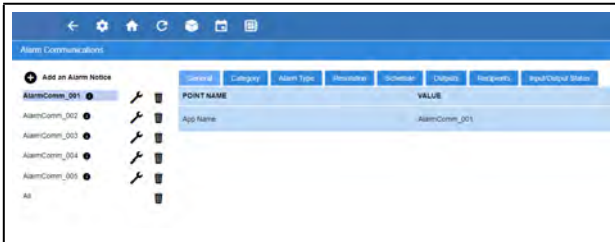



Figure 6-8 - Alarm Communications Tabs

When creating a new alarm notice, there are three steps on the Alarm Communications page:

Step 1: Enter a unique name

- Click the wrench icon  beside the alarm notice to view the tabs then click **Edit** located on the upper right side of the screen. Name the alarm notice by entering a unique identifier under **App Name** in the **General** tab.

Step 2: Select all of the desired options under each tab

- Category** - Select ON or OFF for the following category menu options: Refrigeration, HVAC, Lighting, Energy, Other, System, and ProAct.
- Alarm type** - Select ON or OFF for the following alarm-type menu options: Critical, Non-Critical, and Notice (least urgent).
- Resolution** - Select how the alarm notice should be handled. Select ON or OFF for the following

resolution menu options: Acknowledge, Reset to Normal, and Return to Normal.

- Schedule** - Select an option from the drop-down list.
- Outputs** - The output menu options are the following: Alarm Out 1 Config (Audio), Alarm Out 2 Config (Visual), Alarm Out 3 Config (3rd Party A), and Alarm Out 4 Config (3rd Party B). Select the desired value for each output menu option: Not enabled, Active until acknowledged, Active until muted, or Timed one-shot pulse.

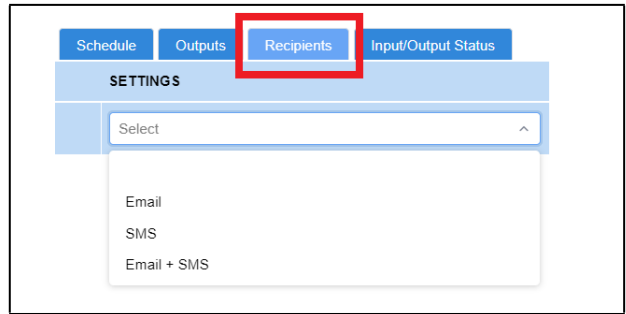

Figure 6-9 - Recipients Tab

- Recipients** - For each user, select how the alarm will be communicated. The first column shows the list of users while the second column shows the combo box. The combo box will have 4 selections: Disabled (blank), Email, SMS (Text), and Email + SMS. The default value will be "Disabled".

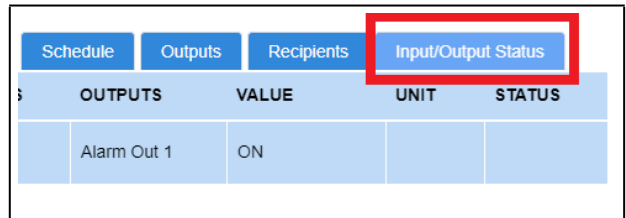

Figure 6-10 - Input/Output Status Tab

- Input/Output Status** - The Input/Output Status tab of every application will appear as a new tab on the details summary screen to view all the necessary properties to troubleshoot any issues more effectively.

Step 3: Click Save

- Click **Save** in the upper right side of the screen. When all fields for the new alarm notice are completed, a confirmation pop-up screen will appear.

NOTE: Only 20 notices can be created. To edit the current notice, a specific role is required in this function.

6.3 Alarm Log and View History

The number of active alarms showing in the upper right corner of the screen next to the bell icon, reflects the number of active alarms without including alarms that have been acknowledged "ACK" and muted "MUTE."

The number of active alarms on the Alarm page (when the bell icon is clicked) is counting all active alarms including alarms that have been acknowledged "ACK" and muted "MUTE." Therefore there may be a difference between these two alarm counts.

Select the **Active Alarms** icon to open the Alarm Log screen and view the list of active alarms in the system:



Figure 6-11 - Alarm Log

The alarm name appearing in the Description column is the default name or custom name assigned to the alarm. Click **View History** to see the collection of alarms that have been resolved.

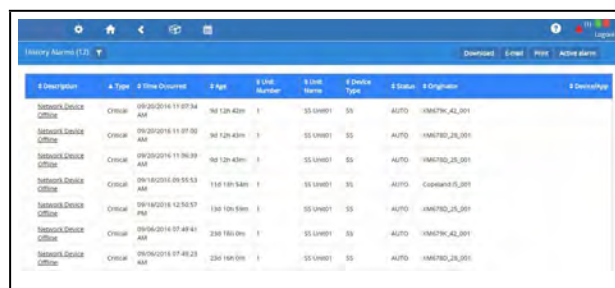

Figure 6-12 - Alarm History

Active alarms also appear as default on the Home screen.

6.4 Temperature Differential Alarms

Once the newly requested points are correctly set, alarms are generated when the real values do not meet the TD setpoint.

| Name | Property Details | | | Visibility |
|------------------------------------|---|----------|-----|--|
| | Value Range | Default | Log | |
| Differential Temperature Selection | Space, Zone, Mixed, Return or None. | N/A | N/A | When the point is set as Space, Zone, Mixed or Return respectively, the Heat Alarm Diff, Cool Alarm and Diff Alarm properties are visible. |
| Heat Alarm Diff (Differential) | 0~54.00DDF | 18.00DDF | N/A | Refer to the interpretation above. |
| Cool Alarm Diff (Differential) | 0~54.00DDF | 18.00DDF | N/A | Refer to the interpretation above. |
| Differential Alarm | Notice; Critical; Non-critical; Disable | Notice | N/A | Refer to the interpretation above. |

Table 6-1- Alarm Properties

The four points added to the AHU application are to ensure that two kinds of alarms are generated respectively, and they are listed in the table below:

| Alarms Type (Same alarm short description) | Conditions Alarms Generate |
|--|---|
| Alarms by Heat Alarm Diff | The supply temperature value is not higher than the user-specified sensor's value by at least the Heat Alarm Diff amount. If the supply temp value is higher than the user-specified sensor's value by the Heat Alarm Diff amount or more, the previously generated alarm returns to normal. |
| Alarms by Cool Alarm Diff | The supply temperature value is not lower than the user-specified sensor's value by at least the Cool Alarm Diff amount. If the supply temp value is lower than the user-specified sensor's value by the Cool Alarm Diff amount or more, the previously generated alarm returns to normal. |

Table 6-2- Alarms Generated from AHU Application

For the CC T-Stats device, three properties need to be added in the Alarms tab, and they are listed in the table below:

| Name | Property Details | | | Visibility |
|-----------------|--|----------|-----|---|
| | Value Range | Default | Log | |
| Diff Alarm | Notice; Critical; Non-critical; Disable | Disable | N/A | When this property is set as Disable, below two properties will not be visible. |
| Heat Alarm Diff | 0~54.00DDF | 18.00DDF | N/A | Refer to the interpretation above. |
| Cool Alarm Diff | 0~54.00DDF | 18.00DDF | N/A | Refer to the interpretation above. |

Table 6-3- Alarm Properties in T-Stats

The points added to the T-Stat devices are to ensure that two kinds of TD alarms are generated respectively, and they are listed in the table below:

| Alarms Type (Same alarm short description) | Conditions Alarms Generate |
|---|---|
| Alarms by Heat Alarm Diff | <p>When the system goes to heating control, an alarm is generated when the Supply Air Temp value is not higher than the Space Temp value by at least the Heat Alarm Diff amount.</p> <p>If the Supply Air Temp value is higher than the space temp value by the Heat Alarm Diff amount or more, then the previously generated alarm returns to normal.</p> <p>About the Space Temp Value:</p> <ol style="list-style-type: none"> 1. System uses the Rem Space Temp value as the space temp value if Remote Spc Temp is set as Yes. 2. System uses the value from a physical space temp probe as the space temp if such a probe is installed. 3. Remote Spc Temp is set as No |
| Alarms by Cool Alarm Diff | <p>When the system goes to cooling control, an alarm is generated when the Supply Air Temp value is not lower than the Space Temp value by at least the Cool Alarm Diff amount.</p> <p>If the Supply Air Temp value is lower than the Space Temp value by the Cool Alarm Diff amount or more, then the previously generated alarm returns to normal.</p> <p>The rules that system chooses the Space Temp value is the same as those for alarms by Heat Alarms Diff.</p> |

Table 6-4- Alarms Generated from T-Stat

6.5 Lighting Cycle Alarms

Once the newly requested points are correctly set, alarms are generated when the real values exceed the set ones. For the lighting control application, three properties need to be added in the Alarms tab, and they are listed in the table below:

| Name | Property Details | Visibility |
|----------------------------|---|---|
| Max Excessive Light Cycles | There are four types, critical, noncritical and notice, Disable (by default). | |
| Lts Cycle Max | The value can be set in the range of 0~999. | This property is not visible to users when Disable is set for Lts Cycle Type. |

Table 6-5- Alarm Properties

The two points added to the lighting control application are to ensure that the lights are operated correctly in a single day. Once the real value of light cycle exceeds the max cycle set in **Table 6-5**, alarms are created. The starting time for calculating the lighting cycles is set at midnight and ends after 24 hours, which is clearly operated in the background.

For the lighting control application, another two properties needs to be added in the Alarms tab, and they are listed in the table below:

| Name | Property Details | Visibility |
|-----------------|---|--|
| Lts On Too Long | There are four types, critical, noncritical and notice, Disable (by default). | N/A |
| Lts On Lng Del | The value can be set in the range of 0~999. | This property is not visible to users when Disable is set for Lts on lng Type. |

Table 6-6- Alarm Properties Added in Lighting Control Application

An alarm is generated if the lights are on for more than the Lts On Lng Del value set by users in **Table 6-6**.

6.6 Smart Alarming

Smart Alarm is an alarm that gives additional information about alarms and provides suggested corrective actions. It creates conditional statements that will compare conditions and generates a notification when these conditions are met. These alarms use all the current transmission methods - SMS, email and MSSR - and include information such as explanations, relevant data, brief graphs, possible causes and suggested actions. Some specific alarms are temperature differential, excessive cycling and sensor data.

CO2 and Enhanced Condenser applications support Smart Alarms.

6.6.1 Accessing Smart Alarms

1. Log into the Supervisor with a technician or administrator-privileged user credentials.
2. Install the .adf file of a specific Smart Alarm type in the Install Application Description File screen. (An ADF or Application Description File allows a particular device to communicate on the Supervisor. An ADF is required before connecting a non-native device on the Supervisor. The ADF can be uploaded on the Supervisor using the File Management screen. A license key is required to activate the application after the ADF has been uploaded.)
3. Install the license of the Smart Alarming feature in the Licensing screen.
4. To add a Smart Alarm application instance in the Control Programming screen, select **Control Programming** from the Main Menu, select **Smart Alarm** from the drop-down list under Control/Application Type drop-down and enter the number of applications in the **Quantity** field.
5. Configure the Smart Alarm application instance in the Device Details screen. Select or enter the correct values in Name, Long Name, Category, and Related Application/Devices parameters.

Related Application/Devices lists all applications or devices that can be associated with the Smart Alarm. If one or multiple applications or devices are selected, they will work with the Smart Alarm together.

- In **View Mode**, the selected applications or devices will display as links. If a link is clicked, it will open the Details screen of the selected application or device.
- In **Edit Mode**, these related applications or devices will display as checkboxes.

When the trigger conditions of the Smart Alarm are complete, a Smart Alarm will be generated and displayed in the Active Alarms screen.

Active Alarms Screen:

- If alarms display as a table in the Active Alarms screen, a light bulb icon will appear beside the Smart Alarm's Description column.
- If alarms display as a card in the Active Alarms screen, a light bulb icon will appear at the top right corner of the card; its color will change depending on the alarm type.

History Alarms Screen:

- If alarms display as a table in the History Alarms screen, a light bulb icon will appear beside the Smart Alarm's description column.
- If alarms display as a card in the History Alarms screen, a light bulb icon will appear the top right of corner of the card.

Note: The alarm indicators (icon and border color) in the Main Header, Main Menu, and Site Summary screens are always displayed even when there are no Smart Alarms in the system.

In the Filter Alarms screen, the Smart Alarm checkbox can be selected under Category to filter Smart Alarms. The Smart Alarm checkbox is always displayed when there are no Smart Alarms in the system.

1. The Critical Alarm screen will display if a Smart Alarm in the Active Alarms or History Alarms screen is selected. A light bulb icon will appear beside the dialog header. There are three actions for Smart Alarm: Acknowledge, Reset, and Mute - their functionalities are similar to normal alarms. If the user is not logged in or has not configured the History Alarms screen, the Actions area will be hidden.

For Smart Alarm

- **Four properties** - Explanation, Possible Cause, Suggesting Actions, and User Defined Message display at the top of the Details list.
- **Originator, Report Value, and Limit Value** properties may have multiple items.
- **Report Value** and **Limit Value** properties are always displayed.
- The **View Graph** button appears on the right side of the Details list header. The log graph of the current Smart Alarm will appear if the View Graph button is clicked.

For devices with small screens, the Details list of the Smart Alarm will be compressed. If there is not enough space to show the graph, use the horizontal scrollbar to adjust.

6.7 Peer Alarming

Peer Alarming enables both the E2 and the Supervisory Controller to transmit the alarms to the alarm annunciator controller in a peer group. The general operations for the integrated alarms can then be handled in one controller making it more convenient for users to manage and deal with all the alarms in only one annunciator in one peer group. For more information about Peer to Peer setup, go to **Appendix E: Peer to Peer Network Setup for Mixed Sites (Two Supervisors and One E2)**.

6.8 Generic Alarms

Generic Alarms enable users to custom-assign alarms in the controller for any analog or digital output and allows users to set custom high-low alarm setpoints for both occupied and unoccupied building states. Up to 10 generic alarms can be created for each application. Each alarm is configurable with options of Disabled, Notice, Non-Critical, or Critical. For each alarm the standard Advisory parameters are also available. Generic Alarms must first be enabled in the General System Properties > System Values tab. To set up Generic Alarming in any application, go to the application's Generic Alarms tab. To add a Generic Alarm, select an output from the drop-down list and then click + **Add Generic Alarm**. Each added alarm will be named Generic Alarm, enumerated from 1-10, and followed by the name of the output to which it is assigned. Each alarm's parameters will be hidden beneath the first row. Click the chevron to access all the alarm parameters. The alarm will be generated when the value of the output exceeds the setpoint after the programmed alarm delay is satisfied. Removing a Generic Alarm can be accomplished by clicking the X at the end of its first row.

6.9 Alarm Types

For a list of alarms in the Supervisor, please see **Appendix A: Alarm Advisories**

7 RS485 I/O Network Boards and Peripherals

Site Supervisor has up to two RS485 network ports, each of which may be configured as an I/O network or MODBUS port.

7.1 The I/O Network

Most of the general purpose input and output communications devices required by the Supervisory Controller to control refrigeration systems are connected via the I/O Network. The I/O Network is a simple RS485 three-wire connection that allows data interchange between input boards, which read sensor values and digital closures, output boards, which carry out commands from Supervisory Controller applications, and the Supervisory Controller itself. All boards and controllers manufactured by Copeland for communication with the Supervisory Controller via RS485 are generally referred to as I/O boards, and the network they are connected to is referred to as the I/O Network (or I/O Net).

A COM port configured as I/O Net may connect with up to 127 I/O boards. This network is used by the Supervisory Controller to read data from the input boards and to send commands to the analog and digital output boards. Some unit controllers, such as CCB case controllers and MultiFlex RCBs, also communicate with the Supervisory Controller via the I/O Network.

7.2 I/O Board Names and Terminology

There are many input, relay output, analog output, and combination I/O boards available from Copeland for use with the Supervisory Controller. However, separate from the various MultiFlex unit controller models, the Supervisory Controller only recognizes four different types of I/O boards: 16AI, 8RO, 4AO, and 8DO. All Site Supervisor-compatible I/O boards communicate with the Site Supervisor as if they are one or more of these types of boards.

7.2.1 MultiFlex Boards

The MultiFlex line of control system boards provides a wide variety of input, output, and smart control solutions, all of which are based on a single universal hardware platform. The board design uses flash-uploadable firmware and plug-in expansion boards to configure the base platform board and apply it for use as an input board, relay output board, analog output board, or a combination I/O board.

7.2.1.1 MultiFlex 16 Input Board

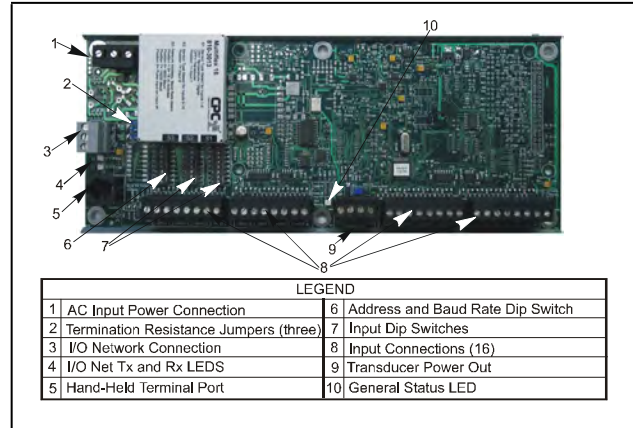

Figure 7-1 - MultiFlex 16 Input Board

The MultiFlex 16 input board offers sixteen combination analog/digital input points for use by Site Supervisor, Einstein, and REFLECS control systems. The MultiFlex 16 may be used in retrofits with no additional hardware or software setup or upgrades.

The MultiFlex 16 is designed to be 100% compatible with the previous generation of input boards (the 16AI), communicates with the site controller via an RS485 connection to a REFLECS COM A&D Network or a Site Supervisor I/O Network. Dip switches on the board set the network ID (board number) and baud rate.

The board also provides both +5VDC and +12VDC output voltage points for use in powering transducers or other input devices that require power.

The MultiFlex 16 has a Hand-held Terminal interface **Section 7.2.8, Hand-held Terminal (P/N 814-3110)** that may be used by technicians to view the input voltage and engineering unit values for each input point without need of a voltmeter or front panel controller display.

Table 7-1 shows the part number of the MultiFlex 16.

| P/N | Model Name | Description |
|----------|--------------|--------------------------------------|
| 810-3013 | MultiFlex 16 | 16 analog/digital inputs, no outputs |

Table 7-1 - MultiFlex 16 Input Board Model

The MultiFlex 16 is designed with several features that make it easy to install, wire, and configure. These main user interface features are shown in **Figure 7-1**.

7.2.1.2 MultiFlex Combination Input/Output Boards



Figure 7-2 - Non-RoHS MultiFlex Combination Input/Output Board (Side View)



Figure 7-4 - RoHS MultiFlex Combination Input/Output Board (Side View)

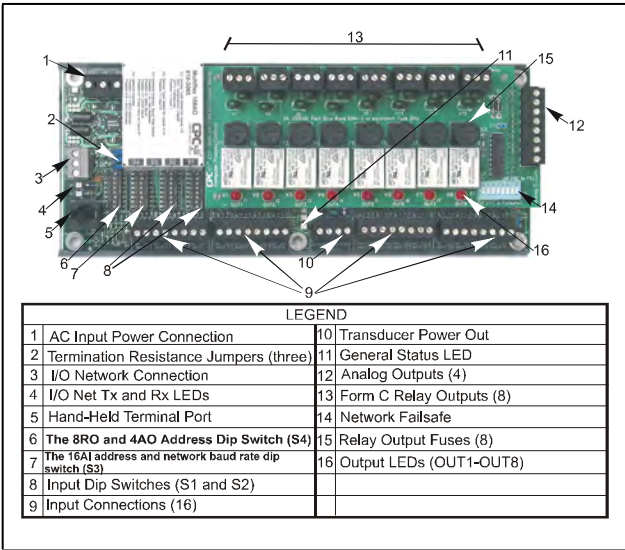

Figure 7-3 - Non-RoHS MultiFlex Combination Input/Output Board (Top View)

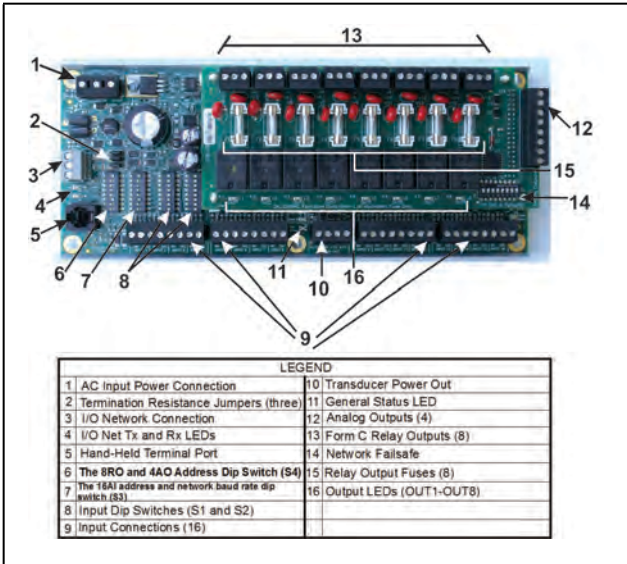

Figure 7-5 - RoHS MultiFlex Combination Input/Output Board (Top View)

There are several models of the MultiFlex board that combine the functionalities of input boards, relay output boards, digital output boards, and analog output boards. The MultiFlex combination input/output boards are designed to be replacements for the 8IO Combination Input/Output Board, but the MultiFlex board provides several new hardware options and software features.

The MultiFlex combination I/O boards consist of up to 16 combination digital/analog inputs, and a combination of relay outputs, digital outputs, and analog outputs.

All boards feature both +5VDC and +12VDC output voltage points for use in powering transducers or other input devices that require power.

On the RS485 Network, the MultiFlex combination input/output boards present themselves to site controllers as 16AI Analog Input Boards, 8RO Relay Output Boards, 8DO Digital Output Boards, and/or 4AO Analog Output Boards, depending on what type of inputs or outputs are equipped. Dip switches are used to assign network ID numbers to each board type.

The MultiFlex combination input/output boards also support a Hand-held Terminal interface, **Section 7.2.8, Hand-held Terminal (P/N 814-3110)** which allows technicians to view input values, check relay and analog output states, and override output points with fixed digital or analog values. For more information on MultiFlex I/O boards, refer to the *MultiFlex I/O Board Installation and Operation Manual (P/N 026-1704)*.

Table 7-2 shows the available models of MultiFlex combination input/output boards with description and part numbers.

| P/N | Model Name | Description |
|----------|-------------------|--|
| 810-3063 | MultiFlex 88AO | 8 analog/digital inputs, 8 relay outputs, 4 analog outputs |
| 810-3064 | MultiFlex 88 | 8 analog/digital inputs, 8 relay outputs |
| 810-3065 | MultiFlex 168AO | 16 analog/digital inputs, 8 relay outputs, 4 analog outputs |
| 810-3066 | MultiFlex 168 | 16 analog/digital inputs, 8 relay outputs. |
| 810-3067 | MultiFlex 168DO | 16 analog/digital inputs, 8 relay outputs, 4 digital outputs |
| 810-3072 | MultiFlex 1616L | 16 analog/digital inputs, 16 low-voltage (24VAC rated) relay outputs |
| 810-3073 | MultiFlex 1616LAO | 16 analog/digital inputs, 16 low-voltage (24VAC rated) relay outputs, and 4 analog outputs. |
| 810-3077 | MultiFlex 1616LDO | 16 analog/digital inputs, 16 low-voltage (24VAC rated) relay outputs, and 4 pulse-width modulating digital outputs |

Table 7-2 - MultiFlex Combination Input/Output Board Models

7.2.2 MultiFlex CUB Support

The MultiFlex Condensing Unit Board (CUB) is a “smart” input/output board designed to control single condensing units. A single condensing unit is a self-contained compressor and condenser bearing unit which controls refrigeration in a single case line-up or walk-in cooler. The MultiFlex CUB uses the same general hardware configuration as a MultiFlex 168AO. It is equipped with a processor and extra memory to allow it to control compressors, condensers, refrigeration, and defrost for a single condensing unit using on-board I/O and control algorithms. The MultiFlex CUB has its own installation and operation manual, (P/N 026-1705).



Figure 7-6 - MultiFlex Condensing Unit (CUB)

7.2.3 MultiFlex RTU Support

This MultiFlex RTU (Rooftop Unit Board) support allows you to set the inputs, outputs, setpoints and alarms on the user interface, and transmit the data through I/O network between RTU board and Site Supervisor.

7.2.3.1 I/O Network and MultiFlex RTU Setup on Serial Port

1. Navigate to serial port configuration screen, select an unused port and configure it as an I/O network port.
2. Configure the baud rate of the I/O network port, then select **MultiFlex RTU** from the supported board types for this port. Set the number of board needed to setup, click **Save** to add the RTU devices. RTU board status will appear “Online”.
3. Navigate to the “HVAC - RTU_0X” device status screen through the site map, the status screen displays the following sections:
 - General
 - Inputs
 - Outputs

- RTU Outputs
4. Click **Details** on the status screen, the system will display the properties of the RTU board by the properties group. You can now view and configure the properties of the RTU board.
 5. After configuring the properties, the new values can be sent to RTU application on the Supervisory Controller and RTU board on the I/O network. The RTU board can now work correctly on the controller.

7.2.3.2 Creating an Instance of RTU Application

You can create an instance of RTU application even if the RTU board is not connected to the Supervisory Controller, however the board status is displayed "Offline".

If the RTU board is connected to the supervisory controller through the I/O network, the supervisory controller should find the RTU board and its property values and should be read on the controller through the I/O network.

7.2.3.3 Deleting/Checking Status of RTU Board

You can navigate to Network Summary screen to do the following operations:

1. View all the devices connected to the Site Supervisor from the I/O network and its online status.
2. Delete a device.
3. View the I/O network traffic status.
4. Navigate to the summary screen of a specific device.

7.2.3.4 Zone Management

You can associate an RTU application with a zone. Zone is a group of RTUs and/or AHU (air handling unit) applications that shares the same heating, cooling, dehumidification setpoints, and other control parameters. The primary purpose of zone control is to maintain a specific temperature and humidity level throughout a wide area using multiple rooftop units.

When an RTU application is associated with a zone, some inputs of RTU application should use the output values from zone. These are the property mapping list:

| RTU Inputs | Zone Outputs |
|------------|-----------------------|
| ZONE OCC | ZONE_OCC_STATE |
| ZONE TEMP | ZONE_TEMP_OUT |
| ECONMIZE | ZONE ECON OK |
| DEHUMDIFY | ZONE DEHUM ACTIVE |
| OCC HEAT | ZONE HEAT OCC OUT |
| UNOCC HEAT | ZONE HEAT UOC OUT |
| OCC COOL | ZONE COOL OCC OUT |
| UNOCC COOL | ZONE COOL UOC OUT |
| OCC DEHUM | ZONE FB HUMID STPT |
| SEASON | ZONE_SUM_WIN_MODE_OUT |

Table 7-3- RTU and Zone Property Mapping List

7.2.3.5 Scheduling

Daily (from Monday to Sunday) schedules of Occupied/Unoccupied state can be set and send to the RTU board.

7.2.3.6 Alarming

Alarms generated from RTU board will be received and reported by Alarm management in Site Supervisor. You can configure the attribution, type and category of the alarms generated from RTU board.

Any reset or clear actions performed on the UI is forwarded to the RTU board.



NOTE: The RTU does not have the capability of resetting individual alarms. All alarms on the RTU will be reset or cleared by the RTU if anyone resets or clears the alarms in the Supervisory Controller.

7.2.3.7 Real Time Clock Updates

Current system date or time is sent to the RTU board periodically with a 10-second interval.

7.2.3.8 Hand-Held Terminal Support

1. You can connect to the RTU board with a hand-held terminal (HHT) to read or write the configuration of this RTU board.
2. When a HHT is connected to a RTU board, any setpoint change made from UI will not be sent to the RTU board. Some controllers will accept the changes but some will not.

- The Supervisory Controller downloads all setpoints and configuration parameters you changed from UI upon receipt of a message from the RTU that the hand-held terminal is disconnected. This will overwrite any changes made using the HHT.
- The Supervisory Controller does not accept permanent changes made via the hand-held terminal to the Supervisory Controller.

7.2.4 MultiFlex RCB Support

7.2.4.1 I/O Network and MultiFlex RCB Setup on Serial Port

- Navigate to serial port configuration screen, select an unused port and configure it as an I/O network port.
- Configure the baud rate of the I/O network port, then select **MultiFlex RCB** from the supported board types for this port. Set the number of board needed to setup, click **Save** to add the RCB devices. RCB board status will appear Online.
- Navigate to the "HVAC - RCB_0X" device status screen through the site map, the status screen displays the following sections:
 - General
 - Alarm Outs
 - Inputs
 - Outputs
 - RCB Outputs
- Click **Details** on the status screen, the system will display the properties of the RCB board by the properties group. You can now view and configure the properties of the RCB board.
- After configuring the properties, the new values can be sent to RCB application on the Supervisory Controller and RCB board on the I/O network. The RCB board can now work correctly on the controller.

7.2.4.2 Creating an Instance of RCB Application

You can create an instance of RCB application even if the RCB board is not connected to the Supervisory Controller, however the board status is displayed "Offline".

If the RCB board is connected to the supervisory controller through the I/O network, the supervisory controller should find the RCB board and its property values and should be read on the controller through the I/O network.

7.2.4.3 Deleting/Checking Status of RCB Board

You can navigate to Network Summary screen to do the following operations:

- View all the devices connected to the Supervisory Controller from the I/O network and its online status.
- Delete a device.
- View the I/O network traffic status.
- Navigate to the summary screen of a specific device.

7.2.4.4 Zone Management

You can associate an RCB board with a zone. When an RCB board is associated with a zone, some inputs of RCB should use the output values from zone. The are the property mapping list you can use:

| RCB Inputs | Zone Outputs |
|----------------|-----------------------|
| OCC STATE | ZONE_OCC_STATE |
| ZONE TEMP | ZONE_TEMP_OUT |
| ECON OK | ZONE ECON OK |
| DEHUM ACTIVE | ZONE DEHUM ACTIVE |
| OCC HEAT | ZONE HEAT OCC OUT |
| UNOCC HEAT | ZONE HEAT UOC OUT |
| OCC COOL | ZONE COOL OCC OUT |
| UNOCC COOL | ZONE COOL UOC OUT |
| OCC DEHUM | ZONE FB HUMID STPT |
| SEASON | ZONE_SUM_WIN_MODE_OUT |
| UNOCC DEHUM | ZONE_DEHUM_UNOC_OUT |
| OCC HUMIDITY | ZONE_FB_HUMID_STPT |
| UNOCC HUMIDITY | ZONE_HUM_OUT |

Table 7-4- RCB and Zone Property Mapping List

7.2.4.5 Scheduling

Daily (from Monday to Sunday) schedules of Occupied/Unoccupied state can be set and send to the RCB board.

7.2.4.6 Alarming

Alarms generated from RCB board will be received and reported by Alarm management in the Supervisory Controller. You can configure alarms properties such as:

- Alarm repeat rate
- Alarm type
- Alarm category
- Alarm displayed message
- Alarm monitoring flag

The Alarms generated from the Supervisory Controller for the RCB application are the following:

- Control Temp High
- Supply Temp High
- Return Temp High
- Control Temp Low
- Supply Temp Low
- Return Temp Low

You can set the following attributions for each of the alarms above:

- Alarm repeat rate
- Alarm delay
- Alarm type
- Alarm category
- Alarm displayed message
- Alarm monitoring flag

For the alarms generated by the RCB board, any reset or clear actions you performed in the Supervisory Controller will be forwarded to the RCB.



NOTE: The RCB does not have the capability of resetting individual alarms. All alarms on the RCB will be reset or cleared by the RCB if anyone is reset or clear the alarms in the Supervisory Controller.

7.2.4.7 Real Time Clock Updates

Please refer to **Section 7.2.3.7**, *Real Time Clock Updates*.

7.2.4.8 Hand-Held Terminal Support

Please refer to **Section 7.2.3.8**, *Hand-Held Terminal Support*.

7.2.5 MultiFlex RTU

Similar in design to the MultiFlex combination input/output boards, the MultiFlex RTU board is designed specifically for operating package rooftop HVAC units as part of a Supervisory Controller or REFLECS BCU building control system. The MultiFlex RTU is designed to be a replacement for the previous generation ARTC, and is 100% compatible with all legacy Supervisory Controller and BCU systems.

The MultiFlex RTU board has 16 analog inputs, 8 relay outputs and 4 analog outputs. Most of these I/O points are reserved for sensors and input devices required to read environmental data (such as space and supply air temperature) and control all output devices that control the environment (such as heat/cool stages and dampers). Both auxiliary inputs can be configured for a variety of sensor types including any type of linear sensor. For linear sensors, the auxiliary inputs can be configured as Satellites. By doing this, the minimum and maximum voltage and minimum and maximum Engineering Unit parameters are user configurable for these inputs. The RTU relay outputs are rated for line voltage (240VAC).

The RTU board controls the rooftop unit directly with its built-in heating, cooling, and humidity control algorithms. It may operate in stand-alone mode, or it may interface with a Supervisory Controller or BCU to control the store environment in zones and pass along logging and alarm information.

The MultiFlex RTU has its own installation and operation manual (P/N 026-1706).

7.2.6 MultiFlex Rooftop Control Board (RCB)

The MultiFlex Rooftop Control Board (RCB) (P/N 810-3062) is a rooftop HVAC control board for use either as a stand-alone controller or in zone control applications using a Supervisory Controller building control system. The MultiFlex RCB is capable of controlling heat and cool stages, fans, humidification and dehumidification devices, economizers using on-board I/O and control algorithms, as well as monitor and interact with other building control systems and peripherals (such as smoke alarms and CO2 sensors).

The RCB is an improved version of the MultiFlex RTU. The RCB has sixteen fully configurable analog and digital input points, whereas the RTU has only eight inputs, two of which are configurable. The RCB has four analog outputs for use in controlling variable speed fans, economizers or modulating heating and/or cooling valves, whereas the RTU has only two analog outputs for use only with VS fans and economizers. The RCB also features a more sophisticated HHT interface and updated algorithms for controlling heating, cooling, dehumidification, and air quality. The MultiFlex RCB-P (pulse control board P/N 810-3076) uses an alternate control strategy that incorporates logic for controlling heating and cooling functions.

The MultiFlex RCB has its own installation and operation manual, (P/N 026-1707).

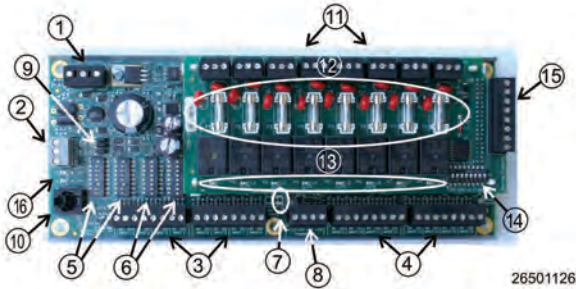

| LEGEND | | | |
|--------|--|----|---|
| 1 | INPUT POWER (24VAC) | 9 | RS485 TERMINATION JUMPERS |
| 2 | RS485 I/O NETWORK | 10 | HAND-Held TERMINAL JACK |
| 3 | RCB INPUTS 1-8 | 11 | RELAY OUTPUT CONNECTORS |
| 4 | RCB INPUTS 9-16 | 12 | RELAY OUTPUT FUSES (2A rated, 250V slow-blow) |
| 5 | NETWORK ID DIP SWITCHES (S3, S4) | 13 | RELAY STATUS LEDs |
| 6 | INPUT TYPE DIP SWITCHES (S1, S2) | 14 | OUTPUT FAIL-SAFE SWITCHES |
| 7 | BOARD STATUS LEDs (Code A, Code B, General Status) | 15 | ANALOG OUTPUTS |
| 8 | DC POWER OUTPUTS (3 at +5VDC, 1 at +12VDC) | 16 | NETWORK STATUS LEDs |

Table 7-5 - MultiFlex RCB

7.2.7 The MultiFlex ESR Board

The MultiFlex ESR Valve Regulator board (P/N 810-3199), shown in **Figure 7-7**, is an RS485 I/O Network electronic stepper valve regulator capable of driving up to eight stepper motor valves, which are typically used to control temperature.

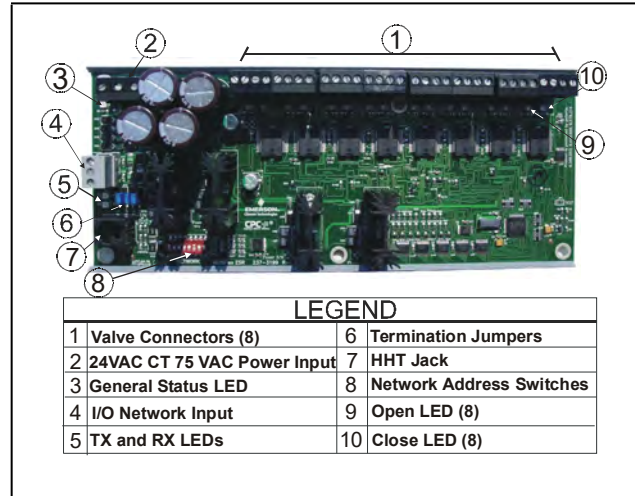

Figure 7-7 - MultiFlex ESR Board Layout

The MultiFlex ESR uses suction side variable-position evaporator regulators (ESRs) to vary evaporator pressure for an entire circuit and is an alternative to mechanical EPR control.

The MultiFlex ESR receives input data from Supervisory Controller (via the I/O Network) and then regulates the stepper valves according to the data from the Supervisory Controller.

Each MultiFlex ESR board requires a Class 2, 80VA 24VAC center-tapped transformer for power. Transformer (P/N 640-0080) is a multi-tapped primary transformer that may be used with the MultiFlex ESR board.

7.2.8 Hand-held Terminal (P/N 814-3110)

The Hand-held Terminal (HHT) is used by manufacturers and service technicians to diagnose and test several of Copeland’s existing and legacy products. The HHT can be used on any Copeland product with an RJ-11 connector. The most common applications include:

- All MultiFlex I/O boards and the 8ROSMT
- All Gateway boards
- Stand-alone MultiFlex boards (RTU, RCB, PAK, CUB)
- CCB and CC-100 case controllers

The HHT does not require a separate power source. The unit is powered from the RJ-11 connector on the peripheral equipment. The HHT includes a standard male RJ-11 to male RJ-11 cable.

NOTE: The 9V battery and 9-12VDC adapter connection are not used on this HHT model (P/N 814-3110).

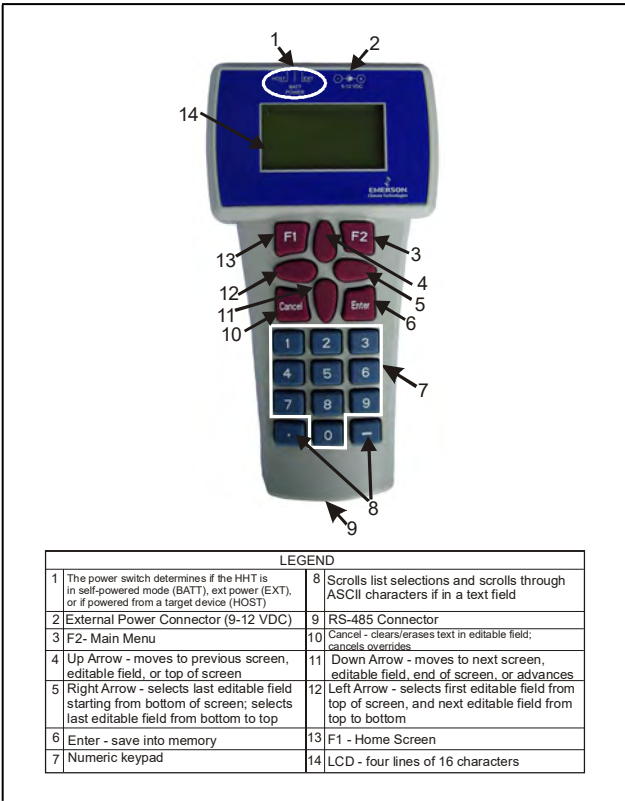

Figure 7-8 - Hand-held Terminal (814-3110)

7.2.9 The 8RO and 8ROSMT Relay Boards

The 8RO (P/N 810-3005) board is a general-purpose board used to connect a Supervisory Controller to any of eight standard control relay outputs, but is now obsolete and has been replaced by the 8ROSMT (P/N 810-3006) board.

To function, the 8RO board must be connected through either the Echelon Network or the RS485 I/O Network to the Supervisory Controller. When properly installed, the 8RO receives an electrical impulse from the Supervisory Controller, which either opens or closes any of eight contact relays. Output definitions within the Supervisory Controller allow the user to configure the 8RO board to

interact with any refrigeration system or environmental control component.

The 8RO board is the direct link between the supervisory controller and component operation. Information gathered by the controller from the input boards is checked against current stored setpoints. If differences in the received input data and the setpoint information are detected, a signal is either sent to the proper 8RO relay, or an existing signal is discontinued. Through the use of this relay signal, control functions that can be properly maintained by a simple contact closure sequence are effectively operated by the Supervisory Controller.

The 8RO board is easily installed and operated within the Copeland Network environment because of its straightforward design. Several of these features are shown in **Figure 7-9**.

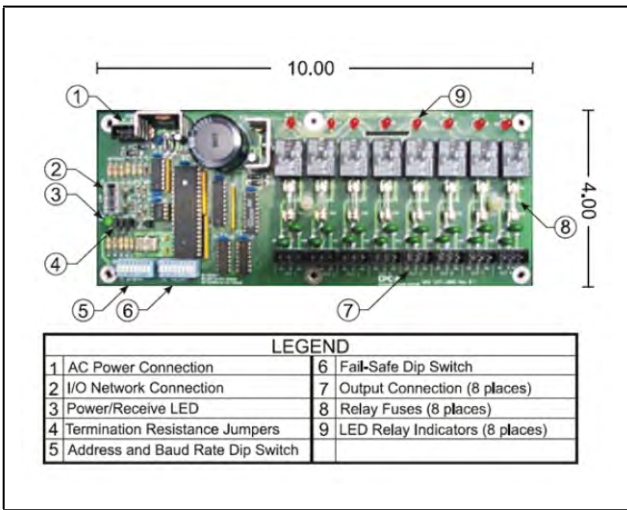

Figure 7-9 - 8RO Relay Output Board

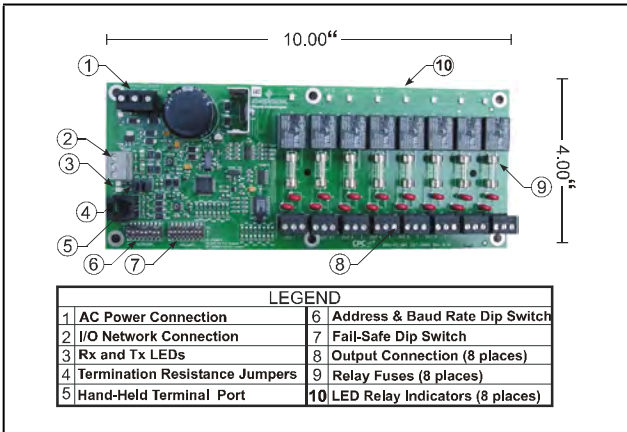

Figure 7-10 - 8ROSMT Relay Output Board

7.2.10 4AO Analog Output Board

The 4AO Analog Output Board (P/N 815-3030) (Figure 7-11) is configured with four analog output connections that provide a variable voltage signal to any of four analog devices that may be controlled by a single Supervisory Controller. Two 4-20mA outputs are provided for channels 1 and 2. The 4-20mA outputs provide a variable current for applications that are either externally powered or that require power from the 4AO board.

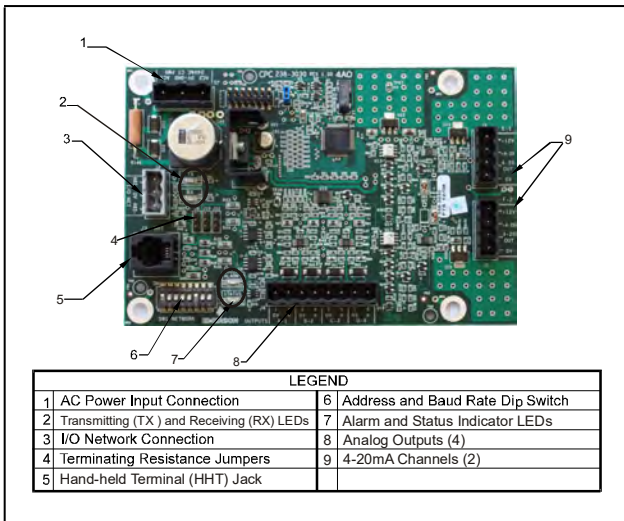

Figure 7-11 - 4AO Analog Output Board (P/N 815-3030)

7.2.11 8DO Digital Output Board

For control of anti-sweat heaters, Copeland supplies the 8DO Digital Output board (P/N 810-3050). The 8DO has eight outputs which may pulse up to 150mA at 12VDC.

The 8DO is primarily designed to control anti-sweat heaters. The 8DO is shown in Figure 7-12.

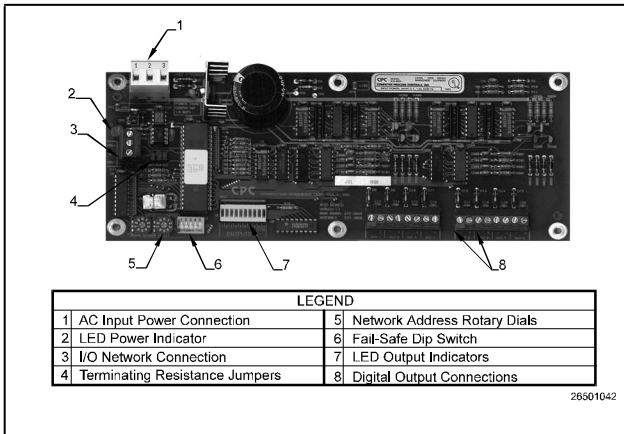

Figure 7-12 - 8DO Digital Output Board

7.2.12 XM Series of Case Controllers

The XM series is a set of digital case controllers for low to medium units. The XM series control refrigeration solenoids and defrost (electric or hot gas), evaporator fans, lights and have an auxiliary output.

7.2.12.1 XM670K v3.4



Figure 7-13 - XM670

The XM670 is high level microprocessor based controllers for multiplexed cabinets suitable for applications on medium or low temperature. It can be inserted in a LAN of up to 8 different sections which can operate, depending on the programming, as stand alone controllers or following the commands coming from the other sections. The XM670 is provided with 6 relay outputs to control the solenoid valve, defrost (which can be either electrical or hot gas) the evaporator fans, the lights, an auxiliary output and an alarm output. The devices are also provided with four probe inputs, one for temperature control, one to control the defrost end temperature of the evaporator, the third for the display, and the fourth can be used for application with virtual probe or for inlet/outlet air temperature measurement. Finally, the XM670 is equipped with the three digital inputs (free contact) and are fully configurable. For more information about the XM670 controller, refer to the controller manual, P/N 026-1218.

7.2.12.2 XM679K v3.4 and v4.2

The XM679 is similar to the XM670, but with one relay output to drive pulsed electronic expansion valves. The XM679 also contains two probes that are dedicated for superheat measurement and regulation. Refer to the XM679 manual (P/N 026-1218) for more information about the device.



Figure 7-14 - XM679

7.2.12.3 XM678D v2.5 and v2.8

The XM678 is similar to the XM670, but with one stepper valve output to drive an electronic expansion valve. The XM678 also contains two probes that are dedicated for superheat measurement and regulation. Refer to the XM678 manual (P/N 026-1219) for more information about the device.



Figure 7-15 - XM678

7.2.13 XEV22 v1.1 and v1.5

The XEV22D controller is capable of driving a wide variety of stepper electronic expansion valves. XEV22D regulates the superheat (SH) of the fluid that runs into refrigerating unit in order to obtain optimized performance and functioning of the evaporator independent by climatic or load conditions. XEV22D modules are equipped with two (2) probe inputs, one for a 4 to 20mA or 0 to 5V pressure transducer and another one for a NTC-EU, NTC-US or PT100 temperature probe.



Figure 7-16 - XEV22D

7.2.14 Wireless I/O

Wireless Module System provides refrigerated case temperature monitoring and control for certain applications without the time and expense required to wire multiple temperature sensors from the case back to the Supervisory Controller. All modules in the Wireless Module System family are wireless, transmitting their values to Gateways in the store area that pass them back to the Supervisory Controller. There can be multiple Gateways at a site. The interface to the supervisory controller determines the number of individual modules that are supported (MODBUS or I/O Net). The recommended number of modules is less than 200 within a 100-foot radius.

- Running MODBUS: supports a maximum of 297 individual modules.
- Running I/O Net: supports a maximum of 356 individual modules.

The wireless module has three inputs where temp sensors can be connected. The module transmits to the gateway, which is connected to the Supervisory Controller via I/O net. The Gateway communicates to the Supervisory Controller over the I/O network. During commissioning and installation, the hand-held (HHT) must be used to address each wireless node. The address appears as an I/O point just like a 16AI MultiFlex board (address 1-16). If there are more than 16 modules, the other 16AI board application must be set up to address the next 16 modules. The HHT is also needed in order to make any changes.

For more information on Wireless Module System, refer to the *026-1734 User Manual*.



Figure 7-17 - Wireless Module P/N 814-36xx

The Wireless Module is an enclosure with a built-in broadcast antenna. This module may be mounted on a refrigerated case, as long as it is within 100 feet clear line-of-site of a Wireless Gateway. Obstructions like walls and doors will reduce range. The module is primarily powered with a solar cell, but it also has battery backup. The user can use an external 5VDC supply if mounted in dark areas.

Table 7-6 lists all Wireless Modules along with their characteristics for US and Canada only (902 MHz).

| Part Number | Description |
|----------------------------------|---|
| Modules for US and Canada | |
| 814-3600 | User Selected inputs |
| Standard Modules | |
| 814-3653 | Molex plug for 3 Std ERS 10K temp sensor + clean mode |

Table 7-6 - Wireless Standard Modules for US and Canada

| Part Number | Description |
|----------------------------------|-------------------------|
| Modules for US and Canada | |
| Digital Modules | |
| 814-3623 | 3 Digital + clean mode |
| Humidity Modules | |
| 814-3633 | 3 Humidity + clean mode |

Table 7-7 - High Temp, Digital, and Humidity Modules for US and Canada

7.2.15 Site Supervisor Displays

See **Section 8, Site Supervisor Displays** for more information.



Figure 7-18 - Supervisory Controller Display

The Site Supervisor Display (P/N 818-7240) is a remote UI for the Site Supervisor Display that connects to the controller. For Site Supervisor Display 15.6 Inch and 21.5 Inch Display information, see **Section 8, Site Supervisor Displays**.

7.2.16 Programmable Touchscreen Thermostat

The Programmable Touchscreen Thermostat (P/N 810-1600) is a configurable device intended for light commercial applications. The thermostat is a communicating, intelligent sensor and controller combination with built-in temperature and humidity sensors used to control systems such as conventional Rooftop Units (RTU) and Heat Pumps (HP). The thermostat communicates over a Modbus RTU network that easily integrates with a building management system (BMS).



Figure 7-19 - Programmable Touchscreen Thermostat



Figure 7-20 - Control Techniques Drive

7.2.18 DAC

The DAC is a packaged HVAC control board for use either as a stand-alone controller or in zone control applications using a Copeland building control system. The DAC is capable of controlling heat and cool stages, fans, humidification and dehumidification devices and economizers using on-board I/O and control algorithms, as well as monitor and interact with other building control systems and peripherals (such as smoke alarms and CO2 sensors).

7.2.17 Control Techniques Drive (VSD)

Using the MODBUS network type, supervisory controllers can communicate with the Control Techniques variable-speed drive (VSD). There are three different VSD models the Supervisory Controller communicates with: Commander SE, Commander SK, and Unidrive SP drive types.

Note that all CT drives are 2 stop bits, with no parity. Since ECT MODBUS specifies 1 stop bit, CT drives will configure the General Services setting for stop bits and always communicate with the drives using 2 stop bits. The Supervisory Controller calculates the difference and adjusts for the additional stop bit.

Configure the COM port the CT drive will connect to by pressing Alt + M to open the serial configuration manager.

Set the COM port to MODBUS and the baud rate (match the baud rate on the CT drive).

The installation and operation manual explaining the VSD is maintained by Control Techniques. Contact your Control Techniques representative for a copy of the Control Techniques manual.



Figure 7-21 - DAC

7.2.19 Copeland Discus with CoreSense Diagnostics (ISD)

The Intelligent Store Discus™ product line is now available on 2D, 3D, 4D and 6D compressors and integrates a number of important sensing and compressor protection functions. This product provides for on/off control of the compressor, capacity modulation (both conventional blocked suction and with Copeland Discus Digital® capacity modulation) and for communication of the compressor status to the rack controller through a network using MODBUS for Intelligent Store communication protocol. Protection against low oil pressure, excessive discharge protection, high discharge pressure and low suction pressure is standard on every Intelligent Store Discus compressor. A 2-line liquid crystal display on the front of the compressor with a choice of five languages. An LED on the compressor control module indicates at a glance whether or not there are any compressor faults.

7.2.20 Copeland Discus with CoreSense Protection



Figure 7-22 - Copeland Discus Compressor

The Discus application can monitor semi-hermetic compressors using the MODBUS network. The Supervisory Controller monitors and records semi-hermetic compressor information. The Discus application has extensive logging capabilities that record a compressor's Run History, Fault History, and Alarm Status.

7.2.21 Copeland Scroll – K5 Refrigeration Compressor

The Copeland Scroll — K5 Refrigeration Compressor (Lrg Ref Scroll) application can monitor large type compressors using the MODBUS network. The Supervisory Controller monitors and records compressor information, configuration setup, status display, and alarm handling. The Copeland Scroll — K5 Refrigeration Compressor will be associated with the Suction Group from the Compressor Associations screen.

8 Site Supervisor Displays

8.1 10.1-Inch Touchscreen Display

The Site Supervisor 10.1-Inch Display (P/N 818-7240) is a remote user interface for the Site Supervisor that connects to the controller using the Ethernet network through the Ethernet port. The Site Supervisor UI allows users to perform critical actions in the controller quickly. Functions such as lighting overrides, controlling heating and cooling stages, status information, and viewing alarms can all be performed using the 10.1-Inch Display.

Site Supervisor 10.1-Inch Display Quick Start Guide P/N 026-4045.



Figure 8-1 - Site Supervisor 10.1-Inch Display



WARNING! The Supervisory Displays should not be used for purposes different from those described in this manual.

- Displays cannot be used as a safety device.
- When using an external power supply, it is necessary to separate the power of the device from the rest of the electrical devices connected inside the electrical panel.
- Disconnect all electrical connections before any kind of maintenance is performed.
- Do NOT open the Supervisory Display. Do NOT open the panel rear cover when power is applied. Check that the supply voltage is correct before connecting.
- Do not expose to water or moisture: use the controller only within its operating limits to avoid sudden temperature changes with high atmospheric humidity to prevent condensation.
- Wire polarity must be observed: a wrong connection may cause possible malfunctioning and damage to the controller or Displays.

8.1.1 Display Connections

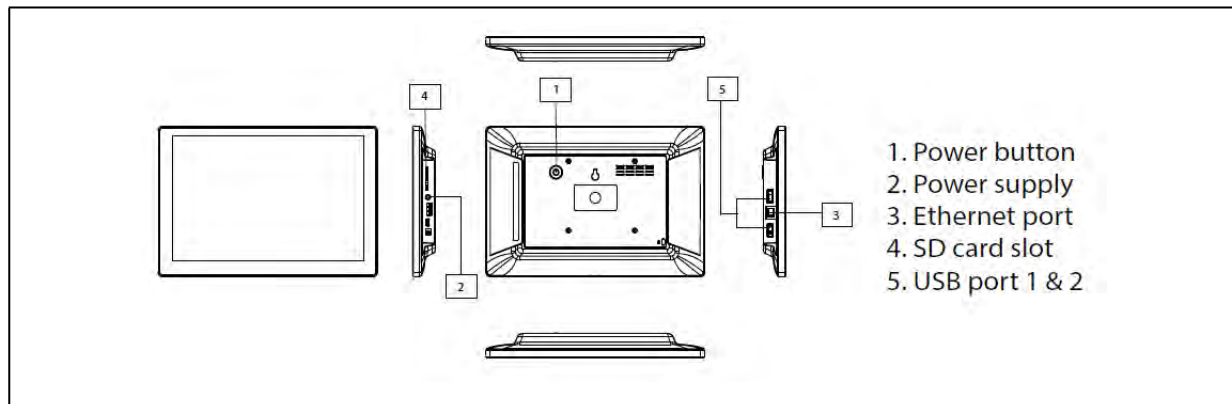

Figure 8-2 - Display Connections for 10.1-Inch Display

8.1.2 Specifications

| 10.1-Inch Display for Site Supervisor | |
|---------------------------------------|---|
| Screen Size | 10.1-Inch |
| Screen Type | Capacitive Multi-Touch |
| Resolution | 1280 x 800 |
| Material | ABS Black |
| Mounting Type | 75mm x 75mm Mount |
| CPU | 1.8 GHZ quadcore |
| Memory | RAM 2GB, HDD 16GB |
| Network | 1 RJ54 Ethernet Port |
| WIFI | Optional |
| Bluetooth | Optional |
| Unit Size | 10.257" x 7.029" x 1.004" (260.54mm x 178.54mm x 25.50mm) |
| Rating | Commercial |
| Temp Rating | -4°F to 140°F (-20°C to 60°C) |
| Power Supply | 12VDC 2A max |

Table 8-1 - Product Specifications

8.1.3 Mounting Dimensions

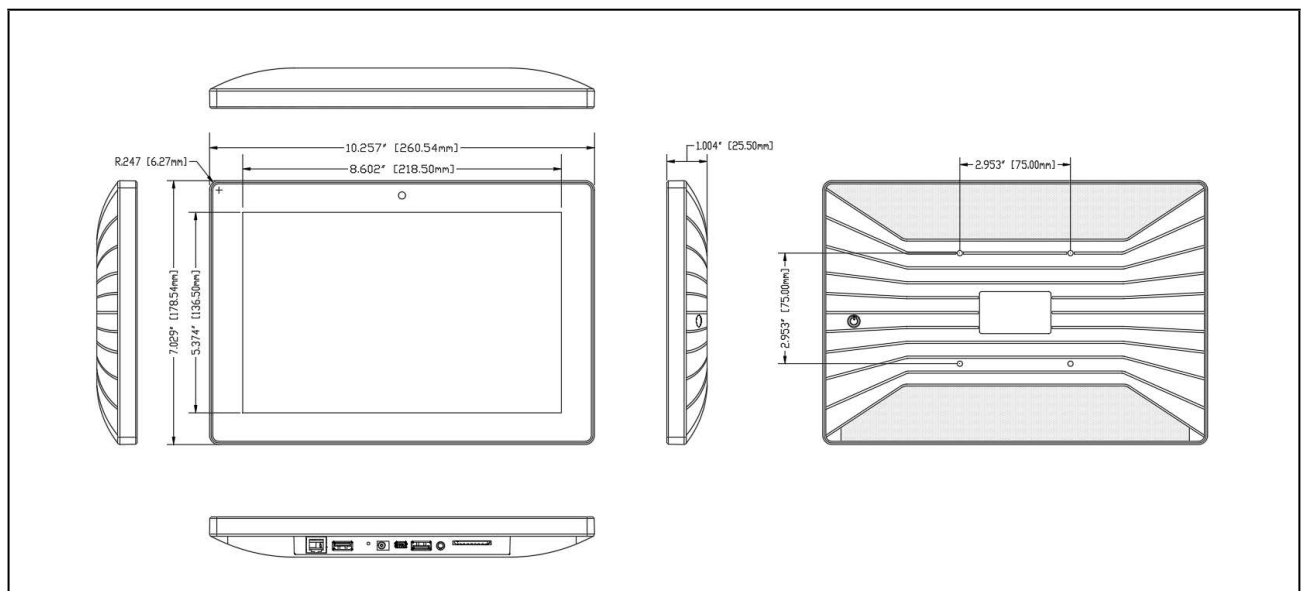

Figure 8-3 - 75mm x 75mm Mount

8.1.4 Direct Connect to Site Supervisor

1. Connect the power supply to the 10.1-Inch Display.
2. Connect one end of the network cable to ETH1 of the Site Supervisor and the other to the Ethernet port of the 10.1 Inch Display.

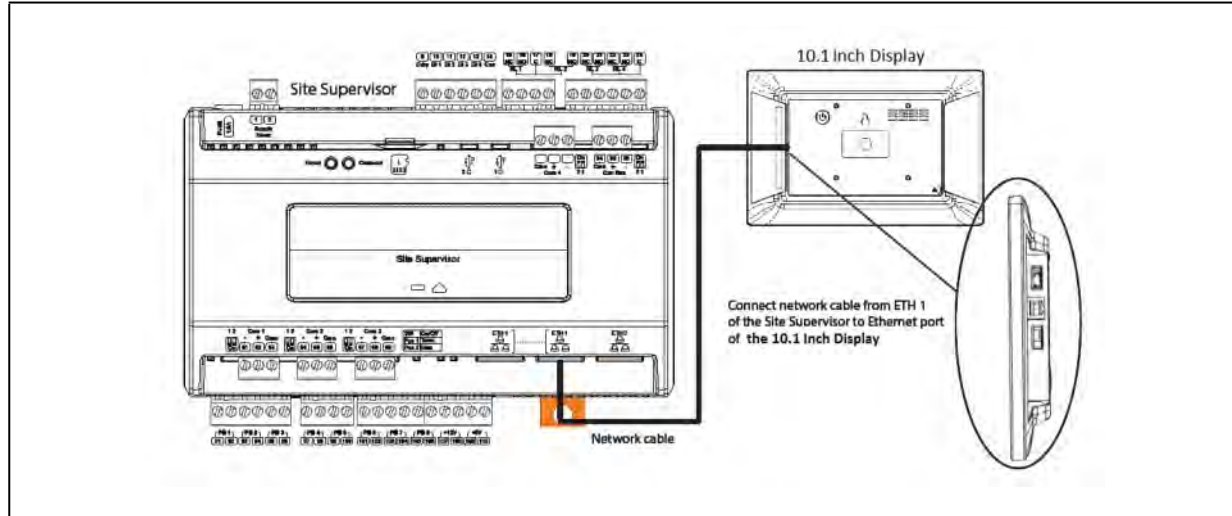



Figure 8-4 - Direct Connect 10.1-Inch Display to Site Supervisor

3. Once you have connected the network cable to the Site Supervisor and 10.1-Inch Display, press the menu icon  and then press the browser icon . You will now have access to the Site Supervisor through the Display.

Note: If the Site Supervisor has already been set up, you can skip steps 4-6 and log into your Site Supervisor. If this is the initial setup of the Site Supervisor, continue following the steps to set up the Site Supervisor.

4. Once you have accessed the Site Supervisor via the 10.1-Inch Display, you will be prompted to log in. The username will be "user" and the password will be "pass."
Note: Look at the lower right of the screen to see the version of the Site Supervisor. If the version is 2.06 or above, you will be prompted to change the password.
5. Once you have changed the password, you will be on the Localization menu in the Setup Wizard. Press the Next arrow key at the top right of the screen.
6. This will take you to the General Setup Parameter where you will need to enter a Site Name. Once the Site Name has been entered, you will be able to log into the Site Supervisor.

8.2 15.6-Inch Touchscreen Display

The Site Supervisor 15.6-Inch Display (P/N 818-7241) is a remote user interface for the Site Supervisor that connects to the controller using the Ethernet network through the Ethernet port. The Site Supervisor UI allows users to perform critical actions in the controller quickly. Functions such as lighting overrides, controlling heating and cooling stages, status information, and viewing alarms can all be performed using the 15.6-Inch Display.

Site Supervisor 15.6-Inch Display Quick Start Guide P/N 026-4054.



Figure 8-11 - Supervisory Controller 21.5-Inch Display

8.2.1 Display Connections

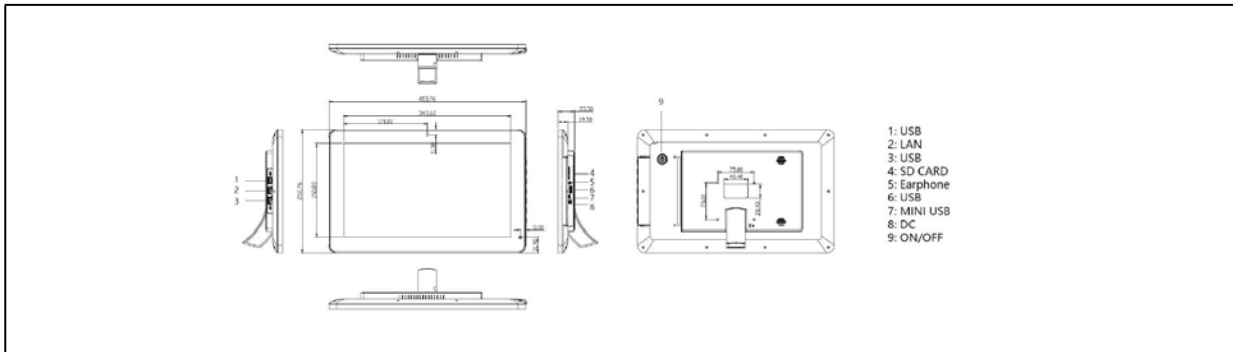

Figure 8-8 - Display Connections

8.2.2 Specifications

| 15.6-Inch Display for Site Supervisor | |
|---------------------------------------|-----------------------------|
| Screen Size | 15.6-Inch |
| Resolution | 1920 x 1080 |
| Mounting Type | 75mm x 75mm Wall Mounting |
| CPU | Quad Core Cortex A9, 1.8GHZ |
| RAM | 2GB |
| Internal Memory | 16GB |
| Operating System | Android 6.0 |
| WIFI | 802.11b/g/n |
| Bluetooth | 4.0 |
| Unit Size | 404 x 253 x 33.5mm |

Table 8-2 - Product Specifications

8.2.3 Mounting Dimensions

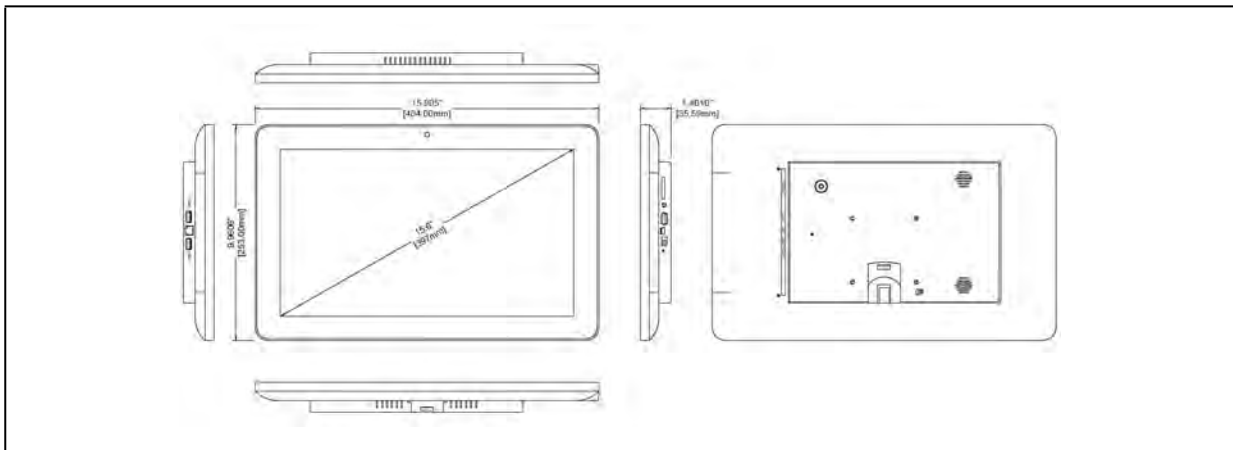

Figure 8-9 - 75mm x 75mm Mount

8.2.4 Direct Connect to Site Supervisor

1. Connect the power supply to the 15.6-Inch Display.
2. Connect one end of the network cable to ETH1 of the Site Supervisor and the other to the Ethernet port of the 15.6-Inch Display.

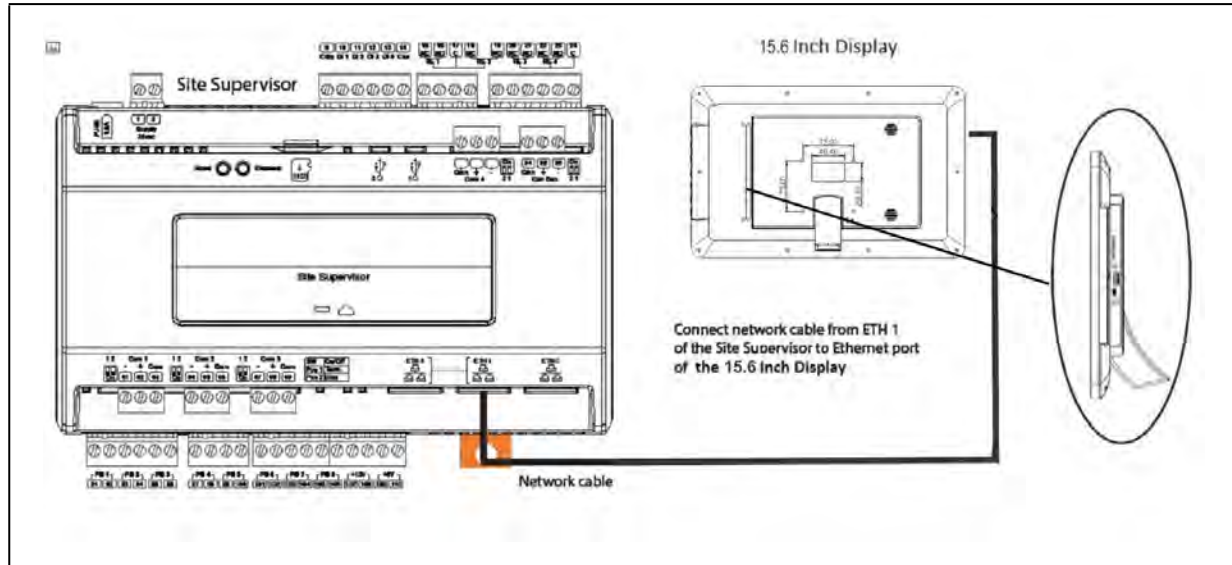



Figure 8-10 - Direct Connect 15.6-Inch Display to Site Supervisor

1. Once you have connected the network cable to the Site Supervisor and 15.6-Inch Display, press the menu icon  and then press the browser icon . You will now have access to the Site Supervisor through the Display.

Note: If the Site Supervisor has already been set up, you can skip steps 4-6 and log into your Site Supervisor. If this is the initial setup of the Site Supervisor, continue following the steps to set up the Site Supervisor.

2. Once you have accessed the Site Supervisor via the 15.6-Inch Display, you will be prompted to log in. The username will be "user" and the password will be "pass."

Note: Look at the lower right of the screen to see the version of the Site Supervisor. If the version is 2.06 or above, you will be prompted to change the password.

3. Once you have changed the password, you will be on the Localization menu in the Setup Wizard. Press the Next arrow key at the top right of the screen.
4. This will take you to the General Setup Parameter where you will need to enter a Site Name. Once the Site Name has been entered, you will be able to log into the Site Supervisor.

8.3 21.5-Inch Touchscreen Display

The Site Supervisor 21.5-Inch Touchscreen Display (P/N 818-7242) is a remote user interface for the Site Supervisor that connects to the controller using the Ethernet network through the Ethernet port. The Site Supervisor UI allows users to perform critical actions in the controller quickly. Functions such as lighting overrides, controlling heating and cooling stages, status information, and viewing alarms can all be performed using the 21.5-Inch Display.

Site Supervisor 21.5-Inch Display Quick Start Guide
P/N 026-4055.



Figure 8-11 - Supervisory Controller 21.5-Inch Display

8.3.1 Display Connections

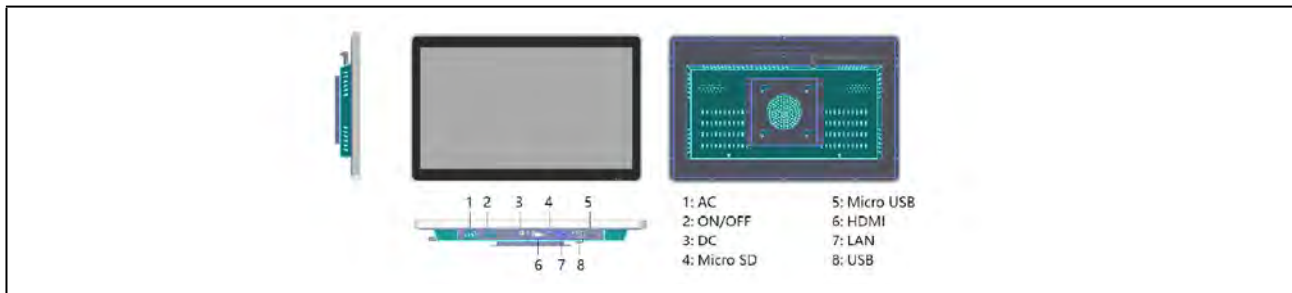

Figure 8-12 - 21.5-Inch Display Connections

8.3.2 Specifications

| 21.5-Inch Touchscreen Display for Site Supervisor | |
|---|-------------------------------|
| Screen Size | 21.5-Inch |
| Screen Type | Capacitive Multi-Touch |
| Resolution | 1920 x 1080 |
| Material | Metal Housing |
| Mounting Type | 100mm x 100mm Wall Mounting |
| CPU | Quad core RK3288, Android 6.0 |
| RAM | 2GB (optional 4GB) |
| Internal Memory | 16GB (optional 32GB) |
| Network | 10M/100M Ethernet Port |
| WIFI | 802.11b/g/n |
| Bluetooth | 4.0 |
| Unit Size | 24.7 x 16.4 x 2.5cm |
| Temp Rating | 14°F to 131°F (-10°C to 55°C) |
| Power Supply | 12V, 3A-5A |

Table 8-3 - Product Specifications

8.3.3 Mounting Dimensions

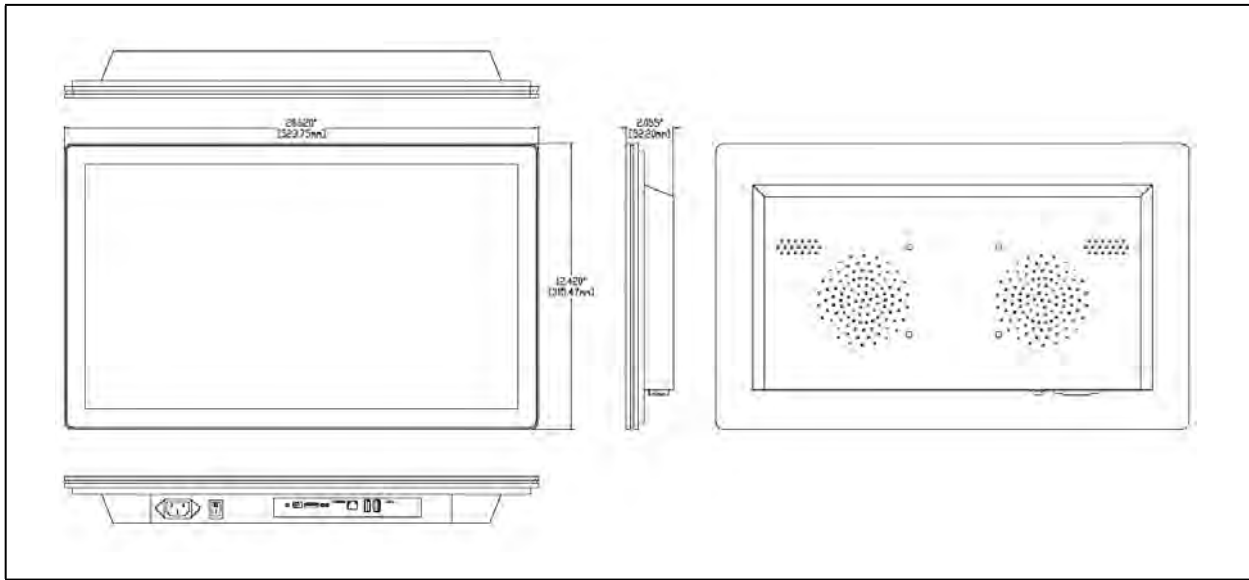

Figure 8-13 - 100mm x 100mm Wall Mount

8.3.4 Direct Connect to Site Supervisor

1. Connect the power supply to the 21.5-Inch Display.
2. Connect one end of the network cable to ETH1 of the Site Supervisor and the other to the Ethernet port of the 21.5-Inch Display.

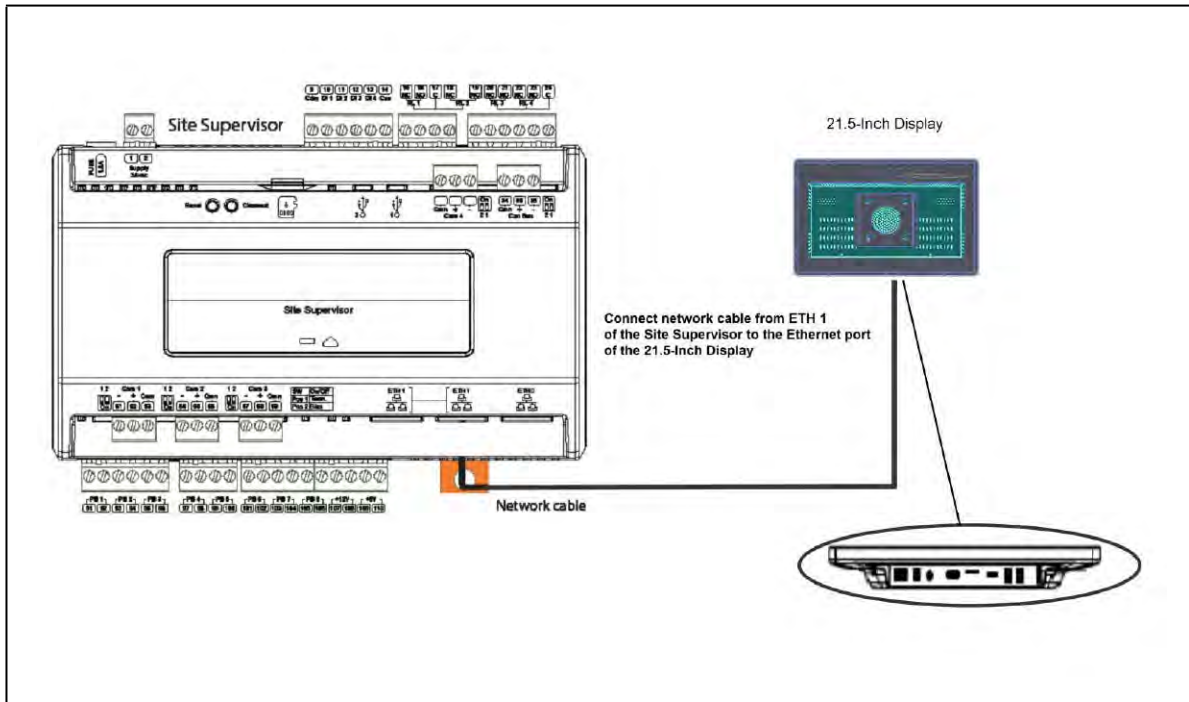



Figure 8-14 - Direct Connect 21.5-Inch Display to Site Supervisor

3. Once you have connected the network cable to the Site Supervisor and 21.5-Inch Display, press the menu icon  and then press the browser icon . You will now have access to the Site Supervisor through the 21.5-Inch Display.

Note: If the Site Supervisor has already been set up, you can skip steps 4-6 and log into your Site Supervisor. If this is the initial setup of the Site Supervisor, continue following the steps to set up the Site Supervisor.

4. Once you have accessed the Site Supervisor via the 21.5-Inch Display, you will be prompted to log in. The username will be “user” and the password will be “pass.”

Note: Look at the lower right of the screen to see the version of the Site Supervisor. If the version is 2.06 or above, you will be prompted to change the password.

5. Once you have changed the password, you will be on the Localization menu in the Setup Wizard. Press the Next arrow key at the top right of the screen.
6. This will take you to the General Setup Parameter where you will need to enter a Site Name. Once the Site Name has been entered, you will be able to log into the Site Supervisor.



8.4 Site Supervisor Touchscreen Display Version Compatibility

| Touchscreen Display Part Number | Touchscreen Display Version | Site Supervisor Version | |
|---------------------------------|-----------------------------|-------------------------|-------------------|
| | | 2.08F01 and Below | 2.10F01 and Above |
| 818-9022 818-9023 | 4.3-Inch | ✓ | x |
| 818-7240 | 10.1-Inch | ✓ | ✓ |
| 818-7241 | 15.6-Inch | ✓ | ✓ |
| 818-7242 | 21.5-Inch | ✓ | ✓ |

Table 8-4- Site Supervisor Touchscreen Display Support Matrix

Note: For complete product part numbers and accessory ordering information, contact your Copeland Sales representative or Customer Service.

9 Software Overview

9.1 Supervisory Controller Application and System Capacity Matrix

Customers are cautioned that the figures in each cell of the following tables may only be interpreted as a general rule-of-thumb number. Values, where appearing in any cell, are intended to represent the designated maximum number for particular application types (as shown in rows) for each Supervisory Controller model/series (as shown in columns), but independent of other application types. In other words, these figures are not indicative of the maximum number of combined applications that can be read by a single Supervisory Controller.

The Supervisory Controller is designed (and required) to handle a combination of multiple applications at the same time. The extent of such combinations that can be added to each Supervisory Controller should only be determined by a qualified Copeland support specialist and will be governed by customized store requirements. In general, just as with computers, each additional input/memory requirement imposed on the Supervisory Controller would reduce the memory available for other applications.

| Application | Supervisor Small Format SF | Refrigeration Supervisor RXS | Refrigeration Supervisor Expanded* RXe | Building Supervisor BXS | Building Supervisor Expanded* BXe | Combination Supervisor CXS | Combination Supervisor Expanded* CXe | Service Replacement SR | Site Aggregator SA | CO2-CXe | CO2-RXe |
|--------------------------------|----------------------------|------------------------------|--|-------------------------|-----------------------------------|----------------------------|--------------------------------------|------------------------|--------------------|---------|---------|
| Email and Text Alarms | ✓ | ✓ | ✓ | ✓ | ✓ | ✓ | ✓ | ✓ | ✓ | - | - |
| Graphical Defrost Summary | ✓ | ✓ | ✓ | ✓ | ✓ | ✓ | ✓ | ✓ | ✓ | - | - |
| File Management | ✓ | ✓ | ✓ | ✓ | ✓ | ✓ | ✓ | ✓ | ✓ | - | - |
| Site Inventory | ✓ | ✓ | ✓ | ✓ | ✓ | ✓ | ✓ | ✓ | ✓ | - | - |
| Duplicate Application | ✓ | ✓ | ✓ | ✓ | ✓ | ✓ | ✓ | ✓ | ✓ | - | - |
| Customer Roles and Permissions | ✓ | ✓ | ✓ | ✓ | ✓ | ✓ | ✓ | ✓ | ✓ | - | - |
| Custom Summary Screens | ✓ | ✓ | ✓ | ✓ | ✓ | ✓ | ✓ | ✓ | ✓ | - | - |
| Ethernet, 3 Ports | ✓ | ✓ | ✓ | ✓ | ✓ | ✓ | ✓ | ✓ | ✓ | - | - |
| USB, 2 Ports | ✓ | ✓ | ✓ | ✓ | ✓ | ✓ | ✓ | ✓ | ✓ | - | - |
| SD, 1 Port, 1 GB Provided | ✓ | ✓ | ✓ | ✓ | ✓ | ✓ | ✓ | ✓ | ✓ | - | - |
| Site Aggregator | * | * | * | * | * | * | * | * | ✓ | - | - |
| Smart Alarms | * | * | * | * | * | * | * | * | ✓ | - | - |
| Performance Meter | * | * | * | * | * | * | * | * | ✓ | - | - |
| Floor Plan | ✓ | ✓ | ✓ | ✓ | ✓ | ✓ | ✓ | ✓ | ✓ | - | - |
| AHU Large | - | - | - | 6 | 8 | 6 | 8 | 9 | - | 8 | 0 |
| AHU Small | 4 | - | - | - | - | - | - | - | - | - | - |
| Analog Combiner | 64 | 128 | 128 | 128 | 128 | 128 | 128 | 130 | - | 128 | 128 |

Table 9-1 - Supervisory Controller Application and System Capacity Matrix

| Application | Supervisor Small Format SF | Refrigeration Supervisor RXS | Refrigeration Supervisor Expanded* RXe | Building Supervisor BXS | Building Supervisor Expanded* BXe | Combination Supervisor CXS | Combination Supervisor Expanded* CXe | Service Replacement SR | Site Aggregator SA | CO2-CXe | CO2- RXe |
|---------------------------------|----------------------------------|------------------------------------|--|-------------------------------|--|----------------------------------|--|------------------------------|--------------------------|---------|-------------|
| Analog Sensor Control | 12 | 64 | 72 | 64 | 72 | 24 | 48 | 80 | - | 72 | 72 |
| Anti-Sweat | 4 | 16 | 64 | 16 | 48 | 8 | 16 | 70 | - | 16 | 64 |
| Case Control Circuit | - | 48 | 64 | - | - | 12 | 24 | 70 | - | 24 | 64 |
| CO2 Suction Group | - | - | - | - | - | - | - | - | - | 3 | 3 |
| Condenser | - | 1 | 2 | - | - | 1 | 2 | 2 | - | 2 | 2 |
| CoreSense (Comm) | - | - | - | 31 | 31 | 31 | 31 | 40 | - | 2 | 2 |
| CoreSense Protection (Discus) | - | 63 | 63 | 63 | 63 | 63 | 63 | 70 | - | 99 | 99 |
| CoreSense (Large Ref Scroll) | - | 31 | 31 | - | - | - | - | - | - | 99 | 99 |
| CoreSense Diagnostics (ISD 2.0) | - | 31 | 31 | 31 | 31 | 31 | 31 | 40 | - | 99 | 99 |
| Control Link ACC | 8 | 63 | 63 | - | - | 16 | 16 | 70 | - | 16 | 63 |
| CT Drive | | 16 | 16 | 16 | 16 | 16 | 16 | 70 | - | 16 | 16 |
| Demand Control | 1 | - | - | 2 | 2 | 1 | 1 | 3 | - | 2 | 0 |
| Digital Combiner | 64 | 128 | 128 | 128 | 128 | 128 | 128 | 130 | - | 128 | 1128 |
| Digital Sensor Control | 12 | 64 | 72 | 64 | 72 | 24 | 48 | 80 | 5 | 64 | 72 |
| T-Stat | 8 | - | - | 32 | 64 | 32 | 64 | 70 | - | 64 | 0 |
| T-Stat Touchscreen | 8 | - | - | 32 | 64 | 32 | 64 | 70 | - | - | - |
| Energy Meter | 8 | 30 | 30 | 30 | 30 | 30 | 30 | 35 | - | 30 | 30 |
| Enhanced Suction Control** | - | 4 | 4 | - | - | 1 | 4 | 5 | - | - | - |
| Flexible Combiner | 64 | 128 | 128 | 128 | 128 | 128 | 128 | 130 | - | 128 | 128 |
| HVAC Zone | 4 | - | - | 32 | 40 | 6 | 12 | 45 | - | 12 | 0 |
| Irrigation | 2 | - | - | - | - | 2 | 2 | 3 | - | 2 | 0 |
| Lighting Control | 6 | - | - | 24 | 48 | 24 | 48 | 50 | - | 48 | 0 |
| Logging Group | 12 | 32 | 32 | 32 | 32 | 32 | 32 | 35 | - | 32 | 32 |
| Loop/Sequence Control | 8 | 16 | 24 | 16 | 28 | 16 | 28 | 30 | - | 28 | 16 |
| M400 | - | 16 | 16 | 16 | 16 | 16 | 16 | 70 | - | 16 | 16 |
| Modular Chiller Control | - | 1 | 2 | - | - | - | - | - | - | 0 | 2 |

Table 9-1 - Supervisory Controller Application and System Capacity Matrix

| Application | Supervisor Small Format SF | Refrigeration Supervisor RXS | Refrigeration Supervisor Expanded* RXe | Building Supervisor BXS | Building Supervisor Expanded* BXe | Combination Supervisor CXS | Combination Supervisor Expanded* CXe | Service Replacement SR | Site Aggregator SA | CO2-CXe | CO2-RXe |
|----------------------------|----------------------------|------------------------------|--|-------------------------|-----------------------------------|----------------------------|--------------------------------------|------------------------|--------------------|---------|---------|
| MRLDS | 24 | 24 | 24 | 24 | 24 | 24 | 24 | 30 | - | 24 | 24 |
| MRLDS-250 | 24 | 24 | 24 | 24 | 24 | 24 | 24 | 30 | - | 24 | 24 |
| MRLDS-450 | 24 | 24 | - | - | - | - | - | - | - | 16 | 16 |
| MultiFlex 16AI | 16 | 16 | 16 | 16 | 16 | 16 | 16 | 16 | - | 16 | 16 |
| MultiFlex 4AO | 2 | 16 | 16 | 16 | 16 | 16 | 16 | 16 | - | 16 | 16 |
| MultiFlex 8DO | 4 | 16 | 16 | 16 | 16 | 16 | 16 | 16 | - | 16 | 16 |
| MultiFlex 8DO | 16 | 32 | 32 | 32 | 32 | 32 | 32 | 32 | - | 16 | 16 |
| MultiFlex ARTC/RTU | - | - | - | 32 | 32 | 32 | 32 | 32 | - | 32 | 0 |
| MultiFlex ESR | - | 31 | 31 | - | - | 31 | 31 | 31 | - | 31 | 31 |
| MultiFlex RCB/RBC-P | - | - | - | 64 | - | 32 | 32 | 64 | - | 32 | 0 |
| MultiFlex CUB | - | 31 | 31 | - | - | - | - | - | - | 31 | 31 |
| RLDS | 1 | 16 | 16 | 16 | 16 | 16 | 16 | 20 | - | 31 | 31 |
| Standard Circuit | 6 | 48 | 64 | - | - | 12 | 32 | 70 | - | 16 | 16 |
| Standard Suction Control** | - | 4 | 4 | - | - | 1 | 4 | 5 | - | - | - |
| TD Condenser Fan Control | - | 64 | 64 | 16 | 28 | 16 | 28 | 70 | - | 28 | 64 |
| Time Schedule | 8 | 64 | 64 | 64 | 64 | 16 | 32 | 70 | - | 64 | 64 |
| Utility Monitoring | 8 | 16 | 16 | 32 | 64 | 8 | 16 | 35 | - | 64 | 64 |
| Wireless Gateway | 1 | 1 | 1 | 1 | 1 | 1 | 1 | 1 | - | 1 | 1 |
| Wireless Module | 99 | 99 | 99 | 99 | 99 | 99 | 99 | 99 | - | - | - |
| ECB-VAV | - | - | - | 25 | 25 | 25 | 25 | - | - | 25 | 0 |

Table 9-1 - Supervisory Controller Application and System Capacity Matrix

* License available.

** The number of suction groups indicated equals the total number of combined suction groups allowed. Both Enhanced and Standard suction groups combined cannot exceed this number.

** The number shown for Supervisory controllers indicates the total number of Suction Group applications available. A controller can support any combination of standard Suction Groups and Enhanced Suction Groups that do not exceed the total number for either type. For example, an RX supports two (2) Enhanced Suction Controls and two (2) Standard Suction Controls (a total of 4) or three (3) Enhanced Suction Controls and one (1) Standard Suction Control (a total of 4).

Supervisor I/O Network (RS-485)

Specified wiring: Belden #8761 (non-plenum), Belden #82761 and #88761 (plenum).

| Application | Supervisor Small Format SF | Refrigeration Supervisor RXS | Refrigeration Supervisor Expanded* RXe | Building Supervisor BXS | Building Supervisor Expanded* BXe | Combination Supervisor CXS | Combination Supervisor Expanded* CXe | Service Replacement SR |
|--------------------|----------------------------|------------------------------|--|-------------------------|-----------------------------------|----------------------------|--------------------------------------|------------------------|
| 4AO | 2 | 16 | 16 | 16 | 16 | 16 | 16 | 16 |
| 8RO | 16 | 32 | 32 | 32 | 32 | 32 | 32 | 32 |
| 8DO | 4 | 16 | 16 | 16 | 16 | 16 | 16 | 16 |
| 16AI | 16 | 16 | 16 | 16 | 16 | 16 | 16 | 16 |
| MultiFlex CUB | - | 31 | 31 | - | - | - | 31 | 31 |
| MultiFlex ESR | - | 31 | 31 | - | - | 31 | 31 | 31 |
| MultiFlex RCB | - | - | - | 64 | 64 | 32 | 64 | 64 |
| MultiFlex RTU/ARTC | - | - | - | 32 | 32 | 32 | 32 | 32 |

Table 9-2 - Supervisory Controller I/O Network RS-485

MODBUS Network (RS-485)

(Specified wiring: Belden 8641 (24 AWG, 300V, Part numbers 135-8641); Belden 8761 (22 AWG, 300 V, not stocked by Copeland; or a 600V-shielded 22 AWG equivalent, part number 135-0600) supporting a maximum cable distance of 4,000 ft (1,219 m) between the Supervisory controller and end-device. Belden 9855 may be used as an alternative in noisy environments, and is not recommended in other situations.

| Application | Supervisor Controller Small Format SF | Refrigeration Supervisor RXS | Refrigeration Supervisor Expanded* RXe | Building Supervisor BXS | Building Supervisor Expanded* BXe | Combination Supervisor CXS | Combination Supervisor Expanded* CXe | Service Replacement SR |
|---------------------------------|---------------------------------------|------------------------------|--|-------------------------|-----------------------------------|----------------------------|--------------------------------------|------------------------|
| Control Link® ACC | 8 | 63 | 63 | - | - | 16 | 16 | 70 |
| CT Drive | - | 16 | 16 | 16 | - | 16 | 16 | 20 |
| CoreSense (Comm) | - | 63 | 63 | 63 | 63 | 63 | 63 | 70 |
| CoreSense Protection (Discus) | - | 63 | 63 | 63 | 63 | 63 | 63 | 31 |
| CoreSense Large Ref Scroll (K5) | - | 31 | 31 | - | - | 31 | 31 | 31 |
| CoreSense Diagnostics (ISD 2.0) | - | 31 | 31 | 31 | 31 | 31 | 31 | 31 |
| Energy Meter | 8 | 30 | 30 | 30 | 30 | 30 | 30 | 40 |
| T-Stat (EOL) | 8 | - | - | 32 | 32 | 32 | 64 | 70 |
| DAC | - | - | - | 32 | 32 | 32 | 32 | 55 |
| RLDS | 1 | 16 | 16 | 16 | 16 | 16 | 16 | 20 |

Table 9-3 - MODBUS Network RS-485

| Application | Supervisor Controller Small Format SF | Refrigeration Supervisor RXS | Refrigeration Supervisor Expanded* RXe | Building Supervisor BXS | Building Supervisor Expanded* BXe | Combination Supervisor CXS | Combination Supervisor Expanded* CXe | Service Replacement SR |
|-------------------|---------------------------------------|------------------------------|--|-------------------------|-----------------------------------|----------------------------|--------------------------------------|------------------------|
| M400 | - | 16 | 16 | 16 | | 16 | 16 | 20 |
| MRLDS-250 | 24 | 24 | 24 | 24 | 24 | 24 | 24 | 30 |
| MRLDS-450 | 24 | 24 | 24 | 24 | 24 | 24 | 24 | 30 |
| Wireless Gateway | 1 | 1 | 1 | 1 | 1 | 1 | 1 | 1 |
| XR35_2.6, 5.6 | 32 | 99 | 99 | - | - | 99 | 99 | 99 |
| XR75_2.6, 5.6 | 32 | 99 | 99 | - | - | 99 | 99 | 99 |
| XR75_Case Display | 32 | 99 | 99 | - | - | 99 | 99 | 99 |
| XM670_3.4 | - | 99 | 99 | - | - | 99 | 99 | 99 |
| XM678_2.5, 2.8 | - | 99 | 99 | - | - | 99 | 99 | 99 |
| XM679_3.4, 4.2 | - | 99 | 99 | - | - | 99 | 99 | 99 |
| XEV22_1.1, 1.5 | - | 99 | 99 | - | - | 99 | 99 | 99 |
| XC645_2.5 | - | 99 | 99 | - | - | 99 | 99 | 99 |
| Condensing Units | 8 | 8 | 8 | 8 | 8 | 8 | 8 | 8 |

Table 9-3 - MODBUS Network RS-485

****Supervisory Controller supports four independent MODBUS networks – so the user can have multiple MODBUS addresses on the different networks. However, the total number of devices in both networks combined, cannot exceed 99.**

9.2 Site Aggregator Features

| Site Aggregator | |
|-------------------|---|
| ✓ | Brings together status and data from all Supervisors and E2's on site network |
| ✓ | Summary of all controllers in one view, Site Summaries, Custom Layouts |
| ✓ | Floorplans that combine data from all peer controllers into one view |
| ✓ | Navigate to any Supervisor controller on the peer network (box to box) |
| ✓ | Aggregate data from E2 peer network (sit on top, overlay E2s) |
| ✓ | Navigate to any E2 on the network through the Site Aggregator |
| Smart Alarm | |
| ✓ | User Friendly, Easy to Understand |
| ✓ | High Level Explanation |
| ✓ | Possible Causes |
| ✓ | Suggested Actions |
| ✓ | User Defined Messages |
| Performance Meter | |
| ✓ | Simple, intuitive way to recognize if performance is good or bad |
| ✓ | Quickly recognize worst performing cases or circuits |
| ✓ | Graph recent or historical performance |
| ✓ | Download performance data for analysis |
| ✓ | 13 months of performance history for seasonal comparison |
| Floor plans | |
| ✓ | Intuitive representation of store layout |
| ✓ | Quickly see your systems status in a way that makes logical sense |
| ✓ | Modern 2D or 3D store layout, systems, cases, and fixtures available |
| ✓ | Select Floor plan as home screen |
| ✓ | Load multiple Floor plans for different views |

Table 9-4 - Site Aggregator Features

*Feature licenses available in other models.

9.3 System Supervisor Features

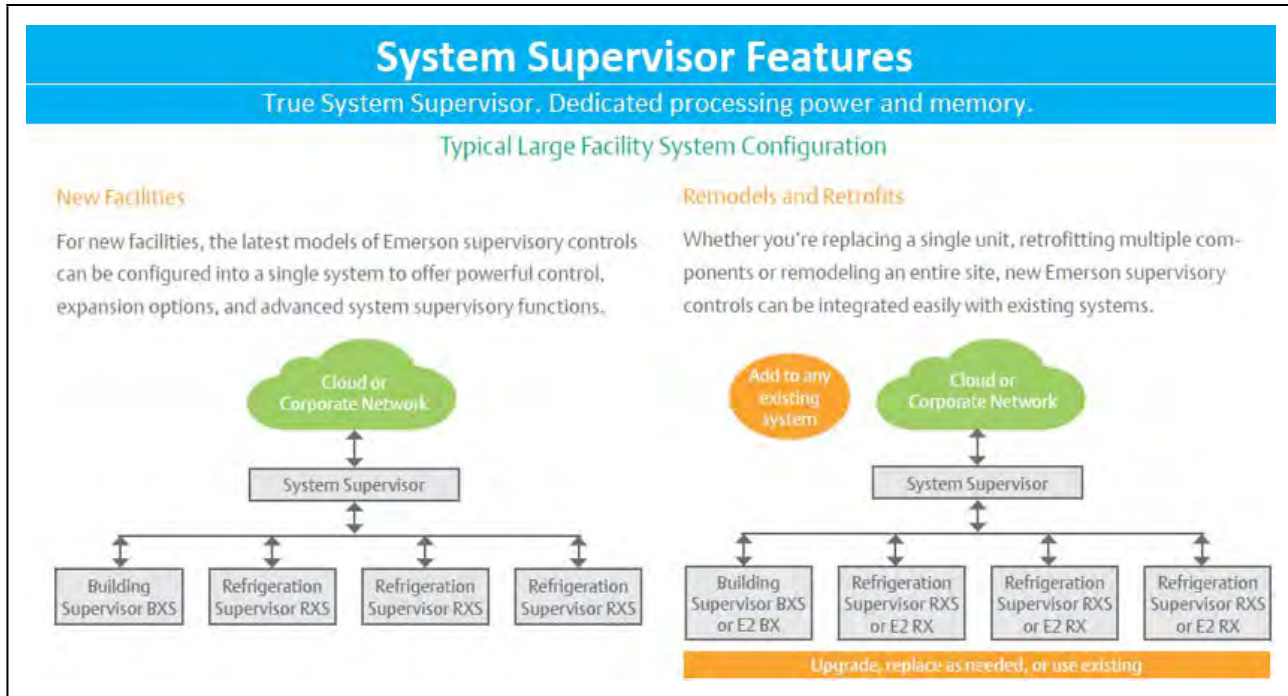

Figure 9-1 - Typical Large Facility System Configuration

9.4 Supervisory Controller Model Selection Guide

| Application | Supervisor Small Format SF | Refrigeration Supervisor RX | Refrigeration Supervisor Expanded* RX | Building Supervisor BX | Building Supervisor Expanded* BX | Combination Supervisor CX | Combination Supervisor Expanded* CX | Service Replacement SR | Site Aggregator SA |
|-----------------------------|----------------------------|-----------------------------|---------------------------------------|------------------------|----------------------------------|---------------------------|-------------------------------------|------------------------|--------------------|
| Supermarket | | | | | | | | | |
| Rack Control | | ✓ | ✓ | ✓ | ✓ | ✓ | ✓ | ✓ | ✓ |
| Condenser Control | | ✓ | ✓ | ✓ | ✓ | ✓ | ✓ | ✓ | ✓ |
| Refrigeration Case | ✓ | ✓ | ✓ | ✓ | ✓ | ✓ | ✓ | ✓ | ✓ |
| Convenience Store | | | | | | | | | |
| Lighting Management | ✓ | | | | | ✓ | ✓ | ✓ | ✓ |
| HVAC Systems | ✓ | | | | | ✓ | ✓ | ✓ | ✓ |
| Refrigeration Cases | ✓ | | | | | ✓ | ✓ | ✓ | ✓ |
| Energy Management | ✓ | | | | | ✓ | ✓ | ✓ | ✓ |
| Building Controls | | | | | | | | | |
| Lighting Management | ✓ | | | ✓ | ✓ | ✓ | ✓ | ✓ | ✓ |
| HVAC Systems | ✓ | | | ✓ | ✓ | ✓ | ✓ | ✓ | ✓ |
| Energy Management | ✓ | | | ✓ | ✓ | ✓ | ✓ | ✓ | ✓ |
| Add to Existing Site | | | | | | | | | |
| Overlay Existing E2 Network | | | | | | | | | ✓ |
| E2 Terminal Navigation | | | | | | | | | ✓ |
| Alarm Annunciator | | | | | | | | | ✓ |
| Email and Text Alarms | | | | | | | | | ✓ |
| Custom Graphic Screens | | | | | | | | | ✓ |
| Smart Alarm | | | | | | | | | ✓ |
| Performance Meter | | | | | | | | | ✓ |

Table 9-5 - Model Selection Guide

*Expansion Pack upgrade license available (i.e. upgrade RXS to RXSe equal to E2RX400). See E2 cross-reference guide for complete details.

| Model | Cross References |
|--------------------------|---|
| SF = Small Format | CX100 a flexible facility platform for small format retailers that simplifies control while giving retailers better control over their key store systems. |
| RX = Refrigeration | RX300 Primarily used in supermarket and commercial refrigeration applications. |
| RX = Refrigeration | RX400 Primarily used in supermarket and commercial refrigeration applications, more applications instances than the 300 |
| BX = Building | BX300 Primarily used in supermarket and commercial HVAC and lighting applications. |
| BX = Building | BX400 Primarily used in supermarket and commercial HVAC and lighting applications, more applications instances than the 300. |
| CX = Combination | CX300 Combination of the RX and BX controllers used for small to medium size Supermarkets, C-Store and QSR. |
| CX = Combination | CX400 Combination of the RX and BX controllers used for small to medium size supermarkets, C-stores and QSR. |
| SR = Service Replacement | New - Max number of applications, RX, BX, CX 400 level. |
| | Reduce complexity of carrying multiple types in the field for service calls. Save time when emergency replacement needed |
| SA = Supervisor | New - True Supervisor unit Aggregates all data into one view, Floorplans, with Smart Alarms and Performance Meter Logging. |
| | Enable aggregating of all data and status of all units at a site into one convenient view E2s and Supervisors. |
| | Compatible with E2s on peer network. Will overlay (sit on top) of E2s and provide terminal mode navigation to E2s. |

Table 9-6 - Supervisory Controller and E2 Cross-References

9.5 Supervisory Controller to E2 Cross-reference Guide

| Application | Small Format Controller SF | Refrigeration Controller RX | Refrigeration Controller RX | Building Supervisor BX | Building Controller BX | Combination Supervisor CX | Service Replacement SR | Site Aggregator SA |
|------------------------|----------------------------|-----------------------------|-----------------------------|------------------------|------------------------|---------------------------|------------------------|--------------------|
| RX300 | | ✓ | | | | | ✓ | |
| RX400 | | | ✓ | | | | ✓ | |
| BX300 | | | | ✓ | | | ✓ | |
| BX400 | | | | | | | ✓ | |
| CX100 | ✓ | | | | | | ✓ | |
| CX300 | | | | | | ✓ | ✓ | |
| CX400 | | | | | | ✓ | ✓ | |
| Aggregate Existing E2s | | | | | | | | ✓ |

Table 9-7 - Supervisory Controller to E2 Cross-References

*Expansion Pack upgrade license available (i.e. upgrade RXS to RXSe equal to E2RX400).

9.6 Supervisory Controller New Features

| Application | Small Format SF | Refrigeration Controller RX | Refrigeration Controller RX | Building Supervisor BX | Building Controller BX | Combination Controller CX | Combination Controller CX | Service Replacement SR | Site Aggregator SA |
|-----------------------------------|-----------------|-----------------------------|-----------------------------|------------------------|------------------------|---------------------------|---------------------------|------------------------|--------------------|
| New Intuitive Web UI | ✓ | ✓ | ✓ | ✓ | ✓ | ✓ | ✓ | ✓ | ✓ |
| Responsive Design | ✓ | ✓ | ✓ | ✓ | ✓ | ✓ | ✓ | ✓ | ✓ |
| Email and Text Alarms | ✓ | ✓ | ✓ | ✓ | ✓ | ✓ | ✓ | ✓ | ✓ |
| Graphical Defrost Summary | ✓ | ✓ | ✓ | ✓ | ✓ | ✓ | ✓ | ✓ | ✓ |
| File Management | ✓ | ✓ | ✓ | ✓ | ✓ | ✓ | ✓ | ✓ | ✓ |
| Site Inventory | ✓ | ✓ | ✓ | ✓ | ✓ | ✓ | ✓ | ✓ | ✓ |
| Duplicate Application | ✓ | ✓ | ✓ | ✓ | ✓ | ✓ | ✓ | ✓ | ✓ |
| Custom User Roles and Permissions | ✓ | ✓ | ✓ | ✓ | ✓ | ✓ | ✓ | ✓ | ✓ |
| Custom Summary Screens | ✓ | ✓ | ✓ | ✓ | ✓ | ✓ | ✓ | ✓ | ✓ |
| Ethernet, USB, SD Ports | ✓ | ✓ | ✓ | ✓ | ✓ | ✓ | ✓ | ✓ | ✓ |
| Site Aggregator | * | * | * | * | * | * | * | * | ✓ |
| Smart Alarms | * | * | * | * | * | * | * | * | ✓ |

Table 9-8 - Supervisory Controller New Features

| Application | Small Format SF | Refrigeration Controller RX | Refrigeration Controller RX | Building Supervisor BX | Building Controller BX | Combination Controller CX | Combination Controller CX | Service Replacement SR | Site Aggregator SA |
|------------------------------------|-----------------|-----------------------------|-----------------------------|------------------------|------------------------|---------------------------|---------------------------|------------------------|--------------------|
| Performance Meter | * | * | * | * | * | * | * | * | ✓ |
| Floor Plans | ✓ | ✓ | ✓ | ✓ | ✓ | ✓ | ✓ | ✓ | ✓ |
| Floor Plans with E2 Peer Network** | * | * | * | * | * | * | * | * | ✓ |

Table 9-8 - Supervisory Controller New Features

*Feature licenses available in other models

**See Aggregator features

9.7 Suction Groups

9.7.1 Introduction

The Supervisory Controller RX refrigeration controller uses suction group applications to cycle compressors in an effort to maintain a constant suction pressure or temperature in a refrigeration system. A suction group may contain up to 16 compressor stages (standard, variable-speed, or unloader).

There are two different types of suction group applications:

- Suction Group** - The “standard” suction group application that has existed since the first version of the Supervisory Controller firmware. The Suction Group uses PID Control and with proper optimization it can achieve very tight suction pressure or temperature control, but compressor cycling is not based on load analysis and can be inefficient, especially in larger racks. All versions of Supervisory Controller support the standard Suction Group application.
- Enhanced Suction Group** - Introduced in Site Supervisor version 2.30F01, the Enhanced Suction Group has all of the important features of the older Suction Group application, but instead of employing user-configured PID constants to optimize operation, the Enhanced Suction Group determines optimum control by “learning” the effect each compressor and circuit load has on the suction input. The Enhanced Suction Group is easier to configure and more conservative with compressor cycling than the standard Suction Group. In addition, the Enhanced Suction Group also supports use of the Copeland Digital Scroll and Copeland Digital Discus compressors.

9.7.2 The (Standard) Suction Group Application

9.7.2.1 Overview of PID Control Strategy

A Suction Group application looks at suction pressure or suction temperature to determine how many compressor stages should be ON or OFF. The application compares the suction pressure or temperature to its control setpoint using PID control. The result of this comparison is a percentage from 0% to 100% that corresponds to the total capacity of the compressor rack that should be active.

The Suction Group application then takes that percentage and determines what combination of compressors should be switched ON or OFF to best fulfill the requirement. For example, if the application says that 60% of the total compressor rack's power should be active, and the rack has compressors totaling 50 HP, then the supervisory controller will try to switch on compressors totaling 30 HP.

9.7.2.2 Variable-Speed Compressors

Suction Group applications are compatible with variable-speed compressors. VS compressors allow Suction Group applications to "fine-tune" the amount of total active rack horsepower to react to small changes in suction pressures or temperatures. As a result, the rack does a better job of controlling suction, requiring less compressor switches.

When a variable-speed compressor is present, it will generally be treated as the primary pressure controlling device, and any other standard compressors in the rack are secondary devices used only if the VS compressor is unable to fully handle the required horsepower. The variable-speed compressor will be the first compressor on and the last compressor off.

9.7.2.3 Floating Setpoint Control

The Floating Setpoint strategy within the supervisory controller RX provides a method for varying the suction setpoint of the group based on the temperature within a circuit. When Floating Setpoint Control is enabled, the Supervisory Controller RX monitors either a circuit temperature or a case temperature from a CC-100 and adjusts the suction setpoint if the temperature is too low or too high.

The user establishes a range outside of which the Supervisory Controller RX is instructed to make a one PSI adjustment to the suction pressure setpoint to either reduce or increase the case temperature. If the temperature continues to remain outside of the range for a user-defined period of time, the Supervisory Controller RX continues to make pressure setpoint adjustments until the temperature is within the established range.

By varying the suction pressure setpoint to match the temperature requirements of the circuit, the Supervisory Controller RX is able to ensure product integrity while achieving maximum rack efficiency.

9.7.3 The Enhanced Suction Group Application

A Suction Group application looks at suction pressure or suction temperature and compares it to the suction setpoint to determine whether compressor stages should be cycled ON or OFF. Unlike the Suction Group application, which uses a PID percentage to determine how many stages to turn ON or OFF, the Enhanced Suction Group keeps historical data of the effects each compressor stage has on the suction pressure or temperature, and analyzes that data to determine which stages to cycle.

The Enhanced Suction Group application is designed to balance tight control of suction pressure with economic management of compressor cycling to reduce power usage and compressor wear.

9.7.3.1 Learning Mode

When an Enhanced Suction Group application runs for the first time, it undergoes a "Learning Mode" period to collect data on the compressor stages. During Learning Mode, the Enhanced Suction Group will control suction pressure, but it will purposely cycle the compressor stages in different combinations to measure the effect they have on the suction input value.

The Learning Mode lasts for several minutes. After Learning Mode ends, the Enhanced Suction Group will require up to 24 hours of operation before compressor cycling is operating at maximum efficiency. If compressor cycling seems too frequent after 24 hours of operation, you may reduce compressor cycling by changing the Control/Cycles parameter (see **Section 9.7.3.3, The Control/Cycles Parameter**).

9.7.3.2 Circuit Load Analysis

Unlike the standard Suction Group algorithm, the Enhanced Suction Group includes Circuit Setup where you associate all circuits connected to the suction group. Once the circuits are set up, the suction group will use the circuit states to help determine current loads on the suction group. For example, when one or more circuits go into defrost, the Enhanced Suction Group determines that there is less of a load on the suction group than if all circuits were in refrigeration. With the appropriate circuits associated, the Enhanced Suction Group tailors its capacity to meet the load. Over time, the Enhanced Suction Group will build and store a profile for all the different combinations of circuit states encountered in the algorithm.

9.7.3.3 The Control/Cycles Parameter

Unlike the standard Suction Group, which used PID constants as a means of optimizing suction control and had limited features for controlling compressor cycle counts, the Enhanced Suction Group has one parameter with five preset settings to allow users to alter suction control performance or compressor cycling frequency.

The default setting, "Moderate Control," seeks to balance good suction pressure control with efficient cycling. If tighter control is needed, setting the field to "Tight Control" or "Tightest Control" will increase the application's reaction to suction changes, resulting in tighter control (usually at the expense of more frequent cycling). If fewer compressor cycles are desired, setting the field to "Less Cycling" or "Least Cycling" will decrease the number of cycles but also increase the amount of fluctuation in the suction pressure.

9.7.3.4 Variable-Speed, Digital Scroll, and Digital Discus Compressor Support

The Enhanced Suction Group supports variable-speed compressors similar to the Suction Group application. When a variable-speed compressor is present, it is the first compressor stage ON and the last stage OFF, and its capacity is varied to attempt to correct small fluctuations in the suction pressure or temperature.

In addition, the Enhanced Suction Group application supports use of one or multiple Copeland Digital Scroll or Digital Discus compressors for use as a variable-capacity compressor. With several Digital Scroll or Digital Discus compressors, the Enhanced Suction Group will modulate one of those compressors at a time to control suction

pressure. As compressor capacity is added or removed, the Enhanced Suction Group may modulate another Digital Scroll compressor to distribute compressor resources and solenoid wear.

The operating capacities of the Copeland Digital Scroll and Copeland Digital Discus compressors are determined in the same way as a variable-speed compressor, except the Copeland Digital Scroll and Copeland Digital Discus controlled by pulse-width modulation (PWM).

9.7.3.5 Floating Suction Control

Floating suction control in the Enhanced Suction Group behaves identically to the way it works in the Suction Group application. Refer to **Section 9.7.2.3, Floating Setpoint Control**.

9.7.4 Hardware Overview

An overview of the input and output devices that make up a Suction Group is shown in **Figure 9-2**. These devices should be wired to input and output boards in

the manner outlined in **Table 9-9** and **Table 9-10**.

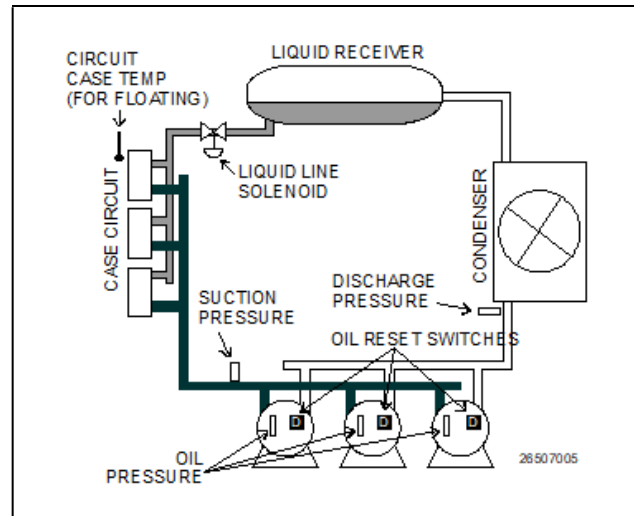

Figure 9-2 - Diagram of a Suction Group

| Input | Sensor Type | Wiring Instructions |
|--------------------------|----------------------------|-----------------------------|
| Suction Pressure | 100 lb. Eclipse transducer | (see Table 9-1 on page 9-1) |
| Discharge Pressure | 500 lb. Eclipse transducer | (see Table 9-1 on page 9-1) |
| Oil Pressure | 200 lb. Eclipse transducer | (see Table 9-1 on page 9-1) |
| Case Circuit Temperature | Temperature | (see Table 9-1 on page 9-1) |
| Oil Reset Switches | Digital | (see Table 9-1 on page 9-1) |

Table 9-9 - Suction Group Inputs

| Output Device | Wire Output Board Contacts to: | Set Failsafe Dip Switch to: | Notes |
|----------------------------|--------------------------------|-----------------------------|--|
| Compressor | N.C. | N.C. (up) | If you want a compressor to be OFF during network/power loss, use N.O. fail-safes instead. |
| Unloader | N.C. | N.O. (down) | These fail-safe settings are specifically for unloaders. |
| Liquid Line Solenoid (LLS) | N.C. | N.C. (up) | Keeps solenoid energized during network/power loss. |
| Electric Defrost | N.O. | N.O. (down) | Keeps contacts de-energized during network/power loss. |

Table 9-10 - Suction Group Outputs

9.8 Suction Float

The Floating Setpoint strategy within the Supervisor provides a method for varying the suction setpoint of the group based on the temperature within a circuit. When Floating Setpoint Control is enabled, the Supervisor monitors either a circuit temperature or a case temperature and adjusts the suction setpoint if the temperature is too low or too high. The user establishes a range outside of which the Supervisor is instructed to make a one PSI adjustment to the suction pressure setpoint to either reduce or increase the case temperature. If the temperature continues to remain outside of the range for a user-defined period of time, the Supervisor continues to make pressure setpoint adjustments until the temperature is within the established range. By varying the suction pressure setpoint to match the temperature requirements of the circuit, the Supervisor is able to ensure product integrity while achieving maximum rack efficiency.

9.9 Analog Sensor Control

The Analog Sensor Control reads the values from one or more analog sensors, compares them to a set of Cut In/Cut Out setpoints, and operates a digital output (such as a relay) based on the analog input in relation to the setpoints.

An Analog Sensor Control module performs three functions:

- **COMBINER** - Up to four analog inputs are combined into a single analog value.
- **CUT IN/CUT OUT CONTROL** - The combined input value is compared to a Cut In/Cut Out setpoint. Based on this comparison, a digital output will be turned ON or OFF.
- **ALARMING** - Alarms and notices can be generated based on the combined value of the inputs and its relation to a set of high and low alarm and notice setpoints.

9.9.1 Control Strategy

The application combines multiple analog inputs into a single output, using either the primary combination method or the alternate combination mode, depending on the state of the Use Alternate Combination property.

The primary and alternate combination methods may be configured to be one of the following:

- Average - of all defined inputs
- Minimum value
- Maximum value
- First - first input value that is not NONE
- Mix of first two inputs (using mix ratio property)
- Span - difference between the highest and lowest input values (multiple inputs)
- Select - single value chosen by the input select (if input select is 5, use in5)
- Sum - sum all inputs
- $(in1 + in2) + in3$
- $(in1 - in2) - in3$
- $(in1 * in2) * in3$
- $(in1 + in2) / in3$
- $(in1 * in2) + in3$
- $(in1 - in2) * in3F$
- $|in1 - in2| / in3$
- $|in1 - in2| * in3$
- $\text{sqr}(|in1 - in2|) * in3$

The combined values can be filtered. The filter's primary function is to slow the rate of change of the combined input. The difference between the current input value and the input's value x seconds ago, where $x = \text{Factor Time}$, is multiplied by the filter ratio to produce the filter output.

The filtered output is run through a CutIn / CutOut calg that trips a digital output (Command Out) based on the CutIn / CutOut setpoints.

There is also a counter on the Command Out that provides a running count that increase every time the Command Out cycles to ON and a digital Counter Trip Output that is ON when the Counter value is greater than the Counter's trip point. The user enters the initial value and the count increases by the Count Inc value. The Count output value is reset by sending a signal to the Reset Count input. The Count Reset Type parameter specifies whether the Count is reset based on the logic level, the rising edge or the falling edge. The counter increase based on the digital output after the bypass block.

The PRI DEMAND SHED and SEC DEMAND SHED inputs provide a way to have the cell shut down in demand shed situations. If the PRI DEMAND SHED is ON, the Cut In/Cut Out setpoints is bumped by the amount set in the Pri Demand Bump parameter. Likewise, for the SEC DEMAND SHED except the primary demand shed has priority if they are both ON. The Stpt Bump Rst Int indicates the amount of time over which the setpoint is ramped back to normal.

9.9.2 Control Alarming

There is a high and low limit alarm and notice for the inputs after they are combined and filtered. The user sets occupied and unoccupied, high and low setpoints. If the combined/filtered value exceeds either the notice or alarm setpoints, a notice or alarm is generated. If the Alarm Disable or Notice Disable input is high, the Alarm or Notice output, respectively, is forced to OFF. There are Notice and Alarm digital outputs that the user can connect to. In addition, the alarm and notice is automatically sent to AdvisoryServices.

9.9.3 Alarm Output When On/Off Parameters

Alarm When On redefines the definition of "active" as it refers to the state of the Alarm output. When the Sensor Control application calls for the Alarm output to be ON the Alarm output will change to the state specified in the Alarm When On field. Select either ON, OFF, or NotAct in this field. Alarm When Off redefines the definition of "inactive" as it refers to the state of the Alarm output. When the Sensor Control application calls for the Alarm output to be OFF, the Alarm output will change to the state specified in the Alarm When Off field. Select either OFF, ON, or NotAct in this field.

9.9.4 Control Bypass

The digital output may be bypassed with a timed bypass. The output may be bypassed to ON, OFF or NONE. Once the STRT TIMED BYP goes high, the bypass remains in effect until the Bypass Time has expired. The CNCL TIMED BYP will cancel any bypass and operation will return to normal. If STRT TIMED BYP is still on, it must go low for one update before it will activate another bypass.

9.10 Digital Sensor Control

The Digital Sensor Control read the values from one or more digital sensors, combine them using a series of logical commands, and operate a digital output (such as a relay) based on the result of the logical combination.

The Digital Sensor Control module performs three basic functions:

- LOGICAL COMBINATION - up to four inputs may be combined using standard logical combination methods (such as AND, OR, XOR). The result is the command output value, which can be used to operate a relay.
- BYPASS - The command output may be configured to be bypassed to a fixed value by a switch or button press.
- ALARMING - Alarms and notices can be generated based on the command value of all the digital inputs of the cell, plus occupancy, and schedules.

9.10.1 Control Strategy

The Digital Output Module cell provides a mechanism for combining multiple Digital Outputs into a single output that can be used as an input to other cells.

The inputs can be combined as the following:

- AND - logical AND of inputs
- OR - logical OR of inputs
- XOR - logical XOR of inputs
- VOTE - result will be ON if the number of inputs ON > number of inputs OFF
- FIRST - returns the logical value of the first good (non-DV_NONE) input. There is also a First Good output which shows the number 1-4 of the first good input.

The Digital Output Module allows for a user to specify two different input combination strategies: a primary combination type, and an alternate combination type. The module reads the state of the Use Alternate Combination method input to determine which combination method to use.

The combined value is then sent to a Schedule Interface strategy. The Schedule Interface strategy allows the user to modify the combined value based upon the occupied or unoccupied state of the system. Two different combination strategies may be specified by the user; a primary combination strategy and an alternate combination strategy. When the Use Alt Shed input is LOW, the primary combination is used. When the Use Alt Shed input is HIGH, the alternate combination strategy is used.

The output is then sent to a Min On/Min Off property that sets its output based on the Min On/Min Off delay times.

The resulting output is passed to a One-Shot calculation for applications that require a pulse rather than a logic level. The output of the One-Shot can be a pulse of length Pulse Width seconds that starts when the input to the One-Shot rises or falls depending on the Timer Type selection.

The Proof Fail output will be active as a result of comparing the final control value with the Proof input. If the input and output do not match for a length of time equal to the Proof Delay, the Proof Fail output will go to ON. It will stay ON for at least Proof Latch Dur seconds. The user can select to use the actual value from the Command output or the output from the Min On/Min Off property. The proof will generate an alarm if the Proof Alarm Type property is not set to Disabled.

There is also a counter on the Command Out that provides a running count that increments every time the Command Out cycles to ON and a digital Counter Trip Output that is ON when the Counter value is greater than the Counter's trip point. The user enters the initial value and the count increments by the Count Inc value. The Count output value is reset by sending a signal to the Reset Count input. The Count Reset Type parameter specifies whether the Count is reset based on the logic level, the rising edge or the falling edge. The counter increments based on the digital output after the bypass block.

The PRI DEMAND SHED input provides a way to have the cell shut down in demand shed situations. If the PRI DEMAND SHED is ON, the output will be set to the logical OFF position by using the bypass functionality. The Cmd When Off param will set the proper off value for the output. The counter will not increment when in demand shed regardless of the inputs.

9.10.2 Command Alarming

The command value will be used to determine the alarm state. The command value is the combined value of all the digital inputs of the cell, plus occupancy, and schedules.

When the command value changes to alarm condition, the delay timer will start. If the state changes, the timer will stop and no alarm will be issued. If the state stays for the duration of the timer, an advisory will be issued. If a state change occurs to the opposite state after the advisory has been issued, it will be returned to normal.

If the advisory is reset, and the alarm/notice condition still exists, the delay period will be honored. Advisories will return to normal if the command value stays in the non-alarm/notice condition for the duration of the clear delay. If the command value changes back to the alarm condition, during the clear timer, the advisory will not return to normal.

9.10.3 Alarm Output When On/Off Parameters

Alarm When On redefines the definition of the command "ON" as it relates to the state of the command output. When the Sensor Control application calls for the output to be "ON," the command output will switch to the state selected in the Cmd When On parameter. Select either ON, OFF, or NotAct in this field.

9.10.4 Control Bypass

The digital output may be bypassed with a timed bypass. The output may be bypassed to ON, OFF or NONE. Once the STRT TIMED BYP goes high, the bypass remains in effect until the Bypass Time has expired. The CNCL TIMED BYP will cancel any bypass and operation will return to normal. If STRT TIMED BYP is still on, it must go low for one update before it will activate another bypass.

9.11 Lighting Control

The Lighting Control application controls indoor and outdoor lights. The number of Lighting Applications allowed is based on the total number of applications allowed in the controller. Additional applications (more than 24) may be added with a separate license key.



Push Button Override

A push button override will override the store lighting to ON if the light level drops due to low light level conditions when the lights are not already ON. A digital input sees the signal when the button is pressed for two seconds. When the digital input is activated and points to the push button, the output will turn the lights ON. A timer counts how long the light will stay on. If the timer is set for two hours, the lights will stay in override for two hours after the override push button is pushed.

9.11.1 Lighting Control Logic

The user can specify the combination of inputs required to turn the lights on and a different combination of inputs to turn the lights off. The four inputs that may be combined are:

1. **Digital Input** - The digital input includes: Light Level Sensor Input, Logic Input, Schedule Input and Solar Input.
2. **Light Level Sensor** - If Light Level and Solar are used together, Light level sensor checking will be enabled if light level proof is enabled. If the Light Level Sensor and Solar Calculation do not match for a user-specified time delay, an alarm will be generated. This alarm will be submitted to the alarm subsystem. The text of the alarm will be "Light Level Sensor - Possible Failure".

3. **Schedule** - The controller's Lighting Application will not provide an internal schedule capability. An external time schedule application is required to control the lighting output based on a schedule.
4. **Solar (Sunrise/Sunset)** - If Light Level and Solar are used together, Light Level sensor checking will be enabled if Light Level Proof is enabled. If the Light Level Sensor and Solar Calculation do not match for a user-specified time delay, an alarm will be generated. This alarm will be submitted to the alarm subsystem. The text of the alarm will be "Light Level Sensor - Possible Failure".

The following parameters are provided by the application to configure the logic for turning the light output on or off.

- Input 1 - Chooses the type of input value that is used as the first value in the logical equation. Choose Logic, Sched, Llev, or Solar.
- Logic 1 - Chooses the method of combining Input Source 1 with Input Source 2 (AND or OR). If you are only using one Input Source for this equation, leave the Logic 1 field blank.
- Input 2 - Choose the type of input value that is used as the second value in the logical equation. Choose Logic, Sched, Llev, or Solar.
- Logic 2 - Chooses the method of combining the result of the Input 1 and Input 2 combination with Input Source 3 (AND or OR). If you are only using two Input Sources for this equation, leave the Logic 2 field blank.
- Input 3 - Chooses the type of input value that will be used as the third value in the logical equation. Choose Logic, Sched, Llev, or Solar.
- Logic 3 - Chooses the method of combining the result of the Input 1, 2, and 3 combination with Input Source 4 (AND or OR). If you are only using three Input Sources for this equation, leave the Logic 3 field blank.
- Input 4 - Chooses the type of input value that is used as the fourth value in the logical equation. Choose Logic, Sched, Llev, or Solar.

9.11.2 Light Level Sensor Verification

If Light Level and Solar are used together Light Level sensor checking is enabled if light level proof is enabled. If the Light Level Sensor and Solar Calculation do not match for a user-specified time delay, an alarm is generated. This alarm is submitted to the alarm subsystem.

The text of the alarm is "Light Level Sensor - Possible Failure".

9.11.3 Solar Calculation

The Sundown input tells the Lighting Control application when sundown begins and ends (ON when sunset occurs, and OFF at sunrise). It is automatically tied to the SUNDOWN output of the Time and Date cell, and should not be redefined if you plan on using solar calculations for this Lighting Control application.

To set up the solar cell calculation (sunrise/sundown), this can be configured in the Global Data application.

In Global Data, the Lighting application automatically receives the information when the sun sets.

9.11.4 Digital Lighting Output

The application supports a digital lighting output. The state of this output is determined based on the outcome of the lighting control method that is selected.

9.11.5 Light Proofing

Light output proofing is supported by the application.

The following parameters are provided by the application to configure proofing:

- Proof Type - Determines what light state(s) the application will use proof checking for in the Proof Type field.

There are three options:

- ▶ ALL Values - Proof checking verifies the lights come ON when called to be ON and OFF when called to be OFF.
- ▶ ON Values - Proof checking verifies only that the lights have turned ON when called to be ON.
- ▶ OFF Values - Proof checking verifies only that the lights have turned OFF when called to be OFF.
- PROOF IN - Proof input.
- Proof Delay - When the Lighting Control application detects a proof failure, it waits for the Proof Delay time period to pass before turning on the Proof Status output. If during this delay the proof input returns to normal, the delay is canceled and the Proof Status output remains OK.

- Proof Latch - Once the Proof logic has recorded a proof failure and the Proof Status output has transitioned to FAIL, the output remains in FAIL until the control input has been equal to the proof input for an amount of time equal to the Proof Latch delay. If during this delay the proof fails again, the delay is canceled and the output remains in FAIL.
- Clear Any Match - Enter YES to clear the proof on any match. If a proof failure should be cleared whenever a match of any kind is made between the proof input and the light state, set this to 'Yes.' If the proof failure is to be cleared only when a match of the type listed in the Proof Type field is made, set this to "No."

9.11.6 Minimum On/Off Times

The application supports minimum on and off times for the digital lighting output.

The following user parameters are provided to configure the minimum on/off times and the on/off delays for the lighting output.

- Min ON Time - The least amount of time the command value must remain ON before the Min On/Off logic allows a transition to OFF. If the command value has not been ON for at least this value, the Min On/Off logic replaces the command value with an ON signal until the Minimum ON time has been met.
- Min OFF Time - The least amount of time the command value must remain OFF before the Min On/Off logic allows a transition to ON. If the command value has not been OFF for at least this value, the Min On/Off logic replaces the command value with an OFF signal until the Minimum OFF time has been met.
- ON Delay - delay between ON cmd and turning lights ON. When the Min On/Off logic detects a transition in the command value from OFF to ON, it waits for the ON delay period to pass before switching its output ON. If during this delay the command value switches OFF again, the delay is canceled and the lighting output remains OFF.
- OFF Delay - delay between OFF cmd and turning lights OFF. When the Min On/Off logic detects a transition in the command value from ON to OFF, it waits for the OFF delay period to pass before switching its output OFF. If during this delay the command value switches ON again, the delay is canceled and the lighting output remains ON.

9.11.7 Dimming Control (Analog Output)

The application supports a dimming (analog) lighting output. This output is intended to be used to control a dimming module by specifying the percentage of maximum output of the connected dimming module.

In dimming mode, dimming is controlled on the Light Level sensor input to the application. If there is no Light Level sensor or it reads NONE, the lights are forced to default brightness (specified by the "Dim Fail %" parameter).

As the Light Level changes, the output ramps at a user defined rate. The minimum % output corresponds to maximum Light Level input. Anything above the maximum Light Level results in the minimum % output. The maximum % output corresponds to a minimum Light Level input. Anything below the minimum Light Level input results in the maximum % output.

The ramp is defined in terms of Light Level per second. The ramp is linear between the minimum % output and the maximum % output. The bypass dimming percentage input forces the dimming percentage when in bypass operation.

Theory of Operation

As the Light Level input increases above minimum light level, the Light Level analog output begins ramping to accommodate. As the Light Level input increases above the maximum light level but below the cut off light level, the Light Level analog output ramps to the minimum percentage. As the Light Level input increases above the cut off Light Level, the ramped analog output is minimum, and the minimum on time has been satisfied, the cut off delay begins counting down.

If the light level continues above the cut off light level for the duration of the cut off delay timeout, the lights output goes OFF. If the light level dims to below the cut on light level, the light's output turns ON. The Light Level analog output will ramp to the appropriate percentage for that light level.

The following parameters are provided to allow configuration of the light dimming output.



NOTE: For the properties below, Light Level Engineering Units should be displayed as fc (foot candle).

- CUTOFF - Normal light level cut OFF setpoint.
- UNOCC CUTOFF - Unoccupied light level cut OFF setpoint
- UNOCC CUTON - Unoccupied light level cut ON setpoint.
- LLEV OCCUP - Occupancy input for light level setpoints
- Cut ON Delay - Light Level cut ON delay.
- Cut OFF - Light Level cut OFF delay.
- Cut ON Dly UNOC - Light Level cut ON delay [unoccupied].
- Cut OFF Dly UNO - Light Level cut OFF delay [unoccupied].
- LIGHT LEVEL IN - Light Level sensor input. The LIGHT LEVEL IN input, which is the input to which the Light Level sensor is connected, is by default connected to Global Data's LIGHT LEVEL OUT output. If there is no Supervisory Controller on the network with a Light Level sensor connected to Global Data, it will need to be set up.
- En Llev Proof - Enables light level proofing to SUNDOWN input. The Enable Light Level Proofing field enables or disables a feature in Lighting Control that allows failures to be detected in the Light Level sensor if the sensor does not fall below the cutoff setpoint after sundown, or rise above the cut on setpoint after sunset. If "Yes" is selected, the Llev Pr Delay parameter specifies the time to wait before alarming if the above conditions are not satisfied.
- Llev Pr Delay - Light level proofing alarm delay. The Light Level Proof Delay is the amount of time after sunrise or sunset that, if the light level sensor does not cut ON or OFF appropriate to the light level of a sunrise or sunset, generates an alarm. In other words, if the Light Level Proof Delay is set for 1 hour, the light level must fall below the cut-off setpoint at least one hour after sundown, or an alarm is generated. Likewise, if the cut-on Light Level setpoint is not reached by at least one hour after sunrise, an alarm is generated.

- Dim Upper % - Upper dimmer percentage.
- Dim LL @ Upper% - Light level at upper dimmer percentage.
- Dim Lower % - Lower dimmer percentage.
- Dim LL @ Lower% - Light level at lower dimmer percentage.
- Dim Ramp Speed - Ramp speed in percent per minute.
- Dim Fail % - Percentage when light level sensor fails.
- Dim Shed % - Percentage when a demand shed event is present.

9.11.8 External Schedule

An input is provided to allow a time schedule application to be connected to the Lighting Application.

9.11.9 Lighting Bypass Inputs

The application provides two bypass inputs:

- Bypass ON - When ON, this input will force the digital lighting output ON.
- Bypass OFF - When ON, this input will force the digital lighting output OFF.

9.11.10 Demand Shed Behavior

The application provides a demand shed input. When this input is ON, the Lighting Application turns the lighting output OFF. Generally, this input is connected to the Demand Control application.

If the lighting application is configured to use dimming, the lighting output is set to the "Dim Shed %" value while a shed event is active.

9.12 Global Data

The Global Data application is the central location for commonly used data values and limited data calculations such as degree days and seasonal determination.

The following are the global data outputs:

- SUMMER WINTER - Summer/Winter indication output.
- COOLING DEGREE DAY - Indicates the current cooling degree day calculation based on the "integration" method. The calculation starts over at midnight for the new day and the previous day's calculation is logged.

- HEATING DEGREE DAY - Indicates the current heating degree day calculation based on the "integration" method. The calculation starts over at midnight for the new day and the previous day's calculation is logged.
- ENTHALPHY DEGREE DAY - Indicates the current enthalpy day calculation based on the "integration" method. The calculation starts over at midnight for the new day and the previous day's calculation is logged.
- DAY SCHED OUT - Indicates current day of week or holiday.

The Global Data function allows property information to be shared in a mixed site that contains both E2 and E2 Enhanced Controllers and Supervisory Controllers.

9.12.1 Location From

Sunrise and sunset times are calculated based on either zip code or latitude/longitude. If US Zip Code is chosen in the Unit Location From field, enter the zip code in which the controller is located. If outside the United States, choose Lat/Long and enter the latitude and longitude values in which the controller is located. Once a value has been chosen, the controller is able to calculate the sunrise and sunset times. The Sunset output will turn ON at sunset, and OFF at sunrise and can be connected to a lighting circuit.

9.12.2 Sundown

Sundown is an output that calculates when the sun sets based on latitude and longitude, and is ON when the sun sets. (When a Lighting Schedule is configured to use Sundown information, the Lighting Schedule application automatically connects to the Sundown output).

9.13 HVAC Control

The HVAC control application controls HVAC equipment, rooftop units, or air handlers.

The number of AHU applications allowed is based on the total number of applications allowed on the device. The AHU application provides basic functionality to control a typical packaged HVAC unit. The packaged HVAC units have up to four stages of heating and cooling and may have a fresh air damper installed to allow free-air cooling (economization) when conditions permit.



NOTE: The AHU application provides support for Constant Air Volume (CAV) systems only. The Variable Air Volume (VAV) systems are not supported.

9.13.1 Active Setpoint Determination

The active setpoint used by the heating and cooling logic is selected from the following setpoint inputs:

- SUMMER HEAT OCC - This field is the setpoint that is used for heating control during summer occupied mode. If this AHU has been assigned to a Zone application, this input is automatically be defined so that the Zone application supplies the setpoint value. You do not need to change this definition.
- SUMMER HEAT UOC - This field is the setpoint that is used for heating control during Summer Unoccupied mode. If this AHU has been assigned to a Zone application, this input is automatically defined so that the Zone application supplies the setpoint value. You do not need to change this definition.
- SUMMER COOL OCC - This field is the setpoint that is used for cooling control during Summer Occupied mode. If this AHU has been assigned to a Zone application, this input is automatically defined so that the Zone application supplies the setpoint value. You do not need to change this definition.
- SUMMER COOL UOC - This field is the setpoint that is used for cooling control during Summer Unoccupied mode. If this AHU has been assigned to a Zone application, this input is automatically defined so that the Zone application supplies the setpoint value. You do not need to change this definition.
- WINTER HEAT OCC - This field is the setpoint that is used for heating control during Winter Occupied mode. If this AHU has been assigned to a Zone application, this input is automatically defined so that the Zone application supplies the setpoint value. You do not need to change this definition.
- WINTER HEAT UOC - This field is the setpoint that is used for heating control during Winter Unoccupied mode. If this AHU has been assigned to a Zone application, this input is automatically defined so that the Zone application supplies the setpoint value. You do not need to change this definition.
- WINTER COOL OCC - This field is the setpoint that is used for cooling control during Winter Occupied mode. If this AHU has been assigned to a Zone application, this input is automatically defined so that the Zone application supplies the setpoint value. You do not need to change this definition.
- WINTER COOL UOC - This field is the setpoint that is used for cooling control during Winter Unoccupied mode. Enter the desired setpoint value in this field. If this AHU has been assigned to a Zone application, this input is automatically defined so that the Zone application supplies the setpoint value. You do not need to change this definition.



NOTE: The active setpoint chosen from the above list is based on the current occupancy status, the season (Summer/Winter), and whether the AHU is in heating or cooling mode. If the AHU is neither heating nor cooling, the last mode used will determine the active setpoint.

9.13.2 Setpoint Reset

The active setpoint may be changed by a Reset Sensor input. A Reset Sensor is used to allow reset on the setpoint based on an external sensor, such as humidity or outside temperature. The user selects an input range for the sensor and a maximum offset. The offset value is calculated proportional to the output range while the input value is calculated proportional to the input range.

9.13.3 Demand Shed

The active setpoint may be changed by the primary or secondary demand shed inputs. If either demand shed is active (ON), the active setpoint is adjusted by the amount specified by the demand bump parameters.

Control Temperature Determination

The AHU determines which sensor should be used to provide overall control to the space being conditioned, for example, the control temperature. The control temperature can be a single space temperature, a combination of two space temperatures, or the return air temperature.

The Controlled By parameter specifies which sensor is used as the control temperature.



NOTE: Either Space or Return may be selected.

The Num Space Temps parameter specifies the number of space temperature inputs that will be used. Note that either one or two may be selected.

The Temp Comb Meth parameter specifies how two space temperature sensors are combined. The possible selections are:

- Average - The control temperature is the average value of all sensors.
- Min - The lowest temperature value is used as the control value.
- Max - The highest temperature value is used as the control value.

9.13.4 Heating and Cooling Control

The AHU application supports up to four stages of heating and four stages of cooling. Additionally, the application supports up to two heat pump stages.

9.13.5 Control Logic

The application will control heat and cool stages using a T-Stat strategy. This strategy utilizes a deadband to determine when heating or cooling stages should be switched on or off.

Deadband

T-Stat Deadband specifies the range of temperatures around the heat and cool setpoints within which the temperature is considered acceptable. When the control temperature is between the current setpoint plus 1/2 the T-Stat Deadband and the current setpoint minus 1/2 the T-Stat Deadband, the AHU will keep all stages in their current states and will not activate or deactivate any stages.

Multiple Stage Support

Multiple Stage Support is activated based on a stage delay in conjunction with the T-Stat Deadband parameter when multiple heating or cooling stages are defined.

The Two Delay Parameters are the Following:

- **Cool Stage Delay** - The delay between cool stage activations or deactivations. After a cool stage is activated, the AHU waits an amount of time equal to the Cool Stage Delay. If the temperature is still above the cool setpoint (plus one-half the deadband) it activates the next stage of cooling. Similarly, after a cool stage is deactivated, the AHU waits until the Cool Stage Delay has elapsed, and if the temperature is still below setpoint (minus one-half the deadband) it deactivates the next cool stage.
- **Heat Stage Delay** - The delay between heat stage activations or deactivations. After a heat stage is activated, the AHU waits an amount of time equal to the Heat Stage Delay. If the temperature is still below the heat setpoint (minus one-half the deadband) it activates the next stage of heating. Similarly, after a stage is deactivated, the AHU waits until the Heat Stage Delay has elapsed, and if the temperature is still above setpoint (plus one-half the deadband) it deactivates the next heat stage.

9.13.6 Heat/Cool Lockout Based on Outside Air Temperature

The heating and cooling functions can be disabled if the outside air temperature is outside of a specified range.

Cooling can be configured for OAT lockout by setting the "Cool Lockout En" parameter to Yes. When enabled, if the outside air temperature falls below the value specified by "COOL OAT LO, C", all cooling functions are disabled. When the outside air temperature rises above this setpoint, cooling is enabled.

Heating can be configured for OAT lockout by setting the "Heat Lockout En" parameter to Yes. When enabled, if the outside air temperature rises above the value specified by "HEAT OAT LOC", all heating functions are disabled. When the outside air temperature falls below this setpoint, heating is enabled.

9.13.7 System Shutdown

If the SHUTDOWN input is turned ON, the application goes into a shutdown mode that immediately turns off any heating or cooling stages presently on. The heating and cooling stages remain OFF as long as the SHUTDOWN input is ON.

9.13.8 Fan Control

The AHU application supports a single-speed indoor fan.



NOTE: The variable speed fan support may be incorporated into this application in a later phase of the product.

9.13.9 Fan Mode

The fan can be designated as Continuous, Auto, or Summer On/Winter Auto. There are separate fan mode settings for occupied heating, unoccupied heating, occupied cooling and unoccupied cooling. When the fan mode is set to "Auto", the fan only turns on if there is an active stage of heating/cooling or if economization is enabled. When the fan mode is set to "Continuous", the fan runs continuously in the selected heating or cooling mode, regardless of whether any stages of heating or cooling are currently active. When the fan mode is set to "Sum ON/Win Auto", the fan runs continuously during the summer season, and runs in Auto mode during the winter season.

9.13.10 Plenum Warmup/Purge

The application supports a plenum warmup/cooldown delay on startup and a purge delay when turning off. There are separate delays for both heating and cooling modes, and these are only used when the fan is in Auto mode. The warmup/cooldown delays allow the plenum to reach a target temperature before turning on the fan to prevent undesirable supply air from reaching the building occupants. The purge delays are used to extract the remaining heat/cold from the plenum after the heating/cooling has turned off.

9.13.11 Fan Proof Failure

When Fan Prf Fail En is enabled and a fan proof failure is detected, heating and cooling loads are shut down until the proof failure goes away or the fan proof alarm is reset or cleared. If the fan is configured to shut down on a fan proof failure, the system is restarted by setting the FAN FAIL RST input to ON or clearing the fan proof failure from the advisory log.

9.13.12 System Shutdown

If the SHUTDOWN input is turned ON, the application goes into a shutdown mode that turns off the fan. The fan remains OFF as long as the SHUTDOWN input is ON.

9.13.13 Economization (Damper) Control

HVAC economizers can save energy in buildings by using cool outside air as source of cooling the indoor space. When the temperature of the outside air is less than the temperature of the re-circulated air, conditioning the outside air is more energy efficient than conditioning re-circulated air. When the outside air is both sufficiently cool and sufficiently dry (depending on the climate), the amount of enthalpy in the air is acceptable and no additional conditioning of it is needed; this portion of the air-side economizer control scheme is called free cooling.

The AHU economizer control operation depends on whether a two-position or variable position damper control is used. The user may also select "None" as the economizer damper type if no economization is desired.

The Two Basic Operations of the Economizer Algorithm are Divided into:

1. Determine if economization should occur:
 - Is the outdoor air suitable for economizing?
 - Is the AHU in heat mode?
 - Is there a failure in the AHU?
 - Does the control temperature require cooling from economization?
 - Is the supply temperature too low?
2. Determine the analog damper position:

Steps to Determine if Economization Should Activate

The algorithm begins with determining whether economization should occur. This is determined by five inputs:

1. Is the outdoor air suitable for economizing?
2. Is the AHU in heat mode?
3. Is there a failure in the AHU?
4. Does the control temperature require cooling from economization?
5. Is the supply temperature too low?

Outdoor Air Suitability

The economizer outdoor air suitability algorithm determines whether outdoor air conditions are suitable for the algorithm to enable economization. The result of the algorithm is an "Econ OK" signal. The suitability is determined by comparing the outdoor air temperature to the control temperature. If the outside air temperature is cooler, then the Econ OK signal is set to ON.

In addition to the outdoor air temperature, there is a user-defined maximum outdoor air humidity setpoint (Max OA Hum) above which outdoor air is not used for economization. In this case, the Econ OK signal is set to OFF.

Heat Mode

If the AHU is in heating mode, economization is disabled. Economization is a cooling function and would therefore be counterproductive to heating.

Failure Lockout

If the AHU application has detected a failure, economization is disabled. Failures that can lock out economization are:

- Fan Proof Fail - When fan proof failure is detected, heating and cooling loads are shut down until the proof failure goes away or the fan proof alarm is reset or cleared. If the fan is configured to shut down on a fan proof failure, the system is restarted by setting the FAN FAIL RST input to ON or clearing the fan proof failure from the advisory log.
- SHUTDOWN input is ON - The application goes into a shutdown mode that turns off the fan. The fan remains OFF as long as the SHUTDOWN input is ON.

Control Temperature above Economization Setpoint

If the control temperature is greater than the occupied cooling setpoint minus the occupied economization delta, then economization is permitted. If the control temperature is greater than the unoccupied cooling setpoint minus the unoccupied economization delta, then economization is permitted. If either the control temperature or the setpoint minus the economization delta has a value of NONE, then economization is not permitted.

Low Supply Temp Lockout

If the supply temperature is below "Econ Lock Temp", the economizer is disabled.

9.13.14 Determine the Analog Damper Position

The analog damper position is determined by using a PID loop. The output is based on the mixed air temperature compared to the occupied or unoccupied mixed air setpoint ("Occ CL Mix Temp" or "Unoc CL Mix Tmp"). The output is limited to the occupied or unoccupied minimum damper position. If the economization is inactive, the analog damper is set to the occupied or unoccupied minimum damper position, based on the current occupancy state. If the economization is active, the output from the Economizer PID loop is written to the analog damper output.

9.13.15 Determine the Digital Damper Position

The digital damper output turns ON when economization is active.

9.13.16 Heat Pump Control

If any heat pump stages are defined, they activate in parallel with the first cooling and heating stages defined. For example, if one heat pump stage and one heat stage are defined, when a call for heat occurs, the heat pump stage is considered stage one and it turns on along with the heat stage (HEAT STAGE 1). If a second stage of heat is required, two heat stages should be defined. Likewise, for cooling, if one heat pump stage and one standard cooling stage are defined, and a call for cooling occurs, the heat pump stage is considered cool stage one and it turns on along with the COOL STAGE 1 output. If a second stage of cooling is required (not a heat pump stage), two cool stages should be defined.

9.13.17 Reversing Valve

The reversing valve must be identified as either a heating or cooling reversing valve by setting the "Reversing Valve" parameter. When the reversing valve is set to cooling, the reversing valve turns on when a call for cooling is active and turns off when a call for heating is active. Likewise, when the reversing valve is set to heating, the reversing valve turns on when a call for heating is active and turns off when a call for cooling is active. Once the call for heating or cooling is no longer active, the reversing valve remains in its last known state. When the AHU application is reset, the reversing valve output initializes the OFF state.

9.13.18 Compressor Output

When either a call for heating or cooling is active, the compressor output for the called stage turns on. When the heating or cooling call is no longer active, the compressor turns off.

Control Temperature

A control temperature advisory occurs after a user-specified time delay for both high and low temperature conditions. This advisory must have associated parameters to allow the user to specify the high and low advisory value and the delay, and must be separate setpoints for occupied and unoccupied mode.

Supply Fan Proof Failure

A supply fan proof failure advisory is generated when the AHU is calling for the supply fan to be ON and the fan status input indicates the fan is not operating. This advisory should have an associated parameter to allow the user to enable or disable the advisory and a parameter to specify the time delay before the advisory is activated.

9.13.19 Curtailment

To set up curtailment in the system software, the user must designate which specific heating and cooling stages is subject to curtailment. When the power company sends a curtail command (for example, the value of the curtailment device switches to "CLOSED"), all stages that are set up to be curtailed is shut off and locked out.



NOTE: Fan control is not directly affected by a call for curtailment.

9.14 Time Schedule Application

The Time Schedule application schedules lighting or occupancy state activities. The allowed number of Time Schedule Applications is based on the total number of applications allowed in the controller. Support for additional applications may be added with a separate license key.

9.14.1 Time Schedule Method

The Time Schedule application is enabled when the ENABLE input is ON. The schedule feeds its time schedule output and acts as an independent schedule.

The Time Schedule Types are:

Standard Schedule

The user defines a "Standard Schedule" that specifies the ON/OFF times for each day of the week, and the ON/OFF times for the holidays/special days.

For the schedule, the ON/OFF times are absolute times.

For the Standard Schedules the user may specify the date range that the schedule is active. This allows the user to have multiple schedules based on the time of year.

Master Schedule

The Master Schedule feeds its time schedule output to the Slave Schedule(s) or acts as an independent schedule.

Slave Schedule

The user defines a "Standard Schedule" that specifies the ON/OFF times for each day of the week, and the ON/OFF times for the holidays/special days. These ON/OFF times have different implications depending on whether the schedule is a master or slave type.

The Slave Schedule needs a Master Schedule as one of its inputs. Provides offset capability to the Master's events. The user defines a "Standard Schedule" that specifies the ON/OFF times for each day of the week, and the ON/OFF times for the holidays/special days. These ON/OFF times have different implications depending on whether the schedule is a master or slave type.

For Slave Schedules, the ON/OFF times are either absolute times or relative times to the Master Schedule, in which positive time represents how much time after and negative time represents how much time ahead of what is specified in the Master Schedule. There can be at most one relative ON time and one relative OFF time for a single day. For the Master Schedule, the ON/OFF times are absolute times.

For the Standard Schedules the user may specify the date range that the schedule is active. This allows the user to have multiple schedules based on the time of year. The schedules can be combined using a combiner application.



NOTE: The Schedule time ranges can be modified by dragging the schedule bar to adjust time.

Schedules (Master Slave) are now easier and flexible to create during setup. The system can now show all created schedules in the summary screen (master and slave schedules).

9.14.2 Standard Schedule

Each standard schedule is made up of up to 15 daily event schedules. Each daily event schedule is made up of two times (typically an On/Off pair). For each daily event schedule the user can assign which days of the week that daily schedule should be used (seven days plus four holiday/special days). This allows a unique daily schedule for each day of the week or one where it is followed multiple days during the week. If a user needs more than two On/Off events in one day, they can combine multiple daily schedules together (they still are limited to 15 daily event schedules per overall schedule).

9.14.3 Event Names

The user can assign an event name on each event. By default the name of the event is Event x, where x is the event number (1-15).

9.14.4 Maintenance Schedule

A user can define three maintenance schedule changes for each time schedule.

The following information is included:

- **START DATE** - The start date at which the Time Schedule will start ignoring its standard events and following its maintenance overrides.
- **START TIME** - The start time at which the Time Schedule will stop following its standard events and start using its maintenance overrides. If you want the maintenance override to be followed for the entire day, leave this field set to 0:00 and the End Time to 23:59.



NOTE: The Start Time is not the time you wish for the maintenance override to make a state transition - it is the time when you want to start the schedule override.

- **END DATE** - the date the maintenance override should end in this field. If the maintenance override is only going to last one day, enter the same date in this field as is in the Start Date.
- **END TIME** - the end time at which the Time Schedule will stop following the maintenance override and start using its standard events. If you want the maintenance override to be followed for the entire day, leave this field set to 23:59 and the Start Time to 0:00.

Note that the End Time is not the time you wish for the Time Schedule to make a state transition, it is the time when you want to end the schedule override.

- **ON EVENT TIME** - The time of day you wish the schedule output to be ON when the Time Schedule application is following this maintenance override.
- **OFF EVENT TIME** - The time of day you wish the schedule output to be OFF when the Time Schedule application is following this maintenance override.

Once the maintenance schedule is complete (moved past the END DATE), the schedule application returns to following its standard schedule. Maintenance Schedule is active for the entire day and for all days between (and including) the START DATE and END DATE.

9.14.5 Maintenance Overrides

Maintenance overrides are set up through Time Scheduling. Time Schedules are used for timed activation and deactivation of loads and for providing occupied and unoccupied building times for occupancy-driven systems (such as Sensor Control, Lighting, and HVAC).

There are four different types of schedules used:

- Master schedules are the main scheduling unit. A master schedule consists of up to 15 scheduled ON/OFF event pairs, which may be programmed to occur on any individual date and time or series of dates and times. Master schedules may also drive slave schedules.
- Slave schedules are similar to master schedules, except their operation is driven by a master schedule. Slave schedules, generally, are alterations of the master schedule's event times. The ON/OFF times in a slave schedule may take place either at specific defined times of the day or relative to the times given in the master schedule. For example, a master schedule may say: "The building is occupied from 8:00 a.m. to 9:00 p.m.," while one of its slave schedules says "Dim the building lights 15 minutes before the store closes." Slave schedules may also be mastered by other slave schedules to create a series of stacked schedules.
- Holiday schedules are used to tell master and slave schedules that a special day or event is occurring. For example, master schedules and their corresponding slave schedules may be programmed with special holiday events, such as "Keep all lights off during Holiday x." The holiday schedule's job is to inform the schedules to which it is connected, "Today is Holiday x." Although holiday schedules are used exclusively by Time Scheduling applications, they are set up as individual applications separate from Time Scheduling.
- Maintenance schedules are not schedules but Maintenance Override functions that may be made to exist within an individual master or slave schedule. Maintenance schedules are used to override the ON/OFF instructions of an individual master or slave schedule temporarily. Generally, maintenance schedules are only used for one-shot applications, such as keeping the lights on an extra hour for a single night. Maintenance schedules override all other events within a master or slave schedule, including holidays.

How Schedules Work Events

Master schedules and slave schedules consist of up to 15 pairs of events. Events are simple commands to turn the schedule output either ON or OFF at a particular time within a range of days. Events are usually programmed in pairs, so that during a specified range of days the schedule output can be turned ON and OFF at a particular time within the same day. However, events may be programmed singularly (one OFF or one ON command per day). Events may be programmed to take place on any or all days from Sunday to Saturday. In addition, events may take place on any or all of four holiday (or "special") dates, called HD1, HD2, HD3, and HD4. Holiday schedules are used to tell the master or slave schedules when these special dates occur.

Absolute and Relative Events

Master schedule events always occur at specific times of the day. In other words, when you program an event pair in a master schedule, you must specify two specific times of the day the events will occur. These types of events are called absolute events.

However, when programming event times in slave schedules, you may choose to enter event times that are relative to its master schedule's ON and OFF times. These types of events are called relative events. They are programmed not as absolute times but as amounts of time before or after its master schedule's events.

For example, suppose a master schedule is set up to be ON at 8 a.m. and OFF at 9 p.m. every day of the week, and you wish to set up a slave schedule so that its output comes ON 15 minutes before the master comes ON and OFF 15 minutes after the master goes OFF. To do this, you would set up the slave schedule to come ON at -00:15 and OFF at +00:15 every day of the week. The slave schedule will automatically determine the correct ON and OFF times.

Maintenance Schedule Events

Each schedule may also be given up to three pairs of maintenance schedule events. These events start and end at specific days and times and do not continue past those dates (in other words, maintenance events cannot be made to occur weekly or annually).

Overlapping

Events may, and often do overlap within a schedule. When events overlap, the Supervisory Controller uses the following priority structure, from highest to lowest:

1. Maintenance Schedule Event #1
2. Maintenance Schedule Event #2
3. Maintenance Schedule Event #3
4. Events that occur on HD1 (Holiday #1)
5. Events that occur on HD2 (Holiday #2)
6. Events that occur on HD3 (Holiday #3)
7. Events that occur on HD4 (Holiday #4)
8. Maintenance Schedule Events of a slave schedule's master schedule (if applicable).
9. Standard events within the schedule itself.

Ranges

In addition to the 15 events within a master or slave schedule, up to 12 standard ranges may be specified. Ranges are sets of dates that specify which days within the year the schedule's events will be applied. The Site Supervisor checks the list of ranges to see if the current date falls within any of the twelve possibilities; if the date does not fall within a range, none of the schedule's events will occur.

When no date ranges are specified, the schedule is considered to be active. All scheduled events will occur normally.

Holiday Schedules

A Holiday Schedule application's primary function is to pass along the day of the week to one or more master or slave schedules, and to tell these schedules when it is a holiday

(HD1 - HD4). A holiday schedule determines holidays by cross-referencing the current date with its user-programmed list of holiday date ranges. During the time periods of these date ranges, the holiday schedule tells the schedules to perform the events programmed for one of the four holiday dates (HD1, HD2, HD3, or HD4).

Because multiple Supervisory Controllers on a network would likely use the same holiday schedules for determining special occupied and unoccupied building hours, holiday scheduling is handled by Global Data. This means the holiday schedule can be set up in one Supervisory Controller and shared with all other Supervisory Controllers that use time scheduling.

9.14.6 Output Calculation

The Time Schedule control algorithm calculates the current On/Off status, the time until change of state (TUCOS) and time since change of state (TSCOS) for all the schedules. This information is available for the other applications that are making use of a particular schedule. The schedules output status reflects the results of any bypass or override, but there is also an output that reflects the actual calculated value based on the time of day.

The Time Schedule control algorithm runs every minute to determine the state of the schedule, but a new bypass request or a new demand shed request is processed immediately. A termination of a bypass or a demand shed request is also processed immediately. The Time Scheduling control algorithm is composed of a core scheduling algorithm, bypass, override, and demand control handling.

There may be outputs that the Time Schedule does control directly and in these cases the user is able to enable demand shedding of the output. If the Demand Control Input indicates shed and if the schedule output is On, it is turned Off. The load is turned back On at the next minute advance when the Demand Control Input indicates restore.

9.14.7 Scheduling Logic

The core scheduling algorithm determines the state of the active schedule. It does not take bypass, override, and demand shed inputs into account. The core scheduling algorithm operates under two different modes: either Master or Slave as determined by the "Schedule Type" input. The difference among these two operation modes is the different usage of some inputs/ outputs and their corresponding values.

Schedule Priority

The schedule used is based on the following priority scheme and within the following categories.

- Maintenance Schedule - If any of the maintenance schedules are active, (in the Master Schedule) that maintenance schedule is used as the current schedule. Time until next change of state and time since previous change of state will be given in minutes.
- Holiday/Special Schedule - The DAY SCHED input provides which day of the week or holiday schedule to follow. When DAY SCHED input indicates that a holiday is active, all schedules follow the selected holiday schedule. If a holiday is entered and a schedule does not have the selected special daily schedule defined, then it reverts back and use the regular schedule for that day of the week.

- Standard Weekly Schedule - If a daily schedule is not defined for a day of the week then the control algorithm searches back in time for the last defined state change. If no daily schedules are defined, the output of the schedule is set to Off.

Overlapping Events

The user is allowed to enter overlapping events, however, the first ON event and first OFF event of out-of-sequence events is picked up.

Operation When Not Within Programmed Date Range

If the current system date does not fall into any of the date ranges specified, the schedule control loop is considered not active. A special value (NO_VALUE) is written to the output, and TUCOS is set to a maximum TUCOS value (2 days or 2880 minutes) while TSCOS still reflects the actual elapsed time since last change of state.

The Master Schedule

If a daily schedule is not defined for a day of the week, the control algorithm searches back in time for the last defined state change. If no daily schedules are defined, the output of the schedule is set to OFF. The DAY SCHED input provides which day of the week or holiday schedule to follow. When DAY SCHED input indicates that a holiday is active, all schedules follow the selected holiday schedule. If a holiday is entered and a schedule does not have the selected special daily schedule defined, then it reverts back and uses the regular schedule for that day of the week.

If any of the maintenance schedules are activated, that maintenance time schedule shall be used as the current schedule. Time until next change of state and time since previous change of state will be given in minutes. During bypass, override, or demand control, TUCOS output is set to maximum TUCOS value and TSCOS reflects the actual time since change of state.

9.14.8 Control Override

When the EMERGENCY input is active, the normal control algorithm is overridden and CONTROL OUT is immediately forced to the value specified by the EMERGENCY OUT parameter.

Slave Schedule

The ON/OFF times of the schedules (except for maintenance schedules) can either be absolute or relative. When the times are relative to the corresponding Master events, positive time represents how much time after the Master event and negative time represents how much time ahead of the Master event. There is at most one relative time for either ON time or OFF time for a single day.

The following illustrates the Master Schedule DAY SCHED Output with the Slave schedule behavior:

- Maintenance Schedule - follow the Master's maintenance schedule. Normal day of week schedules are ignored even if they are active.
- Holiday Schedule/Normal Day of Week - if Maintenance Schedule is active, run a Maintenance Schedule. A relative event time of the corresponding schedule is used to modify the master's schedule while the absolute event times take precedence over the Master's events.
- Bypass, Override, or Demand Shed active (TUCOS=MAX_TUCOS) - events with negative relative times start immediately. If the delay (as indicated by positive relative time of Slave's event) is longer than the duration of the Master's special event, the Slave does not react to that Master's special event.

9.14.9 Control Bypass

When the BYPASS TO ON input is active, the control output is forced to the ON state regardless of normal schedules. Likewise, when BYPASS TO OFF is active, control is forced to the OFF state. BYPASS TO ON has the higher priority over BYPASS TO OFF.

9.14.10 Control Override

When the EMERGENCY input is active, the normal control algorithm is overridden and CONTROL OUT is immediately forced to the value specified by the EMERGENCY OUT parameter.

9.14.11 Special Conditions

- Cold Reset - When the application has a Cold Reset request, the OUTPUT will be set to NO_VALUE.
- Warm Reset - When the application restarts from a power outage or something else, a Warm Reset is requested. The control loop scans back to find out the last event before the current time.
- Uninitialized Inputs - If a NO_VALUE appears on DAY SCHED input, the control's OUTPUT falls back to the normal day of the week. If a NO_VALUE appears on any other input, the input value is forced to a predetermined (hard coded) default value and the control algorithm continues to operate normally.

- Failed Inputs - If a failure is detected on the DAY SCHED input, the control's OUTPUT falls back to the normal day of the week. If a failure is detected on any other input, the input value is forced to a predetermined (hard coded) default value and the control algorithm continues to operate normally.

9.14.12 Priority of Services

The application prioritizes its activities such as:

1. ENABLE input - The Enable input determines whether the schedule will be enabled (ON) or disabled (OFF). When disabled, all the schedule's outputs, are set to NONE. If this input is not defined, the controller assumes it to be ON.
2. EMERG OVERRIDE - The Emergency Override input allows the user to override the schedule Output to a fixed digital value. When ON, the schedule overrides the Output to the value specified in the Emergency Out field.
3. BYPASS - When the Bypass to ON input is ON, the schedule ignores its own scheduled events and bypasses the schedule output ON. When the Bypass to OFF input is ON, the schedule ignores its own scheduled events and bypasses the schedule output OFF. If both Bypass to ON and Bypass to OFF are ON at the same time, Bypass to ON takes priority over Bypass to OFF.
4. DEMAND SHED - If this input is turned ON it will turn the output of the Time Schedule to the OFF (unoccupied) state. This input is used for demand shedding in Power Monitoring and Demand Control applications, and typically it is only used when the schedule output is directly controlling a load (lights, fans, and more).
5. Standard scheduling activities - The user defines a "Standard Schedule" that specifies the ON/OFF times for each day of the week, and the ON/OFF times for the holidays/special days.

9.14.13 Control Alarming

There are no alarms associated with Time Scheduling Control.

9.14.14 Schedule Category

The Time Schedule application provides a category for the user to specify how the time schedule application is used.

9.15 Demand Control

The Demand Control application monitors power demand on a metered system (for example, main panel, sub panel, or unitary equipment and shed configured loads) in response to high demand situations in the controller.



NOTE: There is a single licensed Demand Control application in the controller. Additional Demand Control applications can be added with a separate license key.

9.15.1 KWH Calculation

The controller has the ability to calculate energy consumption based on:

- Analog KW Input (Analog KW signal) - When an analog KW input is selected, the application calculates the energy consumption on an hourly, daily, and monthly basis by integrating the instantaneous power samples (approximation by finite steps). The application can take into account a varying sampling frequency of the input signal to produce an energy calculation.
- Digital Energy Pulse Input (Digital KWh pulse input) - When a digital energy pulse input is selected, the application calculates energy consumption on an hourly, daily, and monthly basis by accumulating the energy pulses detected on the digital input. The digital input is able to support energy pulse rates up to 50 pulses per second.

Also, an instantaneous power (KW) output is calculated. This calculation uses the energy consumed over a one minute period to calculate the average power over the minute period.

9.15.2 Demand Calculation

Average KW (Demand) Calculation

The power company's peak demand charge is an average KW value over an interval window. This interval is usually in the 15 to 30 minute range, but can be as short as five minutes. Some pulse meters provided by the power company provides a signal that determines when a new demand interval is starting. In general the control strategy cannot count on this signal being available. Therefore, the demand control window used by the application must be set to the same value as the power company's demand window.

Load Shedding Activation

The application integrates the power level above and below the setpoint on a rolling demand window of the same length as the utility demand window. That way, if the average KW in the rolling window is kept below the setpoint, the electric utility never detect a demand usage exceeding the setpoint.

Once the KW input rises above the setpoint, levels start to shed.

The amount shed depends on several factors:

- If the integral error is approaching zero, the amount shed is the KW input minus the setpoint.
- If the KW input has been continuously above the setpoint for 1/4th of the demand window and the KW input is not going down, shed two levels at a time.
- Shed one level at a time. If the KW input goes below the setpoint, it starts to shed one level at a time.

If the KW input goes below the setpoint minus the hysteresis and the integral error is less than zero, the levels start to restore. They continue to restore until the KW input goes above the setpoint.

Demand Setpoint Determination

The demand setpoint is determined based on the current season - Summer or Winter. For each season, there are two setpoints available. The active setpoint is chosen based on the state of a setpoint switch input. In this way, different demand setpoints may be selected depending on the time of day or some other signal.

9.15.3 Shed Outputs

There are up to 60 shed requests for a system. These shed requests are placed into three categories.

During the configuration of the various control applications, a user assigns a particular shed request to any of the following control loop:

- First Shed - Loads assigned to First Shed Requests are shed first when the demand goes above setpoint and are the last loads to be restored. They are shed sequentially in assigned order.
- Rotational Shed - Loads assigned to Rotational Shed Requests are shed in a rotational scheme after the First Shed loads are shed. On each new demand condition the next rotational load in the sequence is shed first. This is done so that the DLC burden is shared equally.

- Last Shed - Loads assigned to Last Shed Requests are only shed once the First Shed and all available Rotational loads are shed. They are shed sequentially in assigned order. These loads are the first loads to be restored.

When a level is shed, the shed timer is started and the staging interval timer (minimum time to wait before shedding the next load) is set to the value programmed for this shed level.

The shed sequence depends on the type of loads that are available to be shed. Loads assigned as first shed are always the first shed in the user assigned sequence. Once all the first shed loads are shed, the rotational loads are shed. Assigning a load to be a rotational scheme is done to balance the burden of demand shedding among all the loads. This means that the application will not shed the same load until all other rotational loads are shed. After all available rotational loads are shed, the last shed loads are shed in the user assigned sequence.

The loads are restored based on the following rules:

- Last shed loads are restored first in a last shed first restore order.
- Rotational loads are restored based on which one are shed the longest.
- First shed loads are restored in a last shed first restore order.
- After a load is restored, the staging interval timer is set (set to the same value used when this load is shed). Once the staging interval expires the next load is restored if the power level is still below the setpoint minus the deadband.
- If a load is restored due to maximum shed time-out that counts for the restored load for that application update interval.

There are several factors that affect the order of how the loads are shed and restored:

- Minimum shed time - the minimum time that a shed load must stay in shed
- Minimum restore time - the minimum time that a shed load must stay in restore (not shed)
- Maximum shed time - the maximum time that a shed load may remain actively shed

Another load is not shed to replace a load that is restored due to the maximum shed time expiring unless the power level is still above setpoint.

If a shed level is in restore mode but its minimum restore time is not met, levels in the next higher category will not be shed. For instance, if all the first sheds are shed and one of the first sheds times out due to max shed time, rotate and last shed loads will not continue to shed until all first shed loads are shed again.

Multiple loads can be assigned to each shed level, but a user should assign the same KW to each shed level. The KW assigned to a shed level is used by the application in determining how many shed requests should be shed at one time. However, since the application doesn't know the On/Off status of the loads assigned to a shed level and since the total KW that can be shed is usually only a portion of the total electrical power used, the application cannot accurately predict the actual results of a shed request. To compensate for this, the application assumes only 75% of the reported load being On. Additionally, the application is always taking immediate action when the power level is exceeding the KW Demand setpoint and it can bring the power level under control without a new demand level being recorded by the power company.

9.15.4 Application Alarms

The Demand Control an application provides application alarm to signal a high demand. The demand alarm limit and alarm delay should be configurable.

9.15.5 KW Load Specification

The application allows the user to specify the KW rating for each load connected to the Demand Control application. The application uses this information to help determine how many loads to shed at one time to prevent exceeding the demand setpoint.

9.15.6 Performance Requirements

KWH Pulse Input

1. When configured for KWH pulse input, the Demand Control application must detect 100% of all pulses present on the input, as long as the pulses occur no faster than 50 pulses/second (PPS) and have pulse width of at least 20ms.
2. The local digital inputs on the controller are able to support 50 PPS. Digital inputs located on expansion modules (such as IPX60) do not support KWH pulse inputs.

9.16 Utility Monitoring

The Utility Monitoring application tracks the consumption of metered services (such as electricity, gas, or water) and monitors the consumption in four separate time intervals: Daily, Weekly, Monthly, and a user defined interval.

The number of Utility Monitoring applications allowed is based on the total number of applications allowed in the controller. Additional applications may be added with a separate license key.

9.16.1 Utility Usage Calculation

9.16.1.1 Utility Type

The user can specify the type of utility to monitor by selecting either Electricity, Gas, or Water via the Usage Type parameter. The appropriate engineering units will be automatically configured based on this selection. For example, if Water is selected, the rate outputs (Present and Average) will be shown in the active user's selected water rate units, such as Liters/Min or Gallon/Min. Also, the periodic totalizer outputs will be shown in the active user's selected water volume units, such as Liters or Gallons. Likewise, if Electricity is selected, the Present and Average outputs will be shown in power units such as kW or watts and the periodic totalizer outputs will be shown in the energy units of kWh or watt-hours. The default units shown are dependent on the location settings configured on the controller.

9.16.1.2 Electrical Usage

If Electricity is selected as the Usage Type, the electrical input signal must be specified using the Electr Inp Type parameter. The selections available are kW analog, kWh pulse, Current, and Current 3-phase.



NOTE: The Electr Inp Type parameter only applies if the Usage Type is set to Electricity.

kW Analog Input

When Electr Inp Type is set to kW Analog, the Utility Monitoring application will configure the input for units of power (kW). The analog output signal from a power meter device provides a compatible output signal and can be connected to this input. The Utility Monitoring application uses this input to calculate energy consumption (kWh) on a weekly, daily, and monthly basis by integrating the instantaneous power samples (approximation by finite steps). The application considers a varying sampling frequency of the input signal to produce an energy calculation.

kWh Pulse Input

When Electr Inp Type is set to kWh Pulse, the Utility Monitoring application will configure the input for units of energy (kWh). A MultiFlex board analog input, configured as a pulse accumulator, provides a compatible signal that can be connected to the Utility Monitoring input. From this input signal, the Utility Monitoring application calculates energy consumption on a weekly, daily, and monthly basis by accumulating the variable energy pulses provided by the pulse accumulator physical input.

An instantaneous power output is also calculated. This calculation uses the energy consumed over a one-minute period to calculate the average power over the minute period.

Current/Voltage Inputs - Single Three Phase

When the Electr Inp Type parameter is set to Current or Current 3-phase, the application calculates energy consumption by calculating instantaneous power and then integrating the power calculation by finite step approximation. The application supports a single current input for single phase monitoring, or three current inputs for three phase monitoring (wye configuration). Additional voltage and power factor inputs are provided so that the power can be calculated. These inputs can be set to fixed values or can be connected via pointers to real-time voltage and power factor outputs from a smart power meter.

9.16.2 Consumption Totalizing

9.16.2.1 Fixed Period Totalizers

The application provides Daily, Weekly, and Monthly totalizer outputs. The Daily output accumulates throughout the day and resets to zero at 00:00 (midnight) every day. The Weekly output accumulates throughout the week and resets to zero at 00:00 on the day of the week specified by the WEEK START DAY input. The Monthly output accumulates throughout the calendar month and resets to zero at 00:00 on the day of the month specified by the Month Start Day parameter. Before the fixed period totalizers are reset, their values will be logged in the Utility Base Log.

9.16.2.2 User Totalizer Output

The application also provides a user-defined totalizer output (User Win Total) that accumulates for a custom duration. The user can specify the duration window (User Win Dur) that the Totalizer Output will accumulate before it logs the value and resets to zero. This time interval can be configured from 1 minute to 24 hours. The totalized value will be logged in the Utility Base Log at the specified interval.

9.16.2.3 Utility Logging Group

For proper logging of totalizer outputs, the outputs must be associated with a logging group that is configured to be in Utility mode. By default, both the user defined totalizer and the fixed period totalizer outputs are associated to the Utility Base Log group. See **Section 5 Logging Groups** for more information on management of logging groups.

9.16.3 Demand Shedding

9.16.3.1 Overview

The application can monitor the rate of consumption and trigger an output to turn ON if the rate exceeds the user-specified setpoint. To trigger the output based on an instantaneous rate of consumption, the Demand Type parameter should be set to Real. To use the average rate of consumption, Demand Type should be set to Average.

9.16.3.2 Average Rate of Consumption

The application calculates the average rate of consumption over a window of time. This is considered the demand window. The window is configurable between 1 and 30 minutes via the Average parameter.

9.16.3.3 Shed Output

The application provides a demand shed digital output that turns ON (displayed as SHED) when the Present or Average rate of usage (configurable) exceeds a threshold setpoint (Demand SP). If the shed output is active and the usage rate drops below the Demand SP minus the Demand Deadband, the shed output will be OFF (displayed as RESTORE).

9.16.3.4 Demand Limit Exceeded Alarm

The application provides an application alarm to signal a high demand. The demand alarm limit and alarm delay will be configurable.

The demand alarm delay is the amount of time the application waits after the Shed Output turns on before the demand alarm is generated. When the Shed Output turns off, the demand alarm will return to normal.

9.16.3.5 Time In Shed Output

The application provides a Time In Shed output that indicates the total time that the Shed Output has been on. This output resets to zero every day at 00:00 hours.

9.17 Onboard I/O

Most of the general purpose input and output communications devices required by the Supervisory Controller to control refrigeration systems are connected to the controller via the I/O Network. The I/O Network is a simple RS485 three-wire connection that allows data interchange between input boards (which read sensor values and digital closures), output boards (which carry out commands from the controller), and the controller.

The Supervisory Controller has the onboard inputs and outputs which are initially supported by the controller.

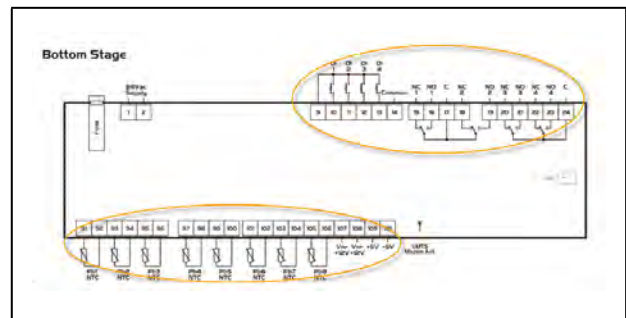

Figure 9-3 - Onboard Inputs and Outputs

Pulsing logic is now supported. When selecting Digital, the relay works as normal. When Pulse is selected, relay pulsing logic is applied. The relay will cycle periodically (turns ON and keeps ON for a specified period of time), and the CfgRL0x Period; CfgRL0x_OnTime parameters become available.

For the CfgRL01 OnTime parameter, when Pulse is selected, this parameter specifies the duty cycle (the ON percentage of the cycle period with a range from 0 to 100%).

For the CfgRL01 Period parameter, when Pulse is selected, this parameter specifies the entire cycle period.

9.17.1 Licensing

The number of Onboard I/O applications allowed is based on the total number of applications allowed on the Supervisory Controller platforms. Additional applications may be added with a separate license key.

9.17.2 Adding and Deleting Onboard I/O Application

The Onboard I/O application is initially installed by the system. The user is not able to add or delete it.

| | Description | Size | Limits |
|----|--------------|-------|--|
| 0 | Conf Probe 1 | 4 bit | ntc(0) - Ptc(1) - 2/20mA(2) - 4/20mA(3) - 0/10V(4) - 0/1V(5) - 0/5V(6) - DIG(7)-e_ntc(8) |
| 1 | Conf Probe 2 | 4 bit | ntc(0) - Ptc(1) - 2/20mA(2) - 4/20mA(3) - 0/10V(4) - 0/1V(5) - 0/5V(6) - DIG(7)-e_ntc(8) |
| 2 | Conf Probe 3 | 4 bit | ntc(0) - Ptc(1) - 2/20mA(2) - 4/20mA(3) - 0/10V(4) - 0/1V(5) - 0/5V(6) - DIG(7)-e_ntc(8) |
| 3 | Conf Probe 4 | 4 bit | ntc(0) - Ptc(1) - 2/20mA(2) - 4/20mA(3) - 0/10V(4) - 0/1V(5) - 0/5V(6) - DIG(7)-e_ntc(8) |
| 4 | Conf Probe 5 | 4 bit | ntc(0) - Ptc(1) - 2/20mA(2) - 4/20mA(3) - 0/10V(4) - 0/1V(5) - 0/5V(6) - DIG(7)-e_ntc(8) |
| 5 | Conf Probe 6 | 4 bit | ntc(0) - Ptc(1) - 2/20mA(2) - 4/20mA(3) - 0/10V(4) - 0/1V(5) - 0/5V(6) - DIG(7)-e_ntc(8) |
| 6 | Conf Probe 7 | 4 bit | ntc(0) - Ptc(1) - 2/20mA(2) - 4/20mA(3) - 0/10V(4) - 0/1V(5) - 0/5V(6) - DIG(7)-e_ntc(8) |
| 7 | Conf Probe 8 | 4 bit | ntc(0) - Ptc(1) - 2/20mA(2) - 4/20mA(3) - 0/10V(4) - 0/1V(5) - 0/5V(6) - DIG(7)-e_ntc(8) |
| 8 | Conf DI1 | 4 bit | Normal DI (0) - Pulse Counter (1) |
| 9 | Conf DI2 | 4 bit | Normal DI (0) - Pulse Counter (1) |
| 10 | Conf DI3 | 4 bit | Normal DI (0) - Pulse Counter (1) |
| 11 | Conf DI4 | 4 bit | Normal DI (0) - Pulse Counter (1) |

Table 9-11 - Size and Limits of the Inputs and Outputs

9.17.3 Status and Detail Screen

The Onboard I/O status screen, contains the following information:

- Relays status
- Digital inputs status
- Analog inputs status.
- General status
- Setup status
- Inputs status
- Outputs status
- Invert status

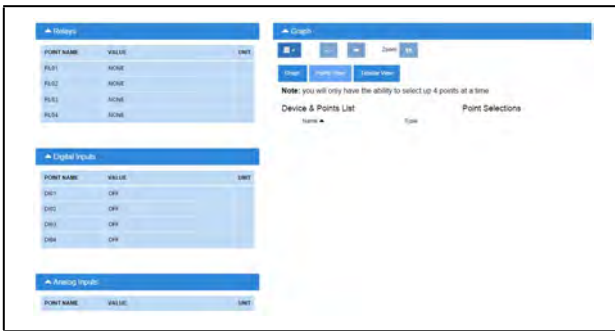

Figure 9-4 - Onboard I/O Status Screen

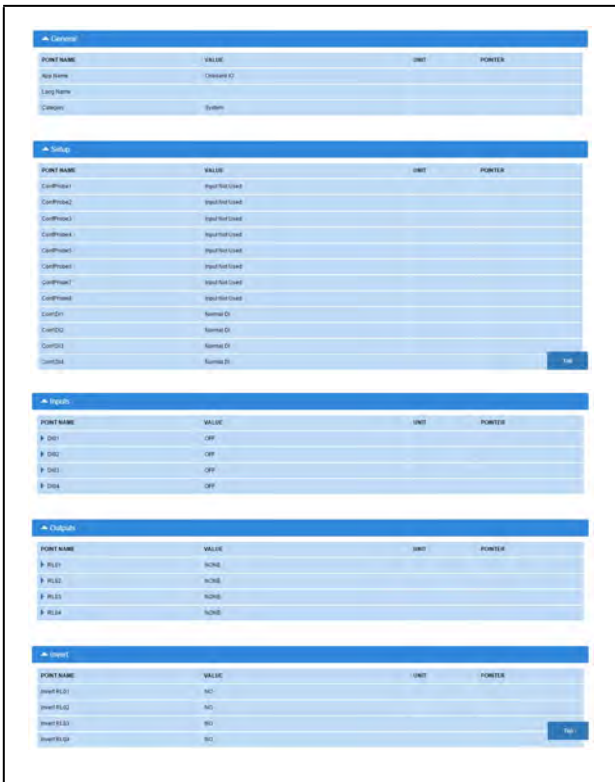

Figure 9-5 - Onboard I/O Status Screen

The Onboard I/O properties can be configure by setting the Edit Mode to ON on the screen drop-down menu on the upper right side of the screen.

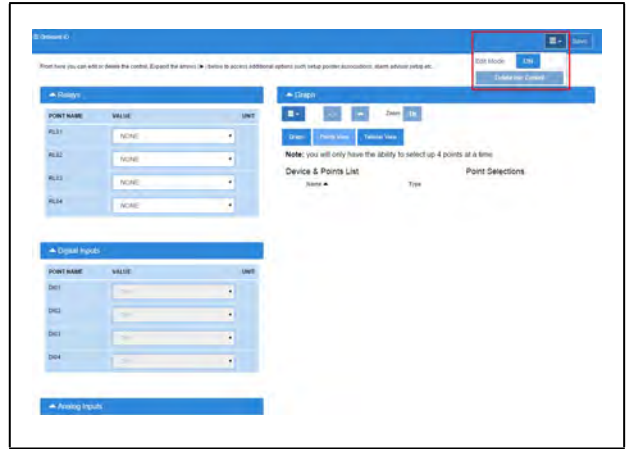

Figure 9-6 - Onboard I/O Detail Screen

9.17.4 Alarming

The alarm Read Data Failed AI# is generated if sensors are configured but disconnected.

If the advisory is reset, and the alarm/notice condition still exists, the delay period is honored.

Advisories returns to normal if the command value stays in the non-alarm/notice condition.

9.18 XR75CX 5.6

The XR75CX is a microprocessor based controller, suitable for applications on medium or low temperature ventilated refrigeration units. It has four (4) relay outputs to control compressor, fan, and defrost, which can be either electrical or reverse cycle (hot gas) and light (configurable).

It can also have up to four (4) NTC, CtC (EU or US type) probe inputs. The first probe is used for temperature control. The second probe is used to control the defrost termination temperature at the evaporator. One of the two (2) digital inputs can operate as a third temperature probe. The fourth probe is used to control the condenser temperature (for condenser alarm management) or to display a temperature value. Set the PbC parameter to CtC to support standard Copeland temperature sensors (factory default).

The controller is fully configurable through special parameters that can be easily programmed through the keyboard.

How To Add an XR75CX 5.6 Device on the Supervisor:

1. From the Home screen, click the Control Inventory icon (box). Click the drop-down arrow for Add Control in the appropriate category and select from the list.
2. Select the Control or Application Type - XR75CX 5.6, enter the Quantity, Control Name and Serial Type. Note that Serial Type information can be entered later. Click Save to add the application.
3. A Confirmation box will appear saying that the application is successfully added to the system, click Close or Edit these controls.
4. The system will display the new application(s) on the Site Summary screen.
5. Click the XR75CX 5.6 application panel box to view the application.
6. The system will display the XR75CX 5.6 application parameters.
7. The user can view and configure the properties of the application by setting the Edit Mode to "ON" on the screen drop-down arrow on the upper right of the screen.

How To Add an XR35CX 5.6/ XR35CX2.6 Device on the Supervisor:

1. From the Home screen, click the Control Inventory icon (box). Click the drop-down arrow for Add Control in the appropriate category and select from the list.
2. Select the Control or Application Type - XR35CX-5.6/ XR35CX2.6, enter the Quantity, Control Name and Serial Type. Note that Serial Type information can be enter later. Click Save to add the application.
3. A Confirmation box will appear saying that the application is successfully added to the system, click Close or Edit these controls.
4. The system will display the new application(s) on the Site Summary screen.
5. Click the XR35CX-5.6/ XR35CX 2.6 application panel box to view the application.
6. The system will display the XR35CX-5.6/ XR35CX 2.6 application parameters.
7. The user can view and configure the properties of the application by setting the Edit Mode to "ON" on the screen drop-down arrow on the upper right of the screen.

9.19 XR35CX 5.6 and 2.6

The Model XR35CX (32 mm x 74 mm) is a digital thermostat with off-cycle, defrost, designed for refrigeration applications at normal temperature. It has two relay outputs to control compressor and light (configurable). It can have a Real Time Clock (RTC) that allows programming of up to six daily defrost cycles, divided into holidays and workdays. A "Day and Night" function with two different setpoints is fitted for energy savings. It can also have up to four NTC or PT1000 probe inputs: the first one for temperature control, the second one located on the evaporator to control the defrost termination temperature. One of the two digital inputs can operate as a third temperature probe. The fourth probe is used to signal the condenser temperature alarm or to display a temperature value.

The RS485 serial output enables the controller to be connected to a network line that is MODBUS RTU compatible such as the monitoring units of XWEB family. The Hot Key receptacle allows the controller to be programmed by means of the Hot Key programming keyboard.

The controller is fully configurable through special parameters that can be easily programmed through the keyboard.

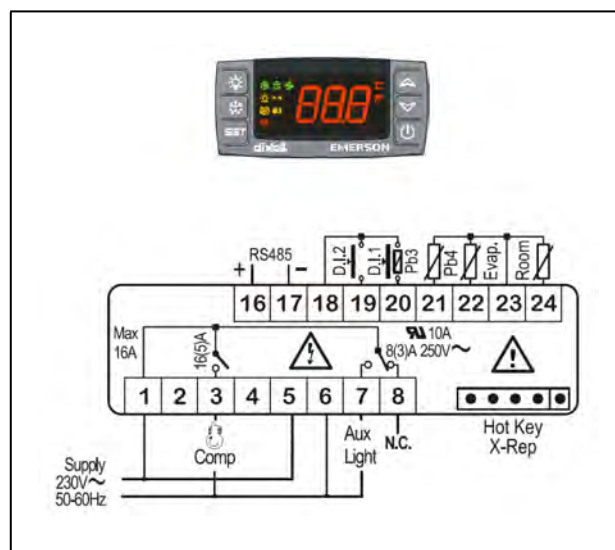

Figure 9-7 - XR35CX 5.6 and 2.6 Device

| Alarm | Description/Alarm Text |
|-----------------|---|
| EXTERNAL | External Alarm |
| DOOR OPEN | Open Door Alarm |
| 2EEPROM FAILURE | EEPROM Failure Alarm |
| CASE TEMP FAIL | Case temperature probe failure alarm |
| DEFR TERM FAIL | Defrost termination probe failure alarm |
| HIGH CASE ALM | High case temperature alarm |
| LO CASE ALM | Low case temperature alarm |
| RTC DATA LOST | RTC data lost alarm |
| RTC FAILURE | RTC failure alarm |

Table 9-12 - Diagnostic Alarms

9.19.1 Overview

The Supervisory Controller will provide an interface to the XR35CX and alarming. The XR35CX is networked with the Supervisory Controller to share sensor data with a Case Circuit application that controls the case refrigeration. It has two on-board relays that can be used as satellite outputs by the other Supervisory Controller applications.

Please refer to the *XR35CX I/O Installing and Operating Manual (P/N 026-1203)* for more information.

9.19.2 Command-Alarm Matrix

| Command | Description/Alarm Text |
|-----------------|---|
| Keyboard LOCK | The front panel is locked and cannot be used. |
| Keyboard UNLOCK | The front panel is unlocked and can be used. |
| Alarms Muting | Silences the alarm output. |

Table 9-13 - Diagnostic Alarms

The following is an example of Status Screen properties. Properties can be added to the Supervisory Controller.

| Input Property: | Value: | Units: | Status: | Output Property: | Value: | Units: | Status: |
|-----------------|--------|--------|---------|------------------|--------|--------|---------|
| | | | | CONTROL TEMP | NONE | DF | NA |
| | | | | DEFR TERM TEMP | NONE | DF | NA |
| | | | | MIXED TEMP | NONE | DF | NA |
| | | | | ACTIVE SETPT | NONE | DF | NA |
| | | | | DIG IN 1 | NOTACT | DIG | NA |
| | | | | DIG IN 2 | NOTACT | DIG | NA |
| | | | | ALARM | NOTACT | DIG | NA |
| | | | | LIGHTS | NOTACT | DIG | NA |
| | | | | COMPRESSOR | NOTACT | DIG | NA |
| | | | | ENRGY SAVE ACT | NOTACT | DIG | NA |
| | | | | REFG ACTIVE | NOTACT | DIG | NA |
| | | | | DEFROST ACTIVE | NOTACT | DIG | NA |
| | | | | KEYBOARD ACTIVE | NOTACT | DIG | NA |
| | | | | BUZZER ACTIVE | NOTACT | DIG | NA |
| | | | | HOLIDAY ACTIVE | NOTACT | DIG | NA |
| | | | | EXTERNAL ALARM | NOTACT | DIG | NA |
| | | | | DOOR OPEN | NOTACT | DIG | NA |
| | | | | EEPROM FAILURE | NOTACT | DIG | NA |
| | | | | CASE TEMP FAIL | NOTACT | DIG | NA |
| | | | | DEFR TERM FAIL | NOTACT | DIG | NA |
| | | | | HIGH CASE ALM | NOTACT | DIG | NA |
| | | | | LO CASE ALM | NOTACT | DIG | NA |
| | | | | RTC DATA LOST | NOTACT | DIG | NA |
| | | | | RTC FAILURE | NOTACT | DIG | NA |
| | | | | PROBE 3 | NONE | DF | NA |
| | | | | PROBE 4 | NONE | DF | NA |
| | | | | SET POINT OUT | NONE | DF | NA |

Table 9-14 - XR35CX 5 6 and 2 6 Status Screen Properties

9.20 XC645CX 2.5

The XC645CX is designed to manage both compressors and fans in a condensing system such as a pack. The compressors can be digital scroll, simple, multistage. Control is by means of a neutral zone or proportional band and is based on the pressure or temperature sensed in the LP suction (compressors) and HP (condenser) circuits. A special algorithm balances the run hours of the compressors to distribute the work load uniformly. The controllers can convert both LP and HP pressures and displays them as temperatures. The front panel offers complete information on the system's status by displaying the suction and condenser pressure (temperatures), the status of the loads, possible alarms or maintenance conditions. Each load has its own alarm input that is able to stop it when activated. Additionally, there are two inputs for low and high pressure switches: when these are activated, the system is stopped. The controller can be easily programmed at power-on by using the Hot Key. The controller can be connected to the XWEB controlling and monitoring system, through the TTL output, using the standard MODBUS RTU protocol.

How To Add an XC645 2.5 Device on the Supervisor:

1. From the Home screen, click the Control Inventory icon (box). Click the drop-down arrow for Add Control in the appropriate category and select from the list.
2. Select the Control or Application Type - XC645CX 2.5, enter the Quantity, Control Name and Serial Type. Note that Serial Type information can be enter later. Click Save to add the application.
3. A Confirmation box will appear saying that the application is successfully added to the system, click Close or Edit these controls.
4. The system will display the new application(s) on the Site Summary screen.
5. Click the XC645CX 2.5 application panel box to view the application.
6. The system will display the XC645CX 2.5 application parameters.
7. The user can view and configure the properties of the application by setting the Edit Mode to ON on the screen drop-down arrow on the upper

right of the screen.



Figure 9-8 - XC645CX 2.5 Device

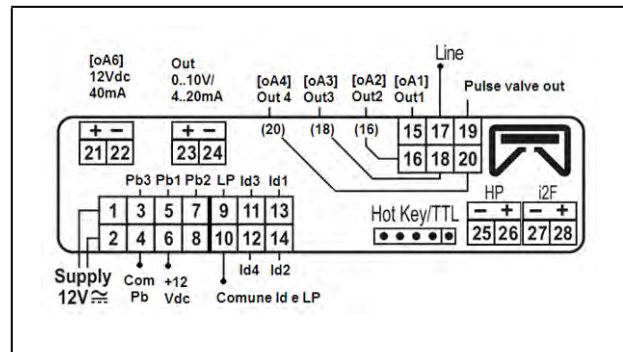

Figure 9-9 - XC645CX 2.5 Wiring

9.20.1 Application Advisories

| Alarm | Description |
|-----------------|---|
| ERROR PB1 | Error Pb1 |
| ERROR PB2 | Error Pb2 |
| ERROR PB3 | Error Pb3 |
| LIQUID LEVEL | Liquid Level Alarm |
| LOW SUCT ALARM | Low Suction Alarm |
| HIGH SUCT ALARM | High Suction Alarm |
| LOW COND ALARM | Low Condens. Alarm |
| HIGH COND ALARM | High Condens. Alarm |
| LOAD 1 ALARM | Load 1 Alarm |
| LOAD 2 ALARM | Load 2 Alarm |
| LOAD 3 ALARM | Load 3 Alarm |
| LOAD 4 ALARM | Load 4 Alarm |
| LOAD 5 ALARM | Load 5 Alarm |
| LOAD 6 ALARM | Load 6 Alarm |
| LP SWITCH ALARM | Low Press. LP Switch |
| HP SWITCH ALARM | High Press. HP Switch |
| ELECTRONIC LP | Electronic low press |
| DGS DLT ALARM | Digital Scroll High Discharge Line temp |

Table 9-15 - XC645CX 2.5 Application Advisories

9.20.2 Command-Alarm Matrix

| Command | Description/Alarm Text |
|-----------------|---|
| Keyboard LOCK | The front panel is locked and cannot be used. |
| Keyboard UNLOCK | The front panel is unlocked and can be used. |
| Alarms Muting | Silences the alarm output. |

Table 9-16 - Diagnostic Alarms

| Input Property: | Value: | Units: | Status: | Output Property: | Value: | Units: | Status: |
|-----------------|--------|--------|---------|------------------|--------|--------|---------|
| COMP SETPT IN | NONE | PSI | | SUCTION TEMP | NONE | DF | NA |
| FAN SETPT IN | NONE | PSI | | DISCHARGE TEMP | NONE | DF | NA |
| | | | | SUCTION PRESS | NONE | PSI | NA |
| | | | | DISCHARGE PRESS | NONE | PSI | NA |
| | | | | COMP SETPT OUT | NONE | PSI | NA |
| | | | | FAN SETPT OUT | NONE | PSI | NA |
| | | | | COMPRESSOR 1 | NOTACT | DIG | NA |
| | | | | COMPRESSOR 2 | NOTACT | DIG | NA |
| | | | | FAN 1 | NOTACT | DIG | NA |
| | | | | FAN 2 | NOTACT | DIG | NA |
| | | | | FAN 3 | NOTACT | DIG | NA |
| | | | | VALVE OUTPUT | NOTACT | DIG | NA |
| | | | | ON | NOTACT | DIG | NA |
| | | | | KEYBOARD | NOTACT | DIG | NA |
| | | | | ALARMS MUTING | NOTACT | DIG | NA |
| | | | | DIGITAL % MOD | NONE | PCT | NA |
| | | | | SUCTION AVERAGE | NONE | PSI | NA |
| | | | | ERROR SUCT | NOTACT | DIG | NA |
| | | | | ERROR DISCH | NOTACT | DIG | NA |
| | | | | CFG ERROR AL | NOTACT | DIG | NA |
| | | | | EEPROM FAIL AL | NOTACT | DIG | NA |

Table 9-17 - XC645 Status Screen Properties

9.21 XR75CX Case Display

The XR75CX-Case Display is a microprocessor based controller, suitable for applications on medium or low temperature ventilated refrigeration units. The Supervisory Controller will communicate with the XR75CX Case Display via MODBUS using the Open MODBUS infrastructure.

How To Add an XR75CX CaseDsp Device on the Supervisor:

1. From the Home screen, click the Control Inventory icon (box). Click the drop-down arrow for Add Control in the appropriate category and select from the list.
2. Select the Control or Application Type - XR75CX CaseDsp, enter the Quantity, Control Name and Serial Type. Note that Serial Type information can be enter later. Click Save to add the application.
3. A Confirmation box will appear saying that the application is successfully added to the system, click Close or Edit these controls.
4. The system will display the new application(s) on the Site Summary screen.
5. Click the XR75CX CaseDsp application panel box to view the application.
6. The system will display the XR75CX CaseDsp application parameters.
7. The user can view and configure the properties of the application by setting the Edit Mode to "ON" on the screen drop-down arrow on the upper right of the screen.

9.21.1 Overview

The Supervisory Controller will provide an interface to the XR75CX CD and alarming. The XR75CX CD can be networked with the Supervisory Controller to share sensor data with a Standard Circuit application that controls the case refrigeration, and it has four on-board relays that can be used as satellite outputs by the other Supervisory Controller applications.

9.21.2 Application Advisories

The application is facilitate the various alarming and

setting of status information:

| Advisory (Display Name) | Category | Description |
|-------------------------|--------------|---|
| dA sensor failure | Non-Critical | Discharge air temperature |
| Pr sensor failure | Non-Critical | Product temperature sensor fails |
| Co sensor failure | Non-Critical | Coil out temperature sensor fails |
| dF sensor failure | Non-Critical | Defrost temperature sensor fails |
| EEPROM failure | Non-Critical | an alarm condition exists in the XR75CX Case Display application |
| Wrong device | Notice | The device code contained in the device ID information is not correct |
| Network device offline | Critical | Network device offline alarm |

Table 9-18 - Application Advisories



NOTE: When an XR75CX-CD is associated with a Standard Circuit application in the Supervisory Controller, a Case Temp Hi Limit Exceeded or Case Temp Lo Limit Exceeded alarm that occurs for the XR75CX-CD's associated case will cause the main module and remote display's Alarm LED to turn ON, indicating an active alarm. Unlike XR75CX-CD's temperature sensor alarms, a "No Alarm" message is shown on the display if a case temperature alarm occurs.

The following is an example of Case Display properties. Properties can be added to the Supervisory Controller.

| Input Property: | Value: | Units: | Status: | Output Property: | Value: | Units: | Status: |
|-----------------|--------|--------|---------|------------------|---------|--------|---------|
| | | | | COMM STATUS | No Port | | NA |
| | | | | DISPL TEMP | NONE | DF | NA |
| | | | | DISCHARGE AIR | NONE | DF | NA |
| | | | | PRODUCT TEMP | NONE | DF | NA |
| | | | | COIL OUT TEMP | NONE | DF | NA |
| | | | | DEFROST TEMP | NONE | DF | NA |
| | | | | DIGITAL INPUT2 | NOTACT | DIG | NA |
| | | | | RELAY 1 STATE | NOTACT | DIG | NA |
| | | | | RELAY 2 STATE | NOTACT | DIG | NA |
| | | | | CD ALARM OUT | NOTACT | DIG | NA |
| | | | | RELAY 3 STATE | NOTACT | DIG | NA |
| | | | | RELAY 4 STATE | NOTACT | DIG | NA |
| | | | | EEPROM ALARM | NOTACT | DIG | NA |

Table 9-19 - XR75CX Case Display Status Screen Properties

9.21.3 Inputs

RelayNCommand - The XR75CX CD has four on-board relays that may be used as satellite outputs by the other Supervisory Controller applications. "RelayNCommand" can be connected to the output of the other applications and control other physical device, such as fan and light. QA can test the output for the corresponding relay and test the relay output of IPX and Onboard IO.

Digital InputN - The two points show status for the two digital inputs of XR75CX CD, they can be used as the output source for pointers.

RelayNFailSafe - The XR75CX-CD can operate in Normal mode and Standalone (failsafe) mode. When the case display is communicating normally with the Supervisory Controller, it is operating in Normal mode. If the communication between the case display and the Supervisory Controller is interrupted, the case display will go into Standalone (failsafe) mode. The value of Realy1FailSafe could be tested by the value of the corresponding relay in Standalone mode.

9.22 XR75CX 2.6

Model XR75CX 2.6 (32 mm x 74 mm) is a microprocessor based controller, suitable for applications on medium or low temperature ventilated refrigeration units. It has four relay outputs to control compressor, fan, and defrost, which can be either electrical or reverse cycle (hot gas) and light (configurable). It can have a Real Time Clock (RTC) that allows programming of up to six daily defrost cycles, divided into holidays and workdays. A "Day and Night" function with two different setpoints is fitted for energy saving.

It can also have up to four NTC or PT1000 probe inputs; the first one for temperature control and the second probe is located on the evaporator to control the defrost termination temperature and to manage the fan. One of the two digital inputs can operate as a third temperature probe. The fourth probe is used to signal the condenser temperature alarm or to display a temperature value.

The RS485 serial output enables the unit to be connected to a network line that is MODBUS-RTU compatible, such as the monitoring units of the XWEB family. The Hot Key receptacle allows the controller to be programmed by means of the Hot Key programming keyboard.

The controller is fully configurable through special parameters that can be easily programmed through the keyboard.

How To Add an XR75CX 2.6 Device on the Supervisory:

1. From the Home screen, click the Control Inventory icon (box). Click the drop-down arrow for Add Control in the appropriate category and select from the list.
2. Set the Port ID and Address and click checkmark to add and save changes. Click the wrench icon to edit and the pages icon to duplicate.
3. A Confirmation box will appear saying that the application is successfully added to the system, click Close or Edit these controls.
4. The system will display the new application(s) on the Site Summary screen.
5. Click the XR75CX 2.6 application panel box to view the application.
6. The system will display the XR75CX 2.6 application parameters.
7. The user can view and configure the properties of the application by setting the Edit Mode to "ON" on the screen drop-down arrow on the upper right of the screen.



Figure 9-10 - XR75CX 2.6 Device

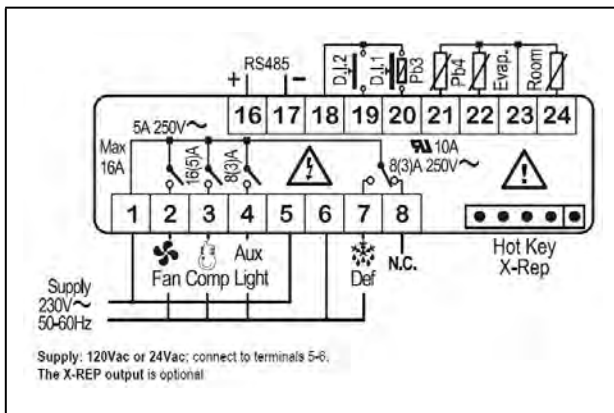

Figure 9-11 - XR75CX 2.6 Wiring Connection

9.22.1 Application Advisories

| Alarm | Description |
|----------------|---|
| EXTERNAL ALARM | External alarm |
| DOOR OPEN | Open Door alarm |
| EEPROM FAILURE | EEPROM Failure alarm |
| CASE TEMP FAIL | Case temperature probe failure alarm |
| DEFR TERM FAIL | Defrost termination probe failure alarm |
| HIGH CASE ALM | High case temperature alarm |
| LO CASE ALM | Low case temperature alarm |
| RTC DATA LOST | RTC data lost alarm |
| RTC FAILURE | RTC failure alarm |

Table 9-20 - XR75CX 2.6 Application Advisories

9.22.2 Command

| Command | Description/Alarm Text |
|------------------|---|
| Keyboard LOCK | The front panel is locked cannot be used. |
| Keyboard UNLOCK | The front panel is unlocked and can be used. |
| Alarms Muting | Silences the alarm output. |
| Defrost Periodic | Sends the Disable Standalone Defrost command. |

Table 9-21 - XR75CX 2.6 Commands

9.23 T-Stat

The T-Stat communicates with the Supervisory Controller using the MODBUS network. The thermostat enables the controller to read status information from the device as well as send operational setpoints to the device. The device communicates using 8 data bits and 1 stop bit. For the full thermostat user manual, refer to *P/N 026-1729*.

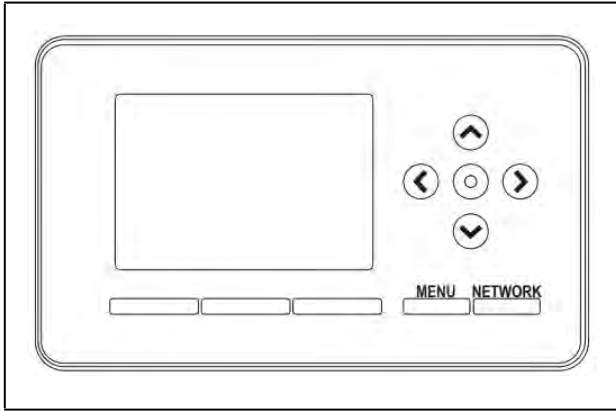

Figure 9-12 - Commercial Communicating Thermostat

This thermostat replaces thermostats for the following types of system:

- Standard Heat and Cool Systems
- Two Stage Heat and Two Stage Cool Systems
- Air Source Heat Pump (with Aux. or Emergency Heat)
- Ground Source Heat Pump (with Aux. or Emergency Heat)
- Air or Ground Source Heat Pump (No Aux. or Emergency Heat)
- Standard Heat Only Systems
- Standard Central Air Conditioning
- Gas or Oil Heat
- Electric Furnace
- All Systems Listed Above with Economizer Control

9.23.1 General Control

- The Supervisory Controller communicates with the device via Modbus. The thermostat communicates using 8 data bits, and 1 stop bit. Baud rate and parity can be changed on the device using dip switches.
- The Supervisory Controller will just provide an interface to the devices. The White Rodgers Thermostat monitors all information.

9.23.2 Alarms

- Online/Offline - Standard Supervisory Controller communication alarms
- White Rodgers Thermostat defined alarm outputs from the device.

9.23.3 Device Commissioning

To add a White Rodgers Thermostat to the Supervisory Controller network, from the Supervisory Controller:

- This is accomplished using Commissioning from the Add and Remove Device screen.

Addressing the Thermostat:

- The address can be set by adjusting dip switches on the device. Follow the instructions in the White Rodgers Thermostat installation guide for more details.
- If the addresses match and the serial port and physical wiring are correct, the device should be shown as online in the Network Status screen.

9.24 Touch T-Stat

The Programmable Touchscreen Thermostat is a configurable device intended for light commercial applications. The thermostat is a communicating, intelligent sensor and controller combination with built-in temperature and humidity sensors used to control systems such as conventional Rooftop Units (RTU) and Heat Pumps (HP). The thermostat communicates over a Modbus RTU network that easily integrates with a building management system (BMS). For the full user manual, refer to *P/N 026-1739*.



Figure 9-13 - Programmable Touch T-Stat

9.25 Energy Meter

Energy Meter provides a flexible energy monitoring solution. The pulse output and the unique phase alarm feature allow the device to support a wide variety of applications. The device is also compatible with many types of current transformers that allow easy retrofits.



Figure 9-14 - Energy Meter

How To Add an Energy Meter Device on the Supervisor:

1. From the Home screen, click the Control Inventory icon (box). Click the drop-down arrow for Add Control in the appropriate category and select from the list.
2. Select the Control or Application Type - Energy Meter 0.2, enter the Quantity, Control Name and Serial Type. Note that Serial Type information can be entered later. Click Save to add the application.
3. A Confirmation box will appear to notify that the application is successfully added to the system, click Close or Edit these controls.
4. The system will display the new application(s) on the Site Summary screen.
5. Click the Energy Meter application panel box to view the application.
6. The system will display the Energy Meter application parameters.
7. The user can view and configure the properties of the application by setting the Edit Mode to ON on the screen drop-down arrow on the upper right of the screen.

9.26 Data Logging and Graph

The Data Logging and Graph Enhancement includes navigation to Single Log, Multi-Point, or Real-Time graphing screens. It also has download, email and print capabilities of log data from Multi-Point and Real-Time logging group.

9.27 Flexible Combiner

The Flexible Combiner application is a highly advanced and versatile I/O control program used to combine multiple analog and digital input values using programmed equations similar to those used in spreadsheets.

A Flexible Combiner application may have up to eight analog outputs and four digital outputs, each of whose values are determined by user-programmed equations that mathematically combine up to eight analog inputs and eight digital inputs. Four of the analog outputs have the ability to remember their output state over an Site Supervisor power cycle. Additionally, up to four alarms can be set up whose trigger and alarm delays are equations. Alarm type, priority, and the message for each alarm are user-configurable.

Equations used to calculate output values and time delays may use mathematical combinations of any of the Flexible Combiner's analog and digital inputs, as well as numeric and named constants, operators, functions, and even rudimentary if-then logic functions. For control of digital outputs, the Flexible Combiner also supports separate equations that determine ON and OFF delays.

The user can set up to four alarms whose trigger and alarm delays are equations. The user may also choose the alarm type, priority, and the message for each alarm.

The Flexible Combiner may also be programmed to operate a digital output as a PWM (pulse width modulation) output. In this instance, the equation written for a PWM output determines its period and pulse width. A typical Flexible Combiner application consists of three types of components: inputs, equations, and outputs. For more information about this application, see the Flexible Combiner manual (P/N 026-1620).

Using Refrigerants in Flex Combiner Equations

When referencing a refrigerant, the Flex Combiner application will use an abbreviation, which will be the refrigerant designation such as "R402A" without any hyphen and a single character suffix added based on the curve used:

- M = Mid-Point
- E = End-point - table follows dew, then bubble with crossover at 10DC (50DF)
- D = Dew (Vapor) point
- B = Bubble (Liquid) point

To enter a refrigerant in the Flex Combiner algorithm, please follow the below syntax when entering equation: T2P (A12, R438AM).

9.28 RLDS (Refrigerant Leak Detector System)

The RLDS device detects the presence of gas leaks and provides for the continuous monitoring of refrigerant gas levels in up to 16 separate test zones or channels. The system is programmed to monitor a variety of gases and independent leak (small), spill (medium), and evacuation (large) levels may be designated for each zone. The RLDS also retains a log of previous readings that can be accessed for analysis. For more information on the RLDS, refer to the RLDS user manual (P/N 026-1309).



Figure 9-15 - RLDS

9.28.1 Communication

The RLDS features full two-way communications via the RS485 interface. MODBUS RTU is the communication protocol standard and can be connected directly to the Supervisory Controller.

The device default serial setup values are:

- Baud rate - 19200
- Data size - 8
- Parity - N
- Stop bits - 1

9.28.2 Supported Gases

The RLDS gas software library allows each zone to be independently selected to monitor any commonly used refrigerant including, but not limited to, the following: R22, R134a, R404A, R407A, R407C, R410A, R422A, R422D, R427A, R507, CO₂, and Ammonia. For a complete gas listing, refer to the RLDS manual P/N 026-1309.

9.29 ECB VAV

The BACnet VAV (Variable Air Volume) Control Network provides a complete building energy control and conservation solution for HVAC systems using VAV components. The VAV Control Network comprises the Discharge Air Controller (DAC), BACnet MS/TP IP VAV Controller, and VAV Smart Thermostat to supply a variable amount of conditioned airflow to different zones of a building. See the BACnet VAV user manual P/N 026-1221 for more information.



Figure 9-16 - BACnet VAV

9.30 MRLDS (Modular Refrigerant Leak Detector Sensors)

The MRLDS-250 NDIR (non-dispersive infrared) is a state-of-the-art fixed gas detector that can detect a wide range of refrigerant gases. The MRLDS-250 can be used on a stand-alone basis or integrated into controls or a Building Management System (BMS). The MRLDS-250 can be used in locations that require continuous monitoring and to add gas detection solutions to an existing system. The MRLDS-250 NDIR refrigerant gas detectors are available in two versions: broadband and gas-specific. See the MRLDS-250 user manual *P/N 026-1315* for more information.



Figure 9-17 - The MRLDS-250

MRLDS-450 Gas Detection Series of instruments continuously monitor ambient air (indoor or outdoor) for the following gas types: refrigerants, oxygen, and toxic and combustible gases.



Figure 9-18 - The MRLDS-450

The MRLDS-450 refrigerant gas detector is designed for use in refrigeration applications and with the integrated audio-visual alarm indication, can be operated as a stand-alone unit (with additional local alarm signaling as required), or it may be connected to a facility's building management system (BMS). For more information on the MRLDS-450, refer to the MRLDS450 user manual (*P/N 026-1316*).

9.31 Control Link Anti-Condensate Controller (CL ACC)

CL ACC can be added, deleted, and commissioned, can take actions on alarm instances, and support data handling.

The Serial Connection Manager can create the MODBUS Master process based on the settings in System Settings. If no MODBUS connections are defined, no MODBUS processes can be created. Also, if a connection is changed, the previous connection will stop, and the new connection is created. In the case of MODBUS, Serial Connection Manager will stop the associated MODBUS process.

9.31.1 Alarm Handling Logic

If any alarm condition exists, the General Alarm Output is set to ON. The individual alarm outputs is set according to which is alarm is present. If the condition clears, the alarm is reset automatically.

9.31.2 Alarms Configuration

The alarms can be individually set to their advisory type (Notice, Non-Critical, Critical), Category, Display Message, Repeat Rate, and Monitoring. (The device will generate the alarm and does not have any way to externally disable it).

9.32 HVAC Zone

An HVAC Zone is a collection of up to sixteen rooftop units or air handling units that work together to maintain the same temperature and humidity throughout a particular volume of space. The primary function of an HVAC Zone is to "manage" the operation of each individual HVAC unit by providing the temperature setpoints that will be used in Temperature Control. Zones are also responsible for ordering HVAC units to dehumidify and determining when outside air conditions are favorable to economize.

HVAC Zones can be edited, deleted, and associated with other applications and devices and copy built-in properties of an instance of an HVAC Zone.

9.32.1 How It Works

An HVAC Zone is built by creating an HVAC Zone application in the Supervisory Controller device. All HVAC unit applications that are part of the HVAC Zone must be connected with the HVAC Zone application. This connection process is known as “association.”

When a rooftop unit or AHU is associated with an HVAC Zone, the Supervisory Controller automatically makes a series of I/O connections between the HVAC Zone application and the individual MultiFlex RTU or AHU application. From that point, the HVAC Zone is responsible for passing the following information to the individual unit:

- The heating and cooling setpoints that the unit will use during occupied and unoccupied building times.
- A command to operate in either occupied or unoccupied mode (based on the HVAC Zone application’s own time schedule input).
- Outdoor air and outdoor relative humidity values.
- A signal to enable or disable economization (based on the Zone application’s own economization checking method).
- A signal to begin or end dehumidification (based on the Zone application’s own humidity reading and dehumidification setpoint).
- A signal indicating the current season is either SUMMER or WINTER.
- The combined HVAC Zone Temperature and HVAC Zone humidity (based on a combination of each HVAC unit’s space temperature and space humidity).
- The fallback temperature and humidity setpoints to use in case the unit loses contact with its HVAC Zone application.

9.32.2 Compatible Applications to be Connected to HVAC Zones

There are three different HVAC applications that may be associated with an HVAC Zone application:

- a MultiFlex RTU application
- a MultiFlex RCB application
- an AHU application

The MultiFlex RTU and RCB applications interface with the MultiFlex RTU and RCB I/O Network boards that control rooftop units. AHU applications use input and output points on the I/O Network to control air handling units.

9.32.3 Temperature Control

HVAC Zone applications do not control temperature themselves. HVAC Zone applications pass along the setpoints that an HVAC unit will use. The individual unit is responsible for controlling the setpoint using its own temperature input.

The HVAC Zone application pass along eight different setpoints, which are shown in **Table 9-22**. The application that receives the setpoints can only use one cooling and one heating setpoint. The pair of setpoints the application will use determines whether the current season is SUMMER or WINTER and whether the building is OCCUPIED or UNOCCUPIED (both of which are supplied by the Zone).

| Cooling | Heating |
|------------------|------------------|
| SUMMER COOL OCC | SUMMER HEAT OCC |
| SUMMER COOL UOCC | SUMMER HEAT UOCC |
| WINTER COOL OCC | WINTER HEAT OCC |
| WINTER COOL UOCC | WINTER HEAT UOCC |

Table 9-22- Cooling/Heating Setpoints

9.32.4 HVAC Zone Temperature

Each MultiFlex RTU and AHU application has a space temperature output that is equal to the unit’s current Control Temperature. When associated with an HVAC Zone application, this space temperature output is connected to one of the 16 HVAC Zone Temperature inputs in the HVAC Zone application. These 16 inputs are combined using a user-defined combination method to yield the HVAC Zone Temperature.

HVAC Zone Temperature provides an overview of the unit’s performance in heating and cooling within the HVAC Zone. The HVAC Zone Temperature can be used as a temperature control input by one or all of the HVAC Zone’s application.

9.32.5 Economizer Control

An HVAC Zone application is responsible for analyzing outside air conditions and determining if the conditions are suitable for bringing in outside air. If the air condition is suitable, the HVAC Zone sends a signal to its associated HVAC units telling them that economization is OK. If not, it sends a signal to disable economization.

It is up to the associated HVAC unit to process the economization information and open the dampers.

9.32.6 Economization Enable

There are possible ways an HVAC Zone application may determine when conditions are favorable for economization:

1. **Enthalpy Switch** - An enthalpy switch is a digital device that is pre-set to detect when the temperature and humidity levels are appropriate for economization. When the conditions are appropriate, this switch sends an OK (ON) signal to the Zone application. Otherwise, the switch sends a NOT OK (OFF) signal.
2. **Dewpoint Setpoint** - A dewpoint probe measures the dewpoint of the outside air and is compared to a setpoint. If the outside air dewpoint is less than the setpoint, economization is enabled. If it is higher than the setpoint, economization is disabled.
3. **Calculated Enthalpy** - The HVAC Zone application calculates the outside air enthalpy by reading the value of a relative humidity sensor and an outdoor air temperature sensor. This calculated enthalpy is compared to a setpoint. If the enthalpy is less than the setpoint, economization is enabled. If greater, economization is disabled.
4. **Dewpoint Fail-Safe** - This is similar to method Dewpoint Setpoint, except that an outdoor temperature sensor value is compared to the setpoint instead of a dewpoint probe's value. This comparison is a poor substitute for actual dewpoint readings and is recommended for use as a fail-safe only. When possible, use humidity or dewpoint sensors.
5. **Temperature Comparison** - The AHU Control application simply compares the temperature of the inside air with the temperature of the outside air. If the outside air is cooler than the inside air, economization is enabled.
6. **In vs. Out Enthalpy** - This strategy requires indoor and outdoor humidity sensors and also indoor and outdoor temperature sensors. The enthalpy of the outdoor air is calculated and compared to the enthalpy of the indoor air. If the outdoor air enthalpy is less than the indoor air enthalpy, economization is enabled. Otherwise, economization is disabled.

You can choose a different method to use in summer and winter months. Also, an alternate method may be specified that will be used as a fail-safe when the primary method is not available (due to sensor failure).

9.32.7 The Effect of Enabling Economization

Both MultiFlex RTU and AHU applications support the use of both two-position (digital) and variable-position (analog) economizers. Digital economizers, when enabled, behave like a first stage of cool. When analog economizers are enabled, the MultiFlex RTU or AHU will modulate the opening percentage of the dampers based on its own mixed air temperature measurements.

9.32.8 Dehumidification Control

An HVAC Zone application is responsible for reading the relative humidity level within the HVAC Zone, comparing it to a dehumidification setpoint, and sending a command to dehumidify when the humidity is above the setpoint.

Once the HVAC Zone humidity level rises above the setpoint, dehumidification will be active in all the HVAC Zone application's associated HVAC units until the indoor relative humidity falls below the setpoint minus the dehumidification hysteresis value. An example of is shown in the figure below:

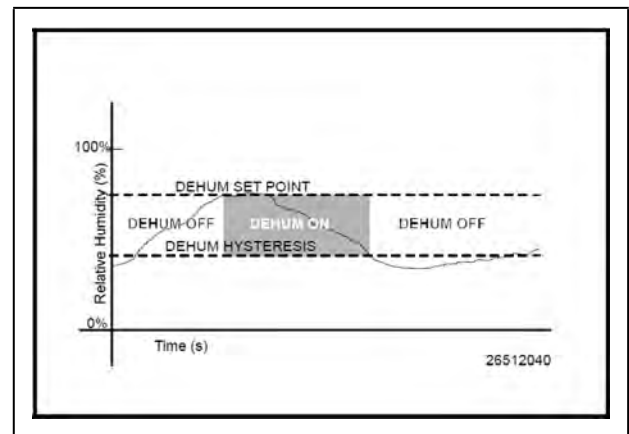

Figure 9-19 - Dehumidification Control

The need for dehumidification may also be determined by a digital humidistat. In this case, dehumidification is active only when the humidistat input is ON.

9.32.9 HVAC Zone Humidity Input

Unlike HVAC Zone Temperature, which has 16 inputs that combine into a single value, HVAC Zone humidity is designed to be provided by a single input. However, there may be some instances where one or more relative humidity sensors exist within an HVAC Zone (such as an installation where each MultiFlex RTU has its own humidity sensor for use in Stand-Alone mode). If you have multiple humidity sensors in an HVAC Zone and you want to combine these humidity sensor values to calculate HVAC Zone Humidity, use an Analog Combiner application to make the combination, and tie the HVAC Zone application's HVAC Zone Humidity input to the output of the combiner.

9.32.10 Enabling Dehumidification Effect

When an HVAC Zone application determines that dehumidification is needed, it sends an ON signal to all its associated controllers, signaling them to begin dehumidification. It is up to the individual MultiFlex RTU, RCB, or AHU to perform the dehumidification.

9.32.10.1 MultiFlex RTUs and RCBs

Once the MultiFlex RTU and RCB applications acknowledge the signal to begin dehumidification, it will search its outputs for a dehumidification device. If one is configured, this device will be turned ON. Afterwards, cool stages will be cycled ON (up to a user-defined maximum number of stages) until all stages are ON or until the Zone application signals dehumidification is complete. When dehumidification is complete, the stages will cycle OFF followed by the dehumidification device.

9.32.11 Optimum Start/Stop (OSS)

Optimum Start/Stop (OSS) is a feature that works along with the HVAC Zone application's occupied and unoccupied temperature control modes. OSS takes control of heating and cooling several minutes before the Zone application is scheduled to change occupancy states. It prepares the area for the upcoming change in setpoints. As a result, when the occupancy state changes, the temperature is comfortably within the range of the new setpoint.



NOTE: OSS applies only to Zone applications that use a time schedule to change occupancy states.

Overrides initiated by the digital BYPASS TO OCC or BYPASS TO UNOCC inputs will not initiate pre-starts or pre-stops.

The figure below shows an example of how pre-starts and pre-stops work in a heating application. From unoccupied mode, the pre-start period slowly increase the temperature up so that when the scheduled change from unoccupied to occupied mode occurs, the temperature is already at or near the occupied heating setpoint. During the pre-stop, which occurs before the HVAC Zone application goes from occupied to unoccupied mode, heating is suspended and the temperature is allowed to "coast" down to the unoccupied setpoint.

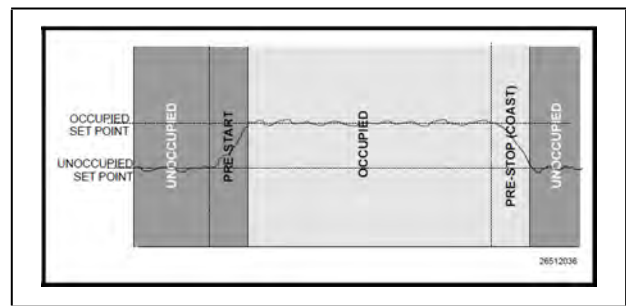

Figure 9-20 - Optimum Start/Stop (OSS)

9.32.12 Intelligent Pre-Starts and Pre-Stops

OSS is designed to handle pre-starts and pre-stops in the most energy-efficient manner possible. Every time a pre-start or pre-stop occurs, OSS measures the amount of time it takes to bring the temperature from the previous setpoint to within the "comfort zone" of the new setpoint (a user-defined range of values above and below the setpoint within which the temperature is considered acceptable). This duration is used to determine the average rate of temperature change, called the K-factor.

The K-factor is stored in the memory, along with the average value of the outdoor air temperature during the pre-start or pre-stop. Over time, collected K-factor data is sorted and combined into a table. As a result, by constantly observing and recording the results of previous pre-starts and pre-stops, OSS is able to intelligently guess how much time a pre-start or pre-stop mode should last based on the outside temperature.

AHU Control keeps track of three different kinds of K-factors:

- Heat K-factor - used to guess pre-start durations for AHUs operating in heating mode.
- Cool K-factor - used to guess pre-start durations for AHUs operating in cooling mode.
- Coast K-factor - a measurement of the change in temperature when no heating or cooling is active. This is used to determine pre-stop durations for both heating and cooling AHUs.

9.32.13 Setpoint Reset

If desired, Heat/Cools may be configured with a Setpoint Reset that varies the value of the heating and/or cooling setpoints based on an analog value from a reset sensor. This is most often used to vary the value of a heating or cooling setpoint based on the outside air temperature.

To set up a setpoint reset for heating or cooling, the user must specify the minimum and maximum range of reset sensor values, and the maximum range of setpoint adjustment.

As the value of the reset sensor varies within the minimum and maximum range, an equivalent portion of the maximum setpoint adjustment will be added or subtracted from the heating or cooling setpoint. When the reset sensor value is directly in between the minimum and maximum range values, nothing will be added or subtracted from the setpoint. Between the halfway point and the minimum value, part of the setpoint adjustment will be subtracted from the setpoint. Between the halfway point and the maximum value, part of the setpoint adjustment will be added to the setpoint. An example of this is shown in **Figure 9-21**.

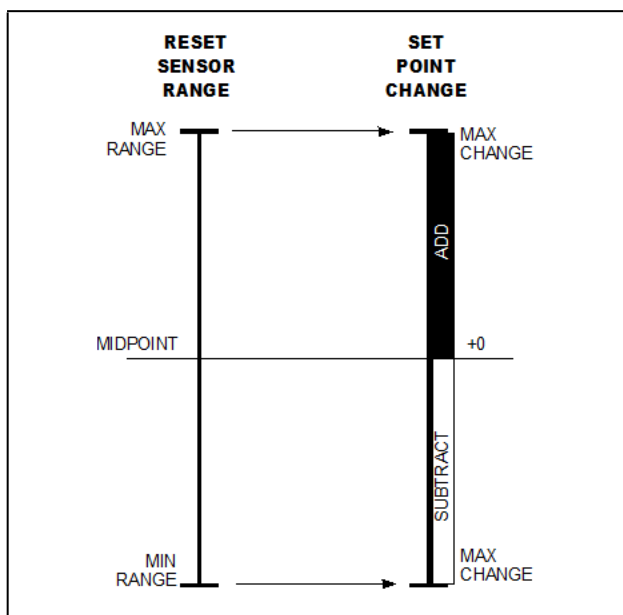

Figure 9-21 - Setpoint Reset Diagram

9.33 AHU

The AHU control application controls HVAC equipment, rooftop units, or air handlers. The number of AHU applications allowed is based on the total number of applications allowed on the device. The AHU application provides basic functionality to control a typical packaged HVAC unit. The packaged HVAC units have up to four stages of heating and cooling and may have a fresh air damper installed to allow free-air cooling (economization) when conditions permit.

How To Add an AHU Device on the Supervisor:

1. From Home screen, click the Control Inventory icon.
2. From the Control Inventory screen, expand the desired section (such as Refrigeration, HVAC, Lighting, and more) to locate the Add Control drop-down list that contains the application you wish to add. For AHU, expand the HVAC category and click the Add Control drop-down list and select AHU. Note that depending on the type of application you are adding, different fields are required and become editable (such as Protocol, Association, Port ID, Address, and more).
3. Click the checkmark to save changes. To add multiple instances quickly, click the Duplicate icon next to the wrench.
4. To remove an application, click the box next to the application name and click Delete Selected Application(s) in the upper right corner of the screen. Click OK or Cancel on the pop-up window to proceed with the action or stop.

9.34 Analog and Digital Combiner

The Analog Combiner application is used for analog inputs. Instead of using a single output source as an application input, 16 input source combinations may be used. For multiple inputs, a Multiple Input cell must be used. The Multiple Input cell is a simple application that reads data values from its inputs, combines them using a user-defined combination strategy, and sends the combined value to the desired application input. A common application for this is in the HVAC control where a single heating control value comes from the average number of temperature sensors throughout the building. Two different types of Multiple Input cells may be used if the inputs to be combined are analog or digital sources.

Inputs:

In addition to the 16 analog inputs, combined Analog Input 1 to 16, these inputs is combined based upon the CombMethod parameter setting. If they are not connected to any of the Analog Inputs, the input value will not be used in the calculation.

The user can connect a digital value to the Use Alt input to select an alternate combiner method – as defined in the AltCombMethod parameter. When the Use Alt input is true, the combiner logic will use the AltCombMethod parameter to calculate the combined value instead of the CombMethod parameter.

The user can also provide a digital value to the InputSelect. If this input is true, then the parameter InputSelect will indicate which AnalogInputXX the user would like to set to the combiner output value.

Outputs:

The Output value is the calculation of the combined analog sensor inputs. The Alternate-Out value is always filled with the calculated value as specified by the AltCombMethod parameter. The ActiveInput value is set to a specific value (1-16) and serves as the analog input value when the CombMethod is set to FIRST or SELECT.

9.35 Anti-Sweat Control

A case controller manages its anti-sweat heaters by monitoring the dewpoint in and around the case area. The dewpoint input value is compared to the anti-sweat application's control setpoints (the Full ON setpoint and the Full OFF setpoint). Based on this comparison, the anti-sweat heaters will do one of three things:

- If the input is equal to or above the Full ON setpoint, the heaters remain ON 100% of the time.
- If the input value is equal to or below the Full OFF setpoint, the heaters will be ON 0% of the time (fully OFF).
- If the input value is between the Full ON and Full OFF setpoint, the heaters will be pulsed ON for a percentage of the specified time interval. The percentage is determined by proportionately measuring where the dewpoint falls between the range of values formed by the two setpoints.

Figure 9-22 shows an example of how anti-sweat control works. The setpoints (Full ON dewpoint= 80°F, Full OFF dewpoint = 20°F) form the range of dewpoints across which the heaters will be pulsed. When the measured dewpoint is 45°F (directly in between both setpoints), the percentage will be 50%, and the heaters will be pulsed ON for 5 seconds of the defined 10-second interval. If the dewpoint drops to 30°F, the percentage will lower to 20%, and the heaters will be on only 2 seconds out of every 10.

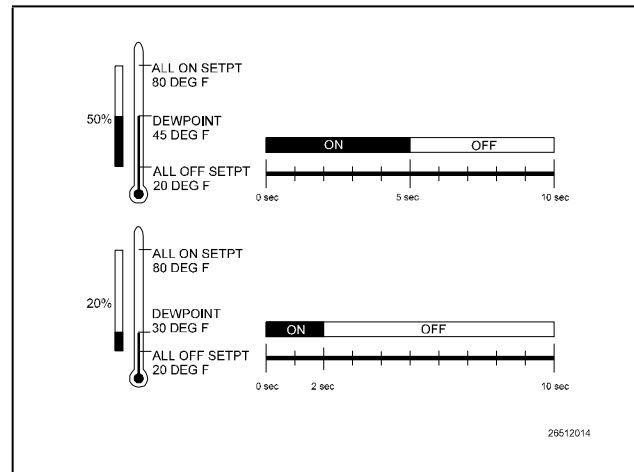

Figure 9-22 - Illustration of Anti-Sweat Control

9.36 Condenser Control

An air-cooled condenser consists of one or more fans that blow air across a manifold of tubing to cool heated refrigerant and condense it into a liquid. In an evaporative condenser, water is sprayed across a condenser coil, which cools the refrigerant as water is evaporated. Control of the evaporative condenser is similar in ways to the air cooled strategy in that the Condenser Control application uses PID control to activate or deactivate fans (thus increasing or decreasing the amount of evaporative cooling).

9.36.1 Air Cooled Condensers

An air-cooled condenser consists of one or more fans that blow air across a manifold of tubing to cool heated refrigerant and condense it into a liquid. The Site Supervisor controls condensers by activating or deactivating fans in order to maintain discharge pressure or temperature at or below a chosen setpoint.

A Condenser Control application may use either of two strategies to operate air cooled condensers: an air-cooled strategy, or a temperature differential (T-D) strategy.

9.36.1.1 Air Cooled Strategy

The air cooled strategy uses a simple PID control loop that compares a single Control In input to a PID setpoint. The resulting percentage is used to activate the condenser fan(s) necessary to bring the input value down below the setpoint.

Control inputs for air cooled strategies most commonly come from a pressure transducer mounted on either the discharge line, the condenser inlet, or the condenser outlet. However, temperature sensor values will also be accepted.

9.36.1.2 Temperature Differential Strategy

The temperature differential strategy attempts to keep a minimum amount of difference between the temperature of the refrigerant and the ambient outside temperature.

This strategy begins by determining the temperature of the refrigerant coming into the condenser. This can be supplied by either a temperature sensor or pressure transducer located near the condenser inlet; if it is a pressure transducer, its value will automatically be converted to a temperature value based upon the type of refrigerant.

The refrigerant temperature is subtracted from the value of an ambient air temperature sensor. The result is the temperature differential. It is this differential value that is compared to the PID setpoint for the purpose of determining the amount of total fan capacity to activate.

9.36.2 Evaporative Condensers

In an evaporative condenser, water is sprayed across a condenser coil, which cools the refrigerant as water is evaporated. Control of the evaporative condenser is similar in ways to the air cooled strategy in that the Condenser Control application uses PID control to activate or deactivate fans (thus increasing or decreasing the amount of evaporative cooling).

Like air-cooled condensers, evaporative condensers may be controlled by discharge pressure or temperature. They may also be controlled by water sump temperature. In addition, each evaporative condenser may have up to 16 "override" sensors (either temperature or pressure) that allow the condenser to be overridden to fast recovery mode.

9.36.3 Fan Control

Condenser Control applications can control three different kinds of fans: single-speed fans (up to 12 stages), two-speed fans, and variable-speed fans. All fan types are controlled by PID control; in other words, the Condenser Control application generates a percentage from 0% to 100% that corresponds to the amount of total fan power that should be active.

Single-speed fans translate the PID percentage into a percentage of total fan capacity. For example, if the PID percentage is 75%, then 75% of all condenser fan stages will be ON.

Two-speed fans use Cut In/Cut Out setpoints to translate the percentage into an OFF, LO, or HI fan state.

Variable-speed fans simply use the percentage to determine the fan speed. Thus, a 51% PID percentage will result in the fan running at 51% maximum speed.

VS-SS combined fan setup is for the combination of a variable-speed fan with single-speed fans. As PID increases from 0% to the minimum VS%, the fans will stage ON, and the VS% output will be at a minimum %. When PID reaches the minimum VS%, all defined fan stages will be ON. As PID rises from minimum VS% to 100%, the VS% output will match the PID output.

9.36.4 Condenser Split Mode

The Supervisory Controller is capable of operating condensers in a special mode that reduces its condensing capacity. This special mode is called split mode.

Split mode is most often used in cold climates during periods of low outside air temperature. Split mode is also sometimes used when heated refrigerant from the refrigeration system is being used as reclaim heat by an HVAC unit.

The most common way the Supervisory Controller achieves split mode in an air-cooled condenser with single-speed fans is to lock OFF 50% of the total number of fans. You may choose to lock OFF all odd-numbered fans, even-numbered fans, the first half of all fans, or the last half of all fans.

Split mode can also be achieved by activating a valve that bypasses a portion of the tubing in the condenser manifold. The resulting decrease in surface area results in reduced cooling.

9.36.5 Fast Recovery

Under certain conditions the system pressure may increase too quickly above the condenser setpoint to be reduced effectively by normal condenser control. The Supervisory Controller provides a user-definable fast recovery rate setpoint at which all the condenser fans are turned ON to reduce system pressure.

For air-cooled and temperature-differential condenser strategies, discharge pressure is always used as the control value that determines fast recovery. You may choose to enable or disable fast recovery, and also to include a delay when transitioning from one mode to the other.

For evaporative condensers, up to 16 “override” temperature sensors may be combined to yield a single override value that is used for fast recovery. Fast Recovery is always used in an evaporative condenser.

9.36.6 Hardware Overview

An overview of the input and output devices that make up a typical Condenser Control application is shown by shows the typical layout of an air-cooled condenser. shows the typical layout of an evaporative condenser.

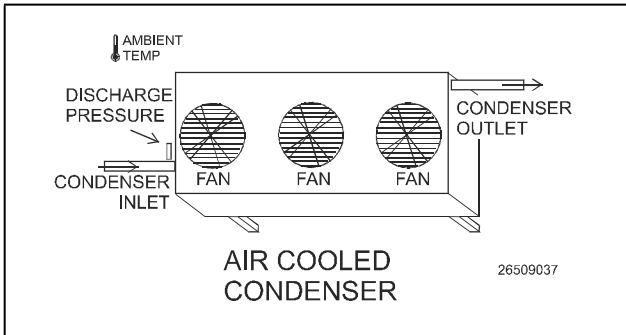

Figure 9-23 - Air Cooled Condenser Diagram

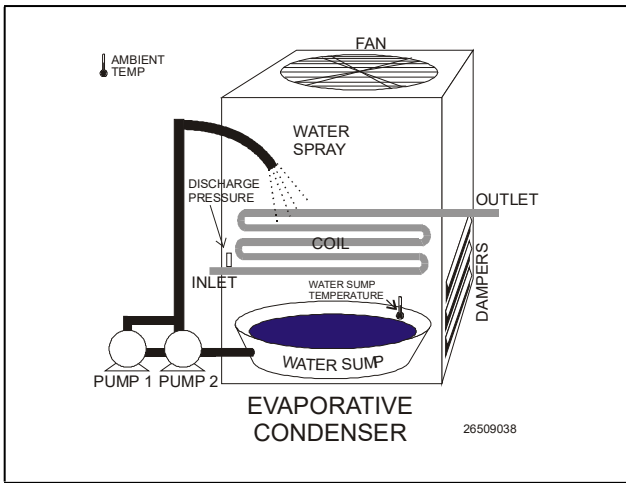

Figure 9-24 - Evaporative Condenser Diagram

| Input | Sensor Type |
|------------------------------------|----------------------------|
| Discharge Pressure | 500 lb. Eclipse transducer |
| Ambient Temp | Temperature |
| Water Sump Temp (Evap. only) | Temperature (Immersion) |
| Override Temp Sensors (Evap. only) | Temperature (Pipe-Mount) |

9.37 Standard Circuits

Refrigerated cases that do not use case controllers are controlled by Standard Circuit applications. In a Standard Circuit application, the Supervisory Controller is responsible for all case monitoring and control; it uses the RS485 I/O Network to both gather case temperature inputs and activate or deactivate the liquid line solenoids, defrost modes, and fans. Also, circuits that use ESRs and MultiFlex ESRs are controlled using Standard Circuits.



NOTE: Do not set up a Standard Circuit application for a case that uses a CC-100 or CCB case controller. These cases must use Case Circuit Control applications.

The Standard Circuits application provides supervisory control of controllers. It keeps the temperature setpoint and other basic configuration parameters synchronized across all associated devices.

How To Add a Standard Circuits Device on the Supervisory Controller:

1. From the Home screen, navigate to Main Menu> Summaries and Floor Plans> Site Summaries> Refrigeration, click the screen drop-down arrow on the upper right of the screen, click Add Controls.
2. Select the Control or Application Type - Circuits (Standard), enter the Quantity, Control Name and Serial Type. Note that Serial Type information can be enter later. Click Save to add the application.
3. A Confirmation box will appear saying that the application is successfully added to the system, click Close or Edit these controls.
4. The system will display the new application(s) on the Site Summary screen.
5. Click the Standard Circuits application panel box to view the application.
6. The system will display the Standard Circuits application parameters.
7. The user can view and configure the properties of the application by setting the Edit Mode to ON on the screen drop-down arrow on the upper right of the screen.

Licensing:

The maximum number of Standard Circuit applications that can be licensed is 48.

Open Associations

The following applications can be associated with Standard Circuits:

- MultiFlex ESR
- Control Link CD
- XR75CD
- XR35CD

9.38 Case Control Circuits

9.38.1 Overview

Case circuits that use CC-100s, CS-100s, EC-2s, or CCBs for case control rely on Case Circuit Control applications in the Supervisory Controller to provide them the necessary setpoints, defrost scheduling, and other control parameters. Unlike Standard Circuit applications, Case Control Circuits do not directly control temperature in the case circuits; instead, the case controller controls temperature for each individual case based on the setpoint(s) supplied to them by their associated Site Supervisors.

Setup of a case-controlled refrigerated case system is a two-fold process:

1. For each case circuit in the refrigeration system, a separate Case Control Circuit application is created with its own set of control parameters.
2. Each CC-100, CS-100, EC-2, and CCB is associated with a Case Control Circuit application in the Supervisory Controller. Association creates a network link between the case controller and the application which supplies the information necessary to control temperature, defrost, lights, fans, and anti-sweat heaters.

This section of the manual covers both the programming of a Case Circuit Control application and the process of associating a CC-100, CS-100, EC-2, or CCB with a Case Circuit Control application.

9.38.2 Case Circuit Control Software Overview

There are six different versions of case control software in the Copeland case control family:

- **CC-100P** - This version controls temperature in a case using a pulse modulated valve, which is pulsed ON for a percentage of a fixed amount of time to achieve the necessary refrigerant flow.

- **CC-100LS** - This version controls temperature in a case using a liquid-side stepper valve. This valve is capable of various positions in between 0% and 100%. As a result, the CC-100 is capable of supplying the exact refrigerant flow necessary to achieve the case setpoint.
- **CC-100H** - This version controls temperature in a case using a suction-side evaporator pressure regulator (EEPR). This valve is capable of various positions in between 0% and 100%. As a result, the CC-100 is capable of providing the exact suction pressure necessary to achieve the case setpoint.
- **CS-100** - This controller uses suction-side evaporator suction regulators (ESRs) to control suction pressure for an entire circuit. Unlike the CC-100, which controls only one case, the CS-100 controls all cases on an entire circuit.
- **EC-2s** - The EC-2 is a liquid-side pulse valve case controller that doubles as a case temperature and information display. Unlike the CC-100, it is designed to be mounted on the front of the case, and has a push-button front panel interface for programming and viewing status. (The EC-2 29x version controls the refrigeration solenoid valve to allow the passage of refrigerant to the TXV valve, whereas the 39x version controls a pulse valve on the liquid side of the evaporator to regulate superheat.)
- **CCBs** - An I/O Network-based controller used primarily in old RMCC installations. Like the CC-100 family, the CCB was available in several different models that controlled liquid pulse, liquid stepper, suction stepper, and suction lineup.



NOTE: There are several variations of the EC-2. Contact Copeland at 833-409-7505 for more information.

9.38.2.1 Valve Control

The CC-100 is capable of supporting two types of valves: pulse and stepper. The CC-100 uses PID control to vary the aperture rates of both valves between 0% and 100% as required by their temperature control algorithms (see **Section 9.38.3**, below).

Pulse Valves

A pulse valve is a device capable of being in only two states: fully open or fully closed. To achieve the necessary percentage of refrigerant flow, CC-100s repeatedly “pulse” these valves open for a percentage of an interval called the valve period (which defaults to six seconds).

For example, to achieve a 20% valve output in a CC-100

with a valve period of six seconds, a pulse valve would be opened for 20% of six seconds (or 1.2 seconds) and closed for the remaining 80% of the valve period (4.6 seconds). This same six-second sequence will repeat for as long as the CC-100 calls for a 20% valve output.

Stepper Valves

Stepper valves are devices that may be opened to many different positions between fully closed (0%) and fully open (100%). Stepper valves usually have hundreds or thousands of “steps” in between fully closed and fully open. To achieve the desired opening percentage, the CC-100 moves the valve the required number of steps.

To properly control a stepper valve, the CC-100 must know the operating characteristics of the valve, such as its maximum steps per second change rate, the total number of steps between 0% and 100%, and its hysteresis rate (the number of steps required for the valve to change direction).

9.38.3 Refrigeration Control

9.38.3.1 EEVs (Liquid Pulse and Liquid Stepper)

In CC-100P, CC-100LS, EC2, and CCB (liquid and pulse stepper) case controllers, there are two different control systems that work together to regulate refrigeration: temperature control and superheat control.

Temperature Control

Temperature Control measures the case temperature and turns refrigeration ON or OFF as required to keep the case within a certain proximity of the user-specified temperature setpoint.

The user supplies Temperature Control with the setpoint and a deadband, which is the range of case temperatures equally above and below the setpoint within which the case temperature will be considered acceptable. When the case temperature is above the setpoint plus one-half the deadband, refrigeration will be turned ON. It will remain ON until the temperature drops to below the temperature setpoint minus one-half the deadband, at which point refrigerant flow will be turned OFF.

Case temperature may be supplied to Temperature Control by a supply air sensor, a return air sensor, or a mixture of both the supply and return air sensor values.

Temperature Control itself does not vary the opening percentage of the pulse or stepper valve; it simply addresses the case’s need for refrigerant flow to maintain its setpoint. Once refrigeration is started, control of the valve is handled by Superheat Control.

Superheat Control

The difference between the temperature of the refrigerant going in to the evaporator inlet (the coil in temperature) and the refrigerant leaving the evaporator outlet (the coil out temperature) is called Superheat. When refrigerant is flowing through an evaporator, Superheat Control uses PID Control to keep the Superheat at a user-defined Superheat setpoint. Superheat Control positions the valve to increase or decrease refrigerant flow in an effort to keep the Superheat equal to a user-defined Superheat setpoint.

Recovery Mode

Recovery Mode is a special part of Superheat Control that occurs at the beginning of every refrigeration cycle. When refrigeration has been OFF and Temperature Control calls for refrigeration to be ON, a Recovery Mode begins, during which the valve is fixed to a user-defined percentage (usually 70%) for a fixed amount of time. This floods the previously empty evaporator with refrigerant and gradually establishes a differential between the coil in and coil out temperatures. When the Recovery Mode ends, the superheat will be relatively close to the setpoint; at this time, Superheat Control will begin.

Recovery Mode always lasts for a specific number of seconds. The case controller determines the duration based on past performance of the evaporator during previous Recovery Modes.

Thermostatic Expansion Valves (TXVs)

As an alternative to regulating superheat using EEVs, case controllers also support cases that use mechanical thermostatic expansion valves (TXVs). When TXVs are being used, the case controllers use only Temperature Control to turn refrigeration ON and OFF. Superheat Control is disabled, since it is assumed the TXV is taking care of the superheat.

9.38.3.2 EEPRs (Suction Stepper)

The CC-100H, CS-100, and CCB (suction stepper and lineup) control case temperature from the suction side of the evaporator by using an EEPR to regulate suction pressure.

Suction-side control differs from liquid-side control in that Superheat Control is not used. In liquid-side control, the valve aperture is controlled in order to achieve a superheat setpoint. In suction-side control, the CC-100 changes the valve aperture to achieve the case temperature setpoint.

Case temperature may be supplied by a supply air sensor, return air sensor, or a mixture of the two values.

Temperature Control uses PID control to operate the valve and keep the case temperature input value equal to the case temperature setpoint.

Recovery Mode

Recovery Mode for suction-side case controllers is slightly different than Recovery Mode for liquid-side controllers. Suction-side case controllers enter Recovery Mode only after a defrost or cleaning cycle, and it does so in order to bring the case temperature down to a level that is controllable by Temperature Control.

During Recovery Mode, the valve is opened to a fixed percentage until the case temperature falls below the case setpoint. When this occurs, the case controller exits Recovery Mode and begins normal Temperature Control.

9.38.4 Defrost Control

The physical aspects of defrost control, such as shutting off valves and turning on defrost heat sources, is handled by the case controller. When operating on its own, a case controller initiates defrost cycles at programmed time intervals. When connected to a Case Circuit application, the case controllers' defrost times are coordinated and scheduled by the Supervisory Controller.

9.38.4.1 Defrost States

The defrost cycle for a Case Circuit application consists of three steps. Of these three, steps #1 and #3 apply only to cases with heated defrosts:

1. **Pump Down** - The defrost cycle begins with this step immediately after the refrigeration solenoid is turned OFF. During the Pump Down phase, the application waits for a user-specific amount of time to elapse before turning on the defrost heat. This allows refrigerant in the evaporator to be evacuated before defrost heat is activated. The compressor(s) remain ON during Pump Down. *Pump Down times may only be used for hot gas and electric type defrosts.*
2. **Defrost** - During the defrost phase, refrigeration is disabled. If using electric defrost heaters will be ON. If using hot gas, heated refrigerant will be pumped through the coil. This phase will continue until the defrost is terminated.
3. **Run-Off** - After defrost heat is deactivated, the application waits for the Run-Off time to pass before re-entering refrigeration mode. This allows melted frost on the evaporator to drain from the coil so that it will not re-freeze when refrigeration begins again. After the user-specified Run-Off time has passed, the defrost cycle has ended. *Run-Off times may only be programmed for hot gas and electric type defrosts.*

9.38.4.2 Defrost Types

There are many different ways used to defrost a refrigerated case. A case controller is capable of using three different types of defrost.

Off Cycle (Timed)

Off Cycle defrost (also known as Timed defrost) is simply a period of time during which refrigeration is suspended. No heat is applied to the evaporator. The application simply turns refrigerant flow OFF for the duration of the defrost cycle.

When these defrost types are used, Pump Down and Run-Off times are not necessary; therefore, they will not be part of the defrost cycle.

Hot Gas and Reversed Cycle Hot Gas

Hot Gas and Reversed Cycle Hot Gas require the use of hot gas from the refrigeration lines. During these types of defrost, the application will open the valve and pump heated refrigerant through the evaporator coil. Any user-defined Pump Down and Run-Off times will be observed as normal.

Electric Defrost

Electric defrost uses electric heaters to defrost the evaporator coil. During electric defrost, the application will turn the Defrost output ON, which will likewise activate the heaters connected to the power module's defrost relay.

Any user-defined Pump Down and Run-Off times will be observed as normal.

9.38.4.3 Defrost Termination

Both the start time and the end time of a defrost cycle are determined by the user. The Pump Down, Defrost, and Run-Off stages all have fixed durations, and when the last stage of the cycle is complete, defrost is terminated.

However, a case controller may be programmed to terminate the Defrost stage of the defrost cycle early if the temperature inside the case rises above a fail-safe temperature setpoint. For certain defrost types, defrost heat may also be "pulsed" in order to keep the temperature below the setpoint without terminating defrost.

Temperature Termination

One or more temperature sensors in the case circuit may be designated as termination temperature sensors. The values of these sensors are combined into a single control value, and this value is compared to the setpoint. If the termination control value is greater than the user-defined setpoint, defrost will end, and the defrost cycle will begin the Run-Off period (if applicable).

Termination sensors may be either analog temperature sensors or digital closures (Klixons). Also, Case Circuit applications may use the value of the analog case temperature sensors for use in temperature termination.

Pulsed Defrost

Pulsed Defrost is only available if the circuit is using Electric or Hot Gas defrost.

Pulsed Defrost is similar to Temperature Termination, except when the termination temperature rises above the setpoint, defrost does not terminate. Instead, the output that applies defrost heat is turned OFF. The output will remain OFF until the temperature falls below the setpoint, at which time the output will come back ON.

The Case Circuit application will continue to pulse defrost in this manner until the defrost time has passed. The defrost cycle will then begin the Run-Off period.

9.38.4.4 Demand Defrost

If a case is configured with a demand defrost sensor, a case controller may use their inputs as a means of keeping scheduled defrost cycles from occurring when frost levels are not high enough to require a defrost.

The optical demand defrost sensor may be either an analog or digital type sensor. When this sensor detects no major build-up of frost, the Case Circuit application ignores all scheduled calls for defrost and continues in refrigeration mode. When the sensor detects frost, the defrost inhibit is canceled, and the case circuit will enter defrost at the next scheduled time.

A demand defrost inhibit only keeps scheduled defrosts from occurring. Any manual calls for a defrost cycle will occur as normal. CCB demand defrost is currently not supported in the Supervisory Controller. Demand sensors, if present on the circuit, will be ignored.

Demand Fail-Safe Time

To protect against demand defrost sensors that may not be working properly, a demand fail-safe time may be set up. Demand fail-safe times limit the amount of time a defrost inhibit may last. If a demand defrost sensor does not detect frost for an amount of time equal to the Demand Fail-Safe Time, the defrost inhibit is lifted and the circuit will enter defrost at the next scheduled time.

9.38.4.5 Emergency Defrost

When necessary, a user can initiate an emergency defrost cycle from a circuit. Emergency defrost cycles are similar to normal defrost cycles, except an emergency defrost cycle will ignore all calls for termination and remain in defrost for the entire programmed defrost time.

- Emergency defrosts are initiated by the user.
- The WAIT State

When a Case Control Circuit application enters defrost mode, it sends a message out to all case controllers in the circuit to begin defrost at the same time. However, since each case in a circuit will have its own termination sensors, it is possible for some cases to terminate defrost while defrosts in other cases continue.

When a case controller terminates defrost, it enters a state of operation called "the WAIT state." While in the WAIT state, all refrigeration and defrost heat will remain OFF. When the Case Control Circuit application detects that all case controllers have entered the WAIT state, the application will consider the defrost cycle completed, and refrigeration will restart.

9.38.4.6 Defrost Schedule Summaries

The Defrost Schedule Summary allows users to view all scheduled defrosts on one screen and identify possible overlaps before potential performance issues could be caused in the system. When a case circuit is added and a case type is selected, a defrost schedule will be assigned for that circuit based on the case type. When another case circuit and case type are added, another defrost schedule is added based on the case type. Staggering defrost intervals are automatically started for the second circuit after the first circuit schedule starts in order to reduce peak consumption of energy and balance refrigeration and electrical load.

9.39 Irrigation Control

Irrigation control is an application used for the controlling of sprinkler systems. This application controls watering by duration of time or water usage parameters. Days of the week and times for watering are set by the user with a maximum of two Irrigation applications allowed in the CX controller.

The master water valve is turned ON and OFF as water is needed for a zone. When disabled, no application control of any outputs will be possible and the System Status output will indicate Disabled.

Under normal control only one zone will be active at a time.

How To Add a Irrigation Control Device on the Supervisor:

1. From the Home screen, click the Control Inventory icon (box). Click the drop-down arrow for Add Control in the appropriate category and select from the list.
2. Select the Control or Application Type - Irrigation Control, enter the Quantity, Control Name and Serial Type. Note that Serial Type information can be enter later. Click Save to add the application.

3. A Confirmation box will appear saying that the application is successfully added to the system, click Close or Edit these controls.
4. The system will display the new application(s) on the Site Summary screen.
5. Click the Irrigation Control application panel box to view the application.
6. The system will display the Irrigation Control application parameters.
7. The user can view and configure the properties of the application by setting the Edit Mode to ON on the screen drop-down arrow on the upper right of the screen.

| Application Advisories | Heating |
|------------------------|--------------|
| Flow obstructed | Non-critical |
| Leak detected | Non-critical |
| Inhibit Sensor Failed | Non-critical |

Table 9-23- Irrigation Control Advisories

9.40 TD Control

9.40.1 Overview

The TD Control application controls fans sequentially based on the temperature differential (TD) of the condenser. When an increase is called for, the next fan will turn on when the time since the last fan state change is greater than the Fan On Delay Time setpoint (or will turn on immediately if the last change was more than the Fan On Delay). Additional fans will be staged on at Fan On Delay intervals while an increase in capacity is called for. When a decrease is called for, the next fan will stage off when the time since the last fan state change is greater than the Fan Off Delay Time setpoint (or will turn off immediately if the last change was more than Fan Off Delay). Additional fans will be staged off at Fan Off Delay intervals while a decrease in capacity is called for.

9.40.2 Temperature Differential (TD) Strategy

TD strategy attempts to maintain a constant difference (i.e., TD setpoint) between the temperature of the refrigerant and the ambient temperature. The TD setpoint allows you to set the constant that is to be maintained.

TD strategy uses drop leg temperature for the refrigerant temperature and plenum temperature for the ambient temperature. The formula for determining the TD control value is:

$$TD = (\text{dropleg temp}) + (\text{dropleg offset*}) - \text{plenum temp.}$$

* DropLeg Offset is a user-configured parameter to allow fine-tuning of the drop leg temperature measurement.

In TD condenser control operation, when the TD rises above $TD \text{ setpoint} + (TD \text{ deadband} / 2)$, an increase in fan capacity is called for. Similarly, when the TD drops below $TD \text{ setpoint} - (TD \text{ deadband} / 2)$, a decrease in fan capacity is called for. TD can control up to four condenser fans.

9.40.3 TD Control Fail-Safes

TD Control operates as long as plenum and drop leg temperature inputs are available and the drop leg temperature remains within a minimum/maximum range configured by the user. Otherwise, TD control uses various fail-safe modes to control the condenser fans.

In the event drop leg temperature is not available (due to probe failure), all fans will be staged on.

Drop Leg Temperature Above Maximum Drop Leg Setpoint

If the Drop Leg temperature (Drop Leg Temp) rises above the maximum drop leg temperature setpoint (Drop Leg Max), an increase will be called for until Drop Leg Temp drops below Drop Leg Max. This protects against the possibility of the Drop Leg Temp rising too high as a result of high plenum temperature.

Drop Leg Temperature Below Minimum Drop Leg Setpoint

If the Drop Leg temperature drops below the minimum drop leg temperature setpoint (Drop Leg Min) a decrease will be called for until Drop Leg Temp rises above Drop Leg Min. This protects against the possibility of the Drop Leg Temp falling too low as a result of low plenum temperature.

Plenum Temperature Not Available

If plenum temperature is not available (due to probe or communication failure), control will be based on the Drop Leg Min and Max setpoints.

9.40.4 Configuration

TD Control allows the user to operate a condenser at its designed temperature differential and saves energy by maintaining optimal condenser TD with the least amount of fans on as possible.

Standard discharge pressure control may attempt to operate the condenser below its designed TD and turn on more fans than necessary.

Set the number of condenser fans to be controlled in the Num Cond Fans field under Setup (4 is the default value).

9.40.5 Setpoints

TD setpoints are configured to allow control of the condenser at its designed TD during swings in ambient temperature.

For the Drop Leg Minimum setpoint, if the drop leg temperature falls below this setpoint, condenser fans will be cycled OFF regardless of the value of the TD setpoint.

For the Drop Leg Maximum setpoint, it is the maximum allowable value of the drop leg temperature. If the drop leg temperature rises above this setpoint, the condenser fans are cycled ON regardless of the value of the TD.

The Drop Leg Offset setpoint is an adjustment entered, if needed, after measuring liquid subcooling during operation of an individual condensing unit.

The TD setpoint is the optimal difference between the refrigerant drop leg temperature and the ambient (plenum) temperature. When the TD (i.e., *drop leg temp + drop leg offset - plenum temp*) begins to climb above this setpoint, fans will be cycled ON to bring down the drop leg temperature, thus lowering the TD measurement.

The TD deadband setpoint is a range of values around the TD Setpoint within which the value of the TD calculation is acceptable. When the TD rises above the setpoint plus 1/2 the deadband value, fans will begin cycling ON. When the TD falls below the setpoint minus 1/2 the deadband value, fans will cycle OFF.

For the Condenser Fan On Delay setpoint, fans are cycled ON when the TD is above the setpoint at the rate set for Condenser Fan On Delay. For example, if this field is set to 30 seconds, each fan is staged ON in 30-second intervals until all fans are ON, or until the TD falls back below the setpoint.

For the Condenser Fan Off Delay setpoint, fans are cycled OFF when the TD is below the setpoint at the rate set for Condenser Fan Off Delay. In other words, if this field is set to 30 seconds, each fan is staged OFF in 30-second intervals until all fans are OFF, or until the TD rises back above the setpoint.

9.40.6 Inputs

The Drop Leg Temperature input is the current drop leg temperature used for TD control.

The Plenum Temperature input provides the current value of the ambient temperature used for TD calculation.

9.40.7 Alarms

For Drop Leg High alarm, the alarm setpoint is the drop leg temperature that, if exceeded, will cause an alarm to be generated. If you wish to generate an alarm for high drop leg temperature, enter the desired setpoint. Otherwise, to disable this alarm, leave the value set to NONE.

For Drop Leg Delay, if the drop leg alarming feature is used, enter the amount of time the drop leg temperature must be higher than the setpoint before an alarm will be generated (HHH:MM).

For TD High alarm, the TD alarm setpoint is the value of the TD calculation that, if exceeded, will cause an alarm to be generated. If you wish to generate an alarm for high TD, enter the desired setpoint. Otherwise, to disable this alarm, leave the value set to NONE.

For TD Delay, if the TD alarming feature is used, enter the amount of time the TD must be higher than the setpoint before an alarm will be generated (HHH:MM)

9.41 Loop/Sequence Control

The Loop Sequence Control application's main function is to read the value of an analog input, compare the value to a setpoint, and generate a single analog output value. This output value is represented in three different forms: a single analog value from 0% to 100%, up to eight digital stage outputs, and a digital pulse width modulation output.

The output value(s) are generated by a PID Control cell, which takes into account both the input's instantaneous value and its rate and direction of change. The PID Control algorithm is similar to the PID algorithm used by Pressure Control, except the Loop Sequence Control application is designed to be used in a wider array of applications.

How To Add a Loop/Sequence Control Device on the Supervisor:

1. From the Home screen, click the Control Inventory icon (box). Click the drop-down arrow for Add Control in the appropriate category and select from the list.
2. Select the Control or Application Type - Loop/Sequence Ctrl, enter the Quantity, Control Name and Serial Type. Note that Serial Type information can be enter later. Click Save to add the application.
3. A Confirmation box will appear saying that the application is successfully added to the system, click Close or Edit these controls.

4. The system will display the new application(s) on the Site Summary screen.
5. Click the Loop/Sequence Control application panel box to view the application.
6. The system will display the Loop/Sequence Control application parameters.
7. The user can view and configure the properties of the application by setting the Edit Mode to ON on the screen drop-down arrow on the upper right of the screen.

9.42 Modular Chiller Control

The Modular Chiller Control is available for the Supervisory Controller version 2.12 and above.

A Modular Chiller Control is made up of a single compressor connected to a brazed plate heat exchanger that provides a chilled water and glycol mixture for cooling display cases and coolers. Multiple Modular Chillers are connected together to meet the capacity requirements of the system.

Modular Chillers are designed to provide cooling by paralleling the hydronics side of the secondary system instead of the refrigeration side of the system. These units also use a water and glycol mixture as a condensing fluid for compressor heat of rejection. This design eliminates the long refrigerant piping runs thereby significantly reducing refrigerant charge.

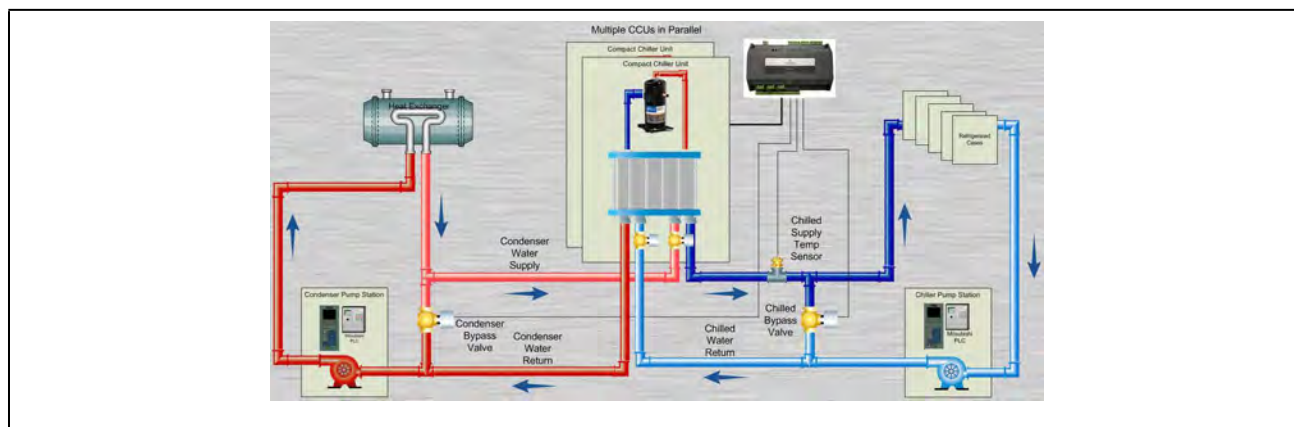

Figure 9-25 - Compact Chiller System

9.42.1 Learning Mode

When the application runs for the first time, it undergoes a "Learning Mode" period to collect data on the chiller stages. During Learning Mode, Modular Chiller Control will control the chilled water temperature, but it will purposely cycle the chiller stages in different combinations to measure the effect they have on the temperature input value.

The Learning Mode lasts for several minutes. After Learning Mode ends, the Modular Chiller will require up to 24 hours of operation before compressor cycling is operating at maximum efficiency. If compressor cycling seems too frequent after 24 hours of operation, you may reduce compressor cycling by changing the Control/Cycles parameter.

9.42.2 The Control/Cycles Parameter

The Modular Chiller Control has one parameter with five preset settings to allow users to alter temperature control performance or compressor cycling frequency. The default setting, "Moderate Control," seeks to balance good temperature control with efficient cycling. If tighter control is needed, setting the field to "Tight Control" or "Tightest Control" will increase the application's reaction to temperature changes, resulting in tighter control (usually at the expense of more frequent cycling). If fewer compressor cycles are desired, setting the field to "Less Cycling" or "Least Cycling" will decrease the number of cycles but also increase the amount of fluctuation in the temperature control.

9.42.3 Compressor Control

Modular Chiller Control can utilize up to 32 compressors for maintaining the chilled supply temperature at a user specified setpoint. This is accomplished by either turning on or off any of the compressors defined in the application. As Supply Temperature rises above setpoint, compressors will be turned ON. As Supply Temperature falls below setpoint, compressors will be turned OFF. The Chilled Supply Temperature sensor should be located very close to the Compressor Control Unit so no minimal control lag is expected to be present.

When a compressor has been shut down on an alarm, the compressor will remain out of the active rotation until the alarm has been cleared. Additionally, the user will have the option of specifying that the alarmed compressor be re-tried the next time it comes up in the rotation. To prevent damage to a compressor, the user will have the option of specifying a number of trips per day before the compressor is permanently locked out. Once this condition has occurred, the compressor alarm will require a manual reset to bring it back into the active rotation.

The controller will monitor the Chilled Differential Pressure and if it falls below a user specified threshold, the controller will start to shut down compressors one at a time based on a user specified time delay. This shutdown operation will be suspended if the Chilled Differential Pressure rises above a user defined setpoint.

9.42.3.1 Digital Scroll Compressor

Modular Chiller Control can also utilize a single Digital Scroll Compressor. The assumption is that one of the Compressor Control Modules in the system may have a digital scroll instead of a standard scroll compressor installed. The Digital Scroll Compressor may not be the same size as the fixed scroll compressors. When a Digital Scroll Compressor is defined in the application, Modular Chiller will utilize the compressor control modules with the digital scroll at all times, modulating the capacity of the compressor to maintain the Chilled Supply Temperature setpoint. All other compressor control modules will be turned ON or OFF based on the rotation sequence defined above. Based on this strategy, the digital scroll compressor will have the fewest cycle counts and the most runtime of all the compressors in the system.

9.42.3.2 Variable Frequency Drive Compressor

Modular Chiller can utilize one compressor with a variable frequency drive. The method of control will be similar to the digital compressor strategy. The application will continue to allow only one variable capacity device to be defined in the system, making the Variable Frequency Drive and Digital compressor options mutually exclusive.

If a Variable Frequency Drive compressor is to be used and it is a Control Techniques drive using the Modbus communication interface, the Control Techniques Drive association menu will support associating the drive to an Modular Chiller.

9.42.3.3 Unequal Capacity Compressors

Optionally, Modular Chiller Control can support different capacity compressors. When this option is selected, the capacity of each defined compressor will be user specified. The controller will evaluate the capacities of all the compressors to determine the appropriate compressor to switch on or off in order to maintain the Supply Temperature at setpoint.

When unequal capacity compressors are defined, the controller will not use a simple round robin approach to switching compressors on or off (as with equal capacity compressors) and therefore compressor runtimes may vary significantly over time. However, for those compressors defined with identical capacity, the algorithm will attempt to keep both runtimes and cycle counts as even as possible.

9.42.4 Bypass Valve Control

Modular Chiller Control can utilize the Chilled and Condenser Bypass Valves. These valves will be modulated to maintain user defined differential setpoints. For each valve, as the differential pressure rises above the setpoint, the valve will modulate open. When the differential pressure falls below setpoint, the valve will modulate closed.

9.43 XM Circuit Control

The XM Circuit Control application is an application that provides supervisory control over the XM series of case controllers. Although the XM case controllers can also be controlled by the Case Control Circuit application in the Supervisory Controller, specific configuration parameters in the Case Control application apply and synchronize only with CC-100, CS-100, and CCB case controllers. The XM Circuit Control application is specifically designed to support XM controllers and its parameters, and does not support other types of case controllers.

The Supervisory Controller also supports sharing all XM temp input alarms with the XM Circuit. Users can configure and receive a temperature alarm in the XM Circuit.

This section of the manual covers both the programming of an XM Circuit application and the process of associating an XM670, XM678, or XM679 with an XM Circuit application.

9.43.1 Associations

Case circuits that use XM670, XM678, or XM679 for case control rely on the XM Circuit Control application in the Supervisory Controller to provide them the necessary setpoints, defrost scheduling, and other control parameters. XM Circuits do not directly control temperature in the case circuits; instead, the case controller controls temperature for each individual case based on the setpoint(s) supplied to them by their associated XM Circuit.

Setup of a case-controlled refrigerated case system is a two-fold process:

1. For each case circuit in the refrigeration system, a separate XM Circuit application is created with its own set of control parameters.
2. Each XM670, XM678, and XM679 is associated with an XM Circuit application in the Supervisory Controller. Association creates a network link between the case controller and the application which supplies the information necessary to control temperature, defrost, lights, fans, and anti-sweat heaters.

Condenser Control, Case Control, XM Circuits or Suction Groups with complex associations can be easily added under the Control Programming Menu where a window with additional association options will appear.

9.43.1.1 Case Circuit Association Support

The XM series of case controllers can be associated with either an XM Circuit application or an existing Case Circuit application. This allows users to upgrade the Supervisory Controller firmware without the need of any re-programming of XM controller associations. However, the Case Circuit application provides a limited functionality for any XM controller. For full circuit functionality, it is recommended that the XM controllers be associated with the XM Circuit application.

9.43.1.2 Dual Association Not Supported

Once an XM case controller is associated to a circuit (either an XM Circuit or a Case Circuit), it can no longer be associated with any other circuit.

For example, if an XM controller is associated with a Case Circuit application, it will not be available in the XM Circuit association screen. Once the Case Circuit association is removed, the XM controller will then be available on the XM Circuit association screen.

9.43.1.3 Synchronized Parameters

The following XM Circuit parameters are synchronized to any associated XM case controllers:

| | |
|------------------|-------------------|
| Fan Mode | Case Alarm LO |
| Defrost Type | Case Alarm DLY |
| Pump Down Delay | Case Alarm Prior |
| Defr Duration | Case Alarm Cfg |
| Drip Time | Case Alm Hi Type |
| Term Temp SP | Case Alm Lo Type |
| Stand Alone Time | DLY After Defrost |
| Case Alarm HI | |

Table 9-24 - Synchronized parameters

The XM Circuit application does not use these parameters in any internal logic within the circuit and the values of these parameters are only synchronized with any associated XM case controllers.

9.43.1.4 Visibility of Associated Parameters

All existing XM controllers integrated in the Supervisory Controller (for example, XM678) are modified to support conditional visibility on parameters that are associated to the XM Circuit. If an XM controller is associated with an XM circuit, the XM controller application will hide the associated parameters. If the XM controller application is not associated to an XM Circuit application, all of its parameters will be visible.

9.43.2 Suction Group Interaction

Circuits have specific interaction with suction groups. Similar to the Case Circuit application, the XM Circuit application interacts with both Standard and Enhanced Suction applications.

9.43.2.1 Standard Suction

The XM Circuit can be associated to a standard Suction Group application using the lookup (F4) function while editing the Suction Group parameter.

9.43.2.2 Enhanced Suction

The XM Circuit can be associated to Enhanced Suction Group applications. However, the association to Enhanced Suction groups is performed from within the Enhanced Suction group setup. When editing the Suction Group parameter in the XM Circuit application, only Standard Suction applications will be visible.

9.43.3 Supervisory Control Functions

The XM Circuit application provides supervisory control and coordination of associated case controllers.

9.43.3.1 Dewpoint Value

When a dewpoint sensor is connected to the DEWPOINT input of an XM Circuit application, the value of this sensor will be sent to all associated XM case controllers. The dewpoint value will be used by the XM case controllers to modulate the anti-condensate heater, if equipped.

9.43.3.2 Lighting Control

The value present on the LIGHT SCHEDULE input of the XM Circuit application will be sent to all associated XM case controllers.

Lights During Defrost

If the Lts During Defr is set to ON, the XM case controller lights will follow the schedule connected to the LIGHT SCHEDULE input at all times. However, if Lts During Defr is set to OFF, the XM case controller lights will be turned off during defrost periods, regardless of the LIGHT SCHEDULE input.

9.43.3.3 Active Setpoint Output

When the USE DUAL STPT input is OFF, the XM Circuit will use the Case Temp Stpt parameter as the active case setpoint, which means the value of Case Temp Stpt will be written to the ACTIVE SETPT output.

When the USE DUAL STPT input is ON, the XM Circuit will switch over to using the "Dual Temp Stpt" parameter as the active case setpoint, which means the value of Dual Temp Stpt will be written to the ACTIVE SETPT output. All associated XM case controllers will use the ACTIVE SETPT from the XM Circuit as the current case temperature setpoint.

Demand Setpoint Bump

If the PRI DEMAND SHED input is ON, the active setpoint will be adjusted by the amount specified by the Pri Demand Bump parameter.

If the SEC DEMAND SHED input is ON, the active setpoint will be adjusted by the amount specified by the Sec Demand Bump parameter.

If both the PRI DEMAND SHED and SEC DEMAND SHED inputs are ON, the SEC DEMAND SHED will take priority.

9.43.3.4 Defrost Scheduling

The XM Circuit application provides defrost scheduling to the associated XM case controllers.

Defrost Start Mode

Defrosts may be initiated with one of the following methods - Numbered or Scheduled.

- Numbered - the starting time of the first defrost (called Reference Time) is defined by the user and all the subsequent defrosts are equally spaced out throughout a 24-hour period. For example, if four defrosts are specified with a reference time of 00:00, the remaining three defrosts will begin at 06:00, 12:00, and 18:00. Up to 24 numbered defrosts may be specified.
- Scheduled - the absolute start time for each defrost is specified by the user. Up to 12 scheduled defrosts may be specified.

Days Between Defrost

The DaysBetweenDfr parameter specifies the number of days to skip scheduled defrosts. This feature is useful for cases that do not require a defrost cycle every day. If set to zero, defrosts will occur every day. If set to one, defrosts will occur every other day. If set to two, defrosts will occur every after two days. The user may specify up to six days to skip defrosts.

9.43.3.5 Case States

The XM Circuit application provides a circuit status output (CASE STATE OUT) to indicate the mode of operation of the circuit.

The XM Circuit application supports the following case states:

| State | Description |
|---------------|--|
| Off | The circuit is shut down. All associated case controllers are neither refrigerating nor defrosting. |
| Refrigeration | The circuit is refrigerating. Most associated case controllers are in the refrigeration state (maintaining case temperature setpoint). |
| Defrost | The circuit is in defrost. Most associated case controllers are in a defrost cycle. (The defrost cycle includes several sub-states, for example, pump down, drip, and more.) |

Table 9-25 - Case States

The XM Circuit application determines the state of each associated case controller by evaluating CASE REFR STA and CASE DEFR STA. Based on the value of these two input properties, one of the three case states listed in **Table 9-25** is selected and written to the corresponding CASE STATE OU output property.

9.43.3.6 Case Type

The Case Type parameter permits the user to select the type of refrigerated case that will be used for the XM Circuit application. Based on this setting, the case temperature setpoint and certain defrost parameters will be set to suitable values.

9.43.4 Application Advisory

The following advisories are generated by the XM Circuit application:

- Combined Case Temperature High/Low
- Product Temperature High/Low
- Defrost did not start

9.43.4.1 Synchronized Alarm Parameters

The XM Circuit application will synchronize the Case Alarm High and Low setpoints with associated XM devices. The circuit will not perform the alarming functionality for Case Temperature as it is handled in each XM device.

Because XM devices support relative and absolute alarming for Case Temperature, the XM Circuit will support the Case Alarm Hi and Case Alarm Lo parameters as either temperature or Δ temperature Engineering Units.

9.43.5 Application Commands

The following application commands will be supported by the XM Circuit application:

9.43.5.1 Start Defrost

When the user selects this command, a defrost cycle is immediately initiated. The START DEFR OUT output will turn ON and will stay ON for the duration specified in the Min Defr Time parameter. If at anytime during this period the user issues a Stop Defrost command, the START DEFR OUT output will immediately turn OFF.



NOTE: The behavior of the START DEFR OUT output is the same whether it is started by the Start Defrost command or by a regularly scheduled defrost.

9.43.5.2 Stop Defrost

When the user selects this command, a defrost cycle is immediately stopped. The STOP DEFR OUT output will turn ON and will stay ON for a period of one minute, and then will switch OFF. If at anytime during this period the user issues a Start Defrost command, the STOP DEFR OUT output will immediately turn OFF.

9.43.5.3 Case Clean Out

Case Clean Out can be enabled from the Cleaning Switch parameter in the Genera tab of the XM Circuit application. Set the mode from the Cleaning Mode parameter and configure Failsafe time settings.

9.43.6 Product Probe Support

The XM Circuit application supports a product probe temperature input for each case controller associated. To enable support for product temperature inputs, set the "En Product Prob" parameter to Yes.

If one or more product probe inputs are used, high and low temperature alarming may be enabled.

9.44 XR75CX Case Display

The XR75CX-Case Display is a microprocessor based controller, suitable for applications on medium or low temperature ventilated refrigeration units. It has up to four (4) analog inputs: discharge air temperature, product temperature, defrost temperature and coil out temperature, four (4) relay outputs, and up to two (2) digital inputs.

9.45 Boiler

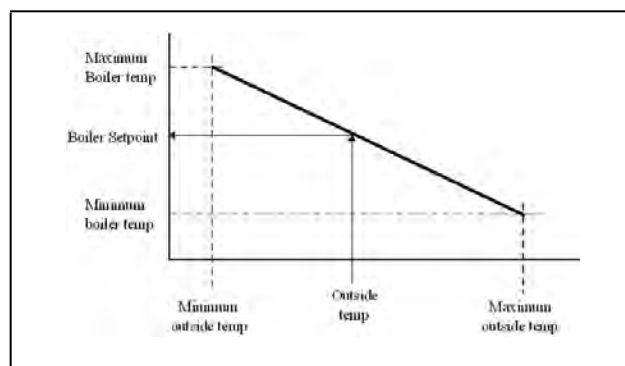

Figure 9-26 - Temperature Ranges

The Boiler can be controlled two ways, via the boiler temperature or the boiler pressure. Current outside air temperature calculates a new boiler control setpoint. If the boiler temperature (or boiler pressure) is less than the setpoint value, the boiler is turned ON. Otherwise it is turned OFF. The algorithm will work in an inverted fashion if the Minimum Outside Air Temperature is

greater than the Maximum Outside Air Temperature. An Outside Air Temperature Boiler On and an Outside Air Temperature Boiler Off can be defined. If the outside air temperature is lower than the Outside Air Temperature Boiler On, the boiler is turned ON. If the outside air temperature is higher than the Outside Air Temperature Boiler Off, the boiler is turned OFF. If defined, the Outside Air Temperature Boiler Off must be greater than the Outside Air Temperature Boiler On.

9.45.1 Boiler Alarms

There are four advisories generated by the Boiler Application:

- High Temperature
- Low Temperature
- High Pressure
- Low Pressure

Each advisory will have an associated type, priority, and delay.

9.46 XJ Condensing Unit

The XJ Condensing Unit is a device for controlling the XJ Condensing Unit, also known as the XJ Scroll Unit. The Supervisory Controller will perform tasks for coordination, logging, alarming, and access for configuration and status. The XJ Scroll Unit follows the typical MODBUS commissioning method. In the XJ Scroll Unit, the device address is determined using dip switches on the device itself. The range of allowable addresses is 1 through 255.

Copeland Scroll™ outdoor condensing units provide scroll compressor technology with advanced diagnostic controls to ensure reliable performance and operation in food service applications. Protection and diagnostic features are controlled by an electronic integrated control board. This control board provides base control functions related to temperature controller, defrost,

Setting up a Pressure Transducer

Note: This applies to both Onboard IO and IPX.

1. Configure ConfProbeX to 0 - 5V and Set ConfX Linear to On. Press **Save**.

| POINT NAME | VALUE | UNIT |
|------------------|-------------|------|
| ConfProbe1 | 0-5V | |
| Conf01_Linear_EU | Temperature | |
| Conf01_Offset | 0.00 | °F |
| Conf01_Linear | ON | |

evaporator fan control, compressor protection (for example, current overload, phase reversal, liquid/vapor injection control, self diagnostics and warnings). These error codes can be seen by an LED display for troubleshooting and maintenance. Medium and low temperature units are available in single and three phase 208/230 volts. The -002 and -012 BOM product is approved for operation in ambients from 120°F to -10°F. For more information, refer to the Copeland Scroll™ Outdoor Condensing Unit literature P/N AE5-1377 R3.

9.47 CAN Bus - IPX (Expansion Module)



Figure 9-27 - Can Bus Expansion Module

The IPX boards provide expansion I/O for the Supervisor.

Pulsing logic is now supported. When selecting Digital, the relay works as normal. When Pulse is selected, relay pulsing logic is applied. The relay will cycle periodically (turns ON and keeps ON for a specified period of time), and the CfgRL0x Period; CfgRL0x_OnTime parameters become available.

For the CfgRL01 OnTime parameter, when Pulse is selected, this parameter specifies the duty cycle (the ON percentage of the cycle period with a range from 0 to 100%). For the CfgRL01 Period parameter, when Pulse is selected, this parameter specifies the entire cycle period.

2. Select Pressure for the ConfX Linear EU. Press **Save**.

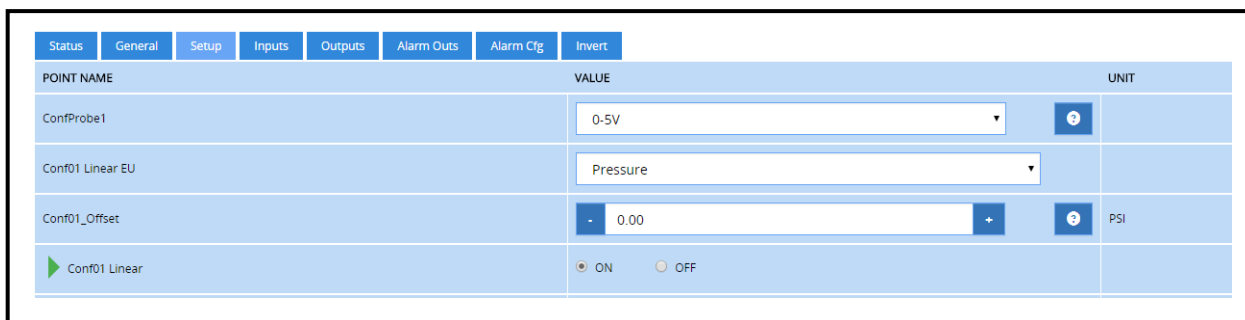

3. Fill in the appropriate configuration values (Example, for a 100 psi Transducer)

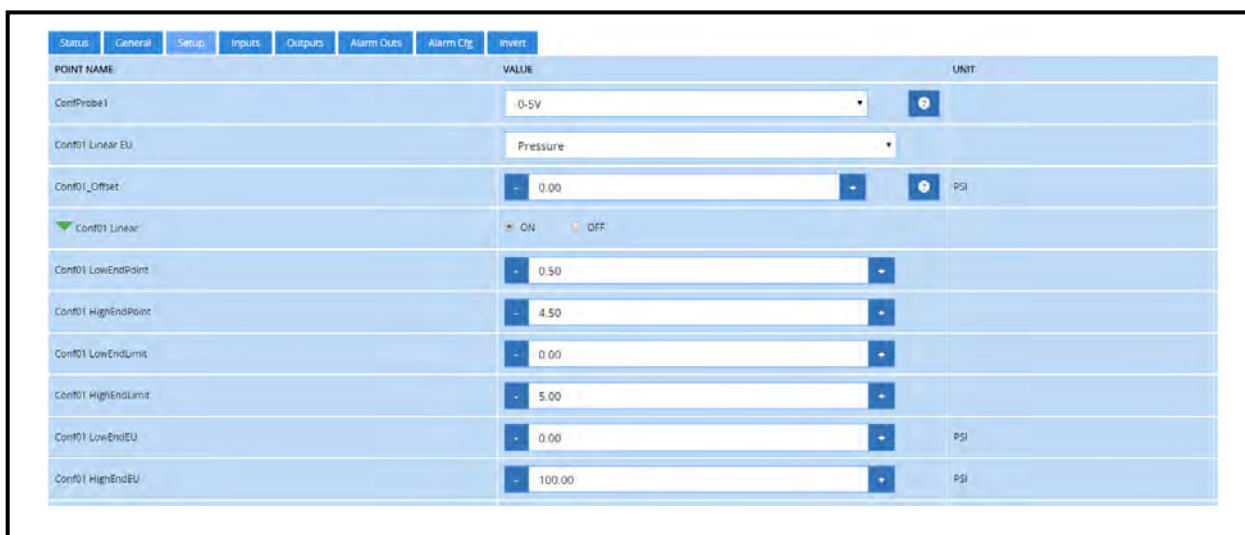

9.47.1 IPX 6 Relay

The IPX 6 board provides expansion I/O for the Supervisory Controller.

Configurations and Specifications of IPX Devices:

| Name | HW Format | Analog Inputs | Digital Inputs | Relays | Analog Outputs | Connector Types | Part Number |
|--------------------|------------|---------------|----------------|--------|----------------|--------------------------------|----------------------|
| IPX106D IPX206D | 4 DIN Rail | 7 | 3 | 6 | 3 | Cable Harness Connector Kit | 817-7000 818-7001 |

Table 9-26 - Configurations and Specifications of IPX Devices

9.47.2 IPX 15 Relay

The IPX 15 board provides expansion I/O for the Supervisory Controller.

Configurations and Specifications of IPX Devices:

| Name | HW Format | Analog Inputs | Digital Inputs | Relays | Analog Outputs |
|--------------------|-------------|---------------|----------------|--------|----------------|
| IPX115D IPX215D | 10 DIN Rail | 10 | 20 | 15 | 6 |

Table 9-27 - Configurations and Specifications of IPX Devices

9.47.3 IPX 25 Relay

The IPX 25 board provides expansion I/O for the Supervisory Controller.

Configurations and Specifications of IPX Devices:

| Name | HW Format | Analog Inputs | Digital Inputs | Relays | Analog Outputs | Connector Types | Part Number |
|---------|-------------|---------------|----------------|--------|----------------|--------------------------------|-------------|
| IPX125D | 10 DIN Rail | 10 | 20 | 25 | 6 | Cable Harness Connector Kit | 817-7002 |
| IPX225D | | | | | | | 818-7003 |

Table 9-28 - Configurations and Specifications of IPX Devices

9.48 Supported Refrigerants

The firmware supports many refrigerant types. The tables include dew (vapor), mid-point, and end-point curves.

| Key | Description |
|---------------------|--|
| No glide | Single refrigerant or azeotropic blend |
| Mid-point (M) | Uses mid-point between bubble and dew |
| End-point Shift (E) | Uses end-point shift at 50 degrees F. Uses bubble above 50 and dewpoint at or below 50 |
| Bubble (B) | Bubble (Liquid) |
| Dew (D) | Dew (Vapor) |

Table 9-29 - Legend

| Refrigerant | No Glide | Mid-Point | Dew | Bubble | End-Point Shift |
|-------------|----------|-----------|-----|--------|-----------------|
| R502 | ✓ | | | | |
| R22 | ✓ | | | | |
| R401A | | ✓ | | | |
| R401B | | ✓ | | | |
| R402A | | ✓ | | | |
| R402B | | ✓ | | | |
| R408A | | ✓ | | | |
| R134A | ✓ | | | | |
| R404A | | ✓ | | | |
| R507 | ✓ | | | | |
| R438 | | ✓ | ✓ | ✓ | |
| R717 | ✓ | | | | |

Table 9-30 - Supported Refrigerants

| | | | | | |
|-------|---|---|---|---|---|
| R410A | | ✓ | | | |
| R422A | | | | | ✓ |
| R422D | | | | | ✓ |
| R407A | | ✓ | ✓ | ✓ | |
| R407C | | | | | ✓ |
| R407F | | | ✓ | ✓ | ✓ |
| R744 | ✓ | | | | |
| R448A | | ✓ | ✓ | ✓ | |
| R450A | | ✓ | | | |
| R449A | | ✓ | ✓ | ✓ | |
| R513A | | | | ✓ | |

Table 9-30 - Supported Refrigerants

Connect+ Update Required

| Supervisory Controller Version | Recommended Connect+ Version |
|--------------------------------|------------------------------|
| 2.28F02 | 1.5.9F01 |

Table 9-31 - Supervisory Controller and Connect+ Compatibility Matrix

It is recommended to upgrade to the latest Connect+ version. If you plan to upgrade Supervisory controllers and Connect+ at the same time, upgrade Connect+ to the latest version first, then update the Supervisory controllers. Contact Copeland for more information about upgrading.

10 Floor Plans

Floor Plans and Custom Screens (also called GS or Graphical Status screens) allow technicians or non-technician Supervisor users to monitor their HVAC/R systems in a Floor Plan view. Custom screens provide a Floor Plan with mapped temperature and pressure readings, refrigeration, defrost, fan status. And other system information. Note that Floor Plans are a licensed application and you will need to obtain the appropriate credentials before your controller can be set up with Floor Plans.

Contact Copeland Customer Service at ColdChain.CustomerService@copeland.com or Technical Support at ColdChain.TechnicalServices@Copeland.com for licensing information or call 770-425-2724.

Custom screens are created in Connect+ software programs. These programs are web-based Enterprise Software for communicating with store-based systems. Please contact your Sales representative or Technical Support for information on obtaining and working with these programs.

A Graphical Status Screen is a customized floor plan that displays refrigeration and environmental control values on a single page with real-time values for multiple entities within the store. The information can be displayed using a variety of presentation models (widgets) that are available in the Widget Editor (for example, animation, text, and many illustrated instruments to choose from). Historically, a graphical status screen has been associated with a specific application type in the Supervisor controller (such as a suction group, condenser, or circuit).

Log into Connect+ and locate the Views menu on the navigation tree. This menu is available from all levels in the navigation tree and from there you can select Add GS Screen and start creating your Floor Plan using the top menu.



Figure 9-1 - Views

Begin creating your Floor Plan by clicking the Add Widgets menu  and choosing from multiple icons.

Click the Image Library menu  and select from a large selection of System and User images for your Floor Plan.

An example for a Floor Plan can be as simple as this:

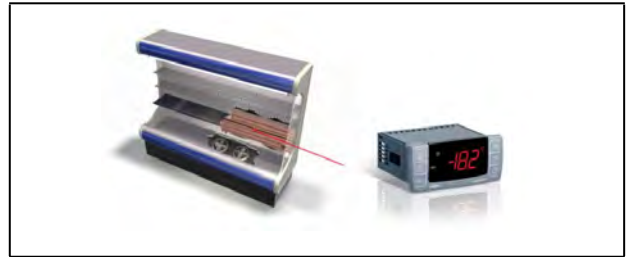



Figure 9-2 - Simple Floor Plan

Or more extensive:





Figure 9-3 - Extensive Floor Plan

Run and Edit modes are toggled at the top of the screen under the Run and Edit tabs.

If you wish to cancel or delete your Floor Plan and start over, click the delete icon .

When you are ready to save, fill out the Properties of your

Floor Plan by clicking the Properties  icon. From here you will name your Floor Plan and fill out other information. Once you are ready to export, click the

export zip icon  and it will be saved by default in your Downloads folder and depending on which browser you are using, it may show at the bottom of your browser window.

Importing a Floor Plan into the Supervisor

Once you have obtained the proper licensing to use Floor Plans, you can import a Floor Plan by following these steps:

Log into the Supervisor and click the Main Menu gear icon  to access Configure System > File Management & Licensing.

Or click the Floor Plan icon from the top  menu. If Floor Plans have been licensed, this icon will be visible at the top of your screen. Click Install at the top right to show more information and for installation.

Appendix A: Alarm Advisories

The table below is a list of all alarm messages that may appear in the Supervisory Controller Alarm Advisory Log. Each alarm message is listed by its Alarm Items, Alarm Category and Cell Name.

Note: The Supervisory Controller has the ability to disable advisories from XM and XR devices when desired. In the Device Application Details Page, Alarm Conf tab, Select "Disable" from the list to disable alarms that are not desired.

| Alarm Items | Category | Cell Name | Description |
|------------------------|--------------|------------------|---|
| Read Data Failed AI 01 | Device Alarm | IPX6/IPX15/IPX25 | Can be configured to different sensor types; they can be configured as "Input not used" or "Digital Input" . If configured to a specific type sensor, whereas there is no sensor connected to this port or there is something wrong with the connected sensor, and no valid data can be read from the analog input, the corresponding alarm will be generated. The alarm is not applicable if the analog input is configured to "Input not used" or "Digital Input" . |
| Read Data Failed AI 02 | Device Alarm | IPX6/IPX15/IPX25 | Can be configured to different sensor types; they can be configured as "Input not used" or "Digital Input" . If configured to a specific type sensor, whereas there is no sensor connected to this port or there is something wrong with the connected sensor, and no valid data can be read from the analog input, the corresponding alarm will be generated. The alarm is not applicable if the analog input is configured to "Input not used" or "Digital Input" . |
| Read Data Failed AI 03 | Device Alarm | IPX6/IPX15/IPX25 | Can be configured to different sensor types; they can be configured as "Input not used" or "Digital Input" . If configured to a specific type sensor, whereas there is no sensor connected to this port or there is something wrong with the connected sensor, and no valid data can be read from the analog input, the corresponding alarm will be generated. The alarm is not applicable if the analog input is configured to "Input not used" or "Digital Input" . |
| Read Data Failed AI 04 | Device Alarm | IPX6/IPX15/IPX25 | Can be configured to different sensor types; they can be configured as "Input not used" or "Digital Input" . If configured to a specific type sensor, whereas there is no sensor connected to this port or there is something wrong with the connected sensor, and no valid data can be read from the analog input, the corresponding alarm will be generated. The alarm is not applicable if the analog input is configured to "Input not used" or "Digital Input" . |
| Read Data Failed AI 05 | Device Alarm | IPX6/IPX15/IPX25 | Can be configured to different sensor types; they can be configured as "Input not used" or "Digital Input" . If configured to a specific type sensor, whereas there is no sensor connected to this port or there is something wrong with the connected sensor, and no valid data can be read from the analog input, the corresponding alarm will be generated. The alarm is not applicable if the analog input is configured to "Input not used" or "Digital Input" . |
| Read Data Failed AI 06 | Device Alarm | IPX6/IPX15/IPX25 | Can be configured to different sensor types; they can be configured as "Input not used" or "Digital Input" . If configured to a specific type sensor, whereas there is no sensor connected to this port or there is something wrong with the connected sensor, and no valid data can be read from the analog input, the corresponding alarm will be generated. The alarm is not applicable if the analog input is configured to "Input not used" or "Digital Input" . |

| Alarm Items | Category | Cell Name | Description |
|------------------------|--------------|------------------|---|
| Read Data Failed AI 07 | Device Alarm | IPX6/IPX15/IPX25 | Can be configured to different sensor types; they can be configured as "Input not used" or "Digital Input" . If configured to a specific type sensor, whereas there is no sensor connected to this port or there is something wrong with the connected sensor, and no valid data can be read from the analog input, the corresponding alarm will be generated. The alarm is not applicable if the analog input is configured to "Input not used" or "Digital Input" . |
| Read Data Failed AI 08 | Device Alarm | IPX15/IPX25 | Can be configured to different sensor types; they can be configured as "Input not used" or "Digital Input" . If configured to a specific type sensor, whereas there is no sensor connected to this port or there is something wrong with the connected sensor, and no valid data can be read from the analog input, the corresponding alarm will be generated. The alarm is not applicable if the analog input is configured to "Input not used" or "Digital Input" . |
| Read Data Failed AI 09 | Device Alarm | IPX15/IPX25 | Can be configured to different sensor types; they can be configured as "Input not used" or "Digital Input" . If configured to a specific type sensor, whereas there is no sensor connected to this port or there is something wrong with the connected sensor, and no valid data can be read from the analog input, the corresponding alarm will be generated. The alarm is not applicable if the analog input is configured to "Input not used" or "Digital Input" . |
| Read Data Failed AI 10 | Device Alarm | IPX15/IPX25 | Can be configured to different sensor types; they can be configured as "Input not used" or "Digital Input" . If configured to a specific type sensor, whereas there is no sensor connected to this port or there is something wrong with the connected sensor, and no valid data can be read from the analog input, the corresponding alarm will be generated. The alarm is not applicable if the analog input is configured to "Input not used" or "Digital Input" . |
| Read Data Failed AI 01 | System Alarm | OnBoard | Should be generated if sensors are configured but disconnected. If the advisory is reset, and the alarm/notice condition still exists, the delay period will be used. Advisories will return to normal if the command value stays in the non-alarm/notice condition. |
| Read Data Failed AI 02 | System Alarm | OnBoard | Should be generated if sensors are configured but disconnected. If the advisory is reset, and the alarm/notice condition still exists, the delay period will be used. Advisories will return to normal if the command value stays in the non-alarm/notice condition. |
| Read Data Failed AI 03 | System Alarm | OnBoard | Should be generated if sensors are configured but disconnected. If the advisory is reset, and the alarm/notice condition still exists, the delay period will be used. Advisories will return to normal if the command value stays in the non-alarm/notice condition. |
| Read Data Failed AI 04 | System Alarm | OnBoard | Should be generated if sensors are configured but disconnected. If the advisory is reset, and the alarm/notice condition still exists, the delay period will be used. Advisories will return to normal if the command value stays in the non-alarm/notice condition. |
| Read Data Failed AI 05 | System Alarm | OnBoard | Should be generated if sensors are configured but disconnected. If the advisory is reset, and the alarm/notice condition still exists, the delay period will be used. Advisories will return to normal if the command value stays in the non-alarm/notice condition. |

| Alarm Items | Category | Cell Name | Description |
|------------------------------|-------------------|----------------------|---|
| Read Data Failed AI 06 | System Alarm | OnBoard | Should be generated if sensors are configured but disconnected. If the advisory is reset, and the alarm/notice condition still exists, the delay period will be used. Advisories will return to normal if the command value stays in the non-alarm/notice condition. |
| Read Data Failed AI 07 | System Alarm | OnBoard | Should be generated if sensors are configured but disconnected. If the advisory is reset, and the alarm/notice condition still exists, the delay period will be used. Advisories will return to normal if the command value stays in the non-alarm/notice condition. |
| Read Data Failed AI 08 | System Alarm | OnBoard | Should be generated if sensors are configured but disconnected. If the advisory is reset, and the alarm/notice condition still exists, the delay period will be used. Advisories will return to normal if the command value stays in the non-alarm/notice condition. |
| Network Device Offline | System Alarm | None | The current controller could not find the specified device controller. Device applications will generate an Offline advisory if the device fails to communicate after it is commissioned. When the advisory is generated, the status of the application will be offline. |
| Control Temp High Alarm | Application Alarm | AHU | A control temperature advisory should occur after a user specified time delay for both high and low temperature conditions. This advisory should have associated parameters to allow the user to specify the high and low advisory value and the delay. This advisory should have separate setpoints for occupied and unoccupied mode. |
| Control Temp Low Alarm | Application Alarm | AHU | A control temperature advisory should occur after a user specified time delay for both high and low temperature conditions. This advisory should have associated parameters to allow the user to specify the high and low advisory value and the delay. This advisory should have separate setpoints for occupied and unoccupied mode. |
| Fan Proof Fail | Application Alarm | AHU | When enabled (Fan Prf Fail En) and a fan proof failure is detected, heating and cooling loads will be shut down until the proof failure goes away or the fan proof alarm is reset or cleared. If the fan is configured to shut down on a fan proof failure, the system may be restarted by setting the FAN FAIL RST input to ON or clearing the fan proof failure from the advisory log. |
| Control Value Limit Exceeded | Application Alarm | AnalogSensorControl | There is a high and low limit alarm for the inputs after they are combined and filtered. The user sets occupied and unoccupied, high and low setpoints. If the combined/filtered value exceeds the alarm setpoints an alarm is generated based on the Alarm Type setting. |
| Demand Limit Exceeded | Application Alarm | DemandControl | The application will provide an application alarm to signal a high demand. The demand alarm limit and alarm delay should be configurable. |
| Command Value Trip | Application Alarm | DigitalSensorControl | The command value will be used to determine the alarm state. The command value is the combined value of all the digital inputs of the cell, plus occupancy, and schedules. When the command value changes to an alarm condition, the delay timer will start. If the state changes, the timer will stop and no alarm will be issued. If the state stays for the duration of the timer, an advisory will be issued. If a state change occurs to the opposite state after the advisory has been issued, it will be returned to normal. |

| Alarm Items | Category | Cell Name | Description |
|-------------------------|-------------------|----------------------|---|
| Proof Failure | Application Alarm | DigitalSensorControl | A proof checking device is registering a failure in one of the Application's control devices. |
| Proof Fail | Application Alarm | Lighting | Proof delay. When the Lighting Control application detects a proof failure, it will wait for the Proof Delay time period to pass before turning on the Proof Status output. If during this delay the proof input returns to normal, the delay is canceled and the Proof Status output remains OK. |
| LLev Proof Fail | Application Alarm | Lighting | Light level proofing alarm delay. The Light Level Proof Delay is the amount of time after sunrise or sunset that, if the light level sensor does not cut ON or OFF appropriate to the light level of a sunrise or sunset, will generate an alarm. In other words, if the Light Level Proof Delay is set for 1 hour, the light level must fall below the cut-off setpoint at least one hour after sundown, or else an alarm will be generated. Likewise, if the cut-on light level setpoint is not reached by at least one hour after sunrise, an alarm will be generated. |
| Curtail On | System Alarm | GlobalData | A Curtailment device set up in Global Data has activated to begin curtail. |
| All Lights On | System Alarm | GlobalData | All Lights On input in Global Data application has turned ON to switch on all the lights. |
| HVAC Shutdown | System Alarm | GlobalData | A Global Data application's HVAC Shutdown input has turned ON to shut down all HVAC systems. |
| REFR Shutdown | System Alarm | GlobalData | A Global Data application's REFR Shutdown input has turned ON to shut down all suction groups, condensers, and circuits. |
| HVAC Phase Loss | System Alarm | GlobalData | A phase loss device connected to Global Data has switched ON to shut down all HVAC systems. |
| REFR Phase Loss | System Alarm | GlobalData | A phase loss device connected to Global Data has switched ON to shut down all refrigeration systems. |
| Archive Percentage Full | System Alarm | LogGroup | The controller supports the ability to archive log data to the SD card if installed. The controller allows the end user to specify on a per log group basis the destination of the archive. If configured and the SD card is subsequently removed or if the SD card becomes Archive Notice percentage full, a NOTICE advisory is generated and log data archiving is suspended (Log Archive disabled). |
| Demand Limit Exceeded | Application Alarm | UtilityMonitoring | The application will provide an application alarm to signal a high demand. The demand alarm limit and alarm delay should be configurable. The demand alarm limit is the amount of time the application will wait after the Shed output turns on, before the demand alarm is generated. Also, the Shed Output may be configured to be controlled by either the average or instantaneous usage rate. |
| Heating Problem | Device Alarm | T-Stat | Heating Two Hours - Thermostat did not see a rise in supply temperature when heating was called for. |
| Heat Shutdown | Device Alarm | T-Stat | Heat Continuous - In heat or backup heat mode, thermostat shall open latching relay contacts if temperature is over 10°F above setpoint. |
| Failed Sensor | Device Alarm | T-Stat | Temperature Sensor Fail - Thermostat has detected a failure of the internal space temperature sensor. |

| Alarm Items | Category | Cell Name | Description |
|----------------------------|--------------|-----------|--|
| Stuck Key | Device Alarm | T-Stat | A stuck key (closed) has been detected on the thermostat. |
| Unexpected Temp Change | Device Alarm | T-Stat | If heating or cooling is engaged, and either the indoor temperature sensor reading, or the supply air temperature sensor reading starts moving the opposite way at a higher rate than it was before the heating or cooling was engaged, the thermostat shall report a diagnostic message, and shut down the operation. |
| Cooling Problem | Device Alarm | T-Stat | Cool Eight Hours - If cool runs for over 8 hours continuously, the thermostat shall set anticipator to zero until call for cool is satisfied. |
| Proof Fail | Device Alarm | T-Stat | Fan Not Detected - Any time, when the fan is activated and if the Fan Detect input is enabled, the Thermostat shall check its status 15 seconds after the fan is energized, and if the fan is not on, it shall disable any active heat or cool calls, and report an alarm. |
| Frost Protection Activated | Device Alarm | T-Stat | The thermostat shall allow a frost protection menu option. When enabled, frost protection is enabled in all system modes including OFF, when temperature drops below 42°F (5.6°C). All other heat / cool calls are disabled, and indoor heat is activated until the temperature rises above the frost protection threshold. |
| Long Run Time | Device Alarm | T-Stat | Compressor is running extremely long run cycles (typically for over 18 hours). The possible causes are: Low refrigerant charge, Evaporator blower is not running, Evaporator coil is frozen, Faulty metering device, Condenser coil is dirty, Thermostat is malfunctioning, Compressor Second Stage Cooling Wiring. |
| System Pressure Trip | Device Alarm | T-Stat | Discharge or pressure out of limits or compressor overloaded. The possible causes are: High head pressure, Condenser coil poor air circulation (dirty, blocked, damaged), Condenser fan is not running, Return air duct has substantial leakage. |
| Short Cycling | Device Alarm | T-Stat | Compressor is running only briefly. The possible causes are: Thermostat demand signal is intermittent, Time delay relay or control board is defective, High pressure switch present. |
| Locked Rotor | Device Alarm | T-Stat | Locked rotor. The possible causes are: Run capacitor has failed, Low line voltage, Excessive liquid refrigerant in compressor, Compressor bearings are seized. |
| Open Circuit | Device Alarm | T-Stat | Compressor open circuit. The possible causes are: Outdoor unit power disconnect is open, Compressor circuit breaker or fuse(s) is open, Compressor contactor has failed open, High pressure switch is open and requires manual reset, Open circuit in compressor supply wiring or connections, Unusually long compressor protector reset time due to extreme ambient temperature, Compressor windings are damaged. |
| Open Start Circuit | Device Alarm | T-Stat | Compressor current only in run circuit. The possible causes are: Run capacitor has failed, Open circuit in compressor start wiring or connections, Compressor start winding is damaged. |
| Open Run Circuit | Device Alarm | T-Stat | Compressor current only in start circuit. The possible causes are: Open circuit in compressor run wiring or connections, Compressor run winding is damaged. |
| Welded Contactor | Device Alarm | T-Stat | Compressor always runs. The possible causes are: Compressor contactor has failed closed, Thermostat demand signal is not connected to module. |

| Alarm Items | Category | Cell Name | Description |
|-----------------|--------------|-----------|--|
| Low Voltage | Device Alarm | T-Stat | Control circuit < 17VAC. The possible causes are: Control circuit transformer is overloaded, Low line voltage (contact utility if voltage at disconnect is low). |
| Protector Trip | Device Alarm | T-Stat | Thermostat demand signal Y is present, but the compressor is not running. The possible causes are: Compressor protector is open, Outdoor unit power disconnect is open, Compressor circuit breaker or fuse(s) is open, Broken wire or connector is not making contact, High pressure switch open if present in system, Compressor contactor has failed open. |
| Case Temp Fail | Device Alarm | XR75CX | (Case temperature probe failure alarm) Alarm when the case termination probe fails. |
| Defr Term Fail | Device Alarm | XR75CX | (Defrost termination probe failure alarm) Alarm when the defrost termination probe fails. |
| High Case Alarm | Device Alarm | XR75CX | Alarm if case temperature exceeds maximum case temperature setpoint. |
| Low Case Alarm | Device Alarm | XR75CX | Alarm if case temperature falls below minimum case temperature setpoint. |
| RTC Data Lost | Device Alarm | XR75CX | Alarm when the real time clock data is lost. |
| RTC Failure | Device Alarm | XR75CX | Alarm when the real time clock fails. |
| External Alarm | Device Alarm | XR75CX | Alarm that indicates whether the relay is configured for alarming. |
| Door Open | Device Alarm | XR75CX | The door open alarm is activated. |
| EEPROM Failure | Device Alarm | XR75CX | Alarm when the flash memory in the device fails. |

Appendix B: Troubleshooting

The chart below describes symptoms and solutions if troubleshooting the system or equipment is needed. *For further information, contact Technical Support 833-409-7505 or email ColdChain.TechnicalServices@copeland.com*

| SYMPTOM | POSSIBLE PROBLEM | SOLUTION |
|--|--|---|
| Getting Started | First Steps - Where Do I Start? | Call Technical Support 833-409-7505 or refer to the Supervisor Quick Start Guide (P/N 026-4144) . |
| Unable to Connect to Supervisory Controller | IP Address Unknown | Connect to Supervisory Controller - get IP Address. For instructions for how to set a fixed IP Address, refer to the Supervisor Quick Start Guide (P/N 026-4144) . |
| Browser Connection Problems | Browser is Unsupported | Supported Browsers: Google Chrome 105.0.5195 and later, Firefox 105.0 and later, MAC Safari 14.1.2 and later, iOS Safari 14.7 and later, Microsoft Edge 84.0.522 and later, and Android Chrome/WebView 105.0.5195 and later |
| Unable to Determine IP Address or Unknown IP Address (See page B-6 for more information) | Trouble Connecting | Check IPme text file procedure: <ol style="list-style-type: none"> 1. Place file on USB drive. Save the .txt to the root of the USB drive. 2. Insert USB drive into the USB port. After 3-5 minutes, the Ipme.txt will display. 3. Check the extension Ipme.txt. 4. Remove USB drive. 5. Insert the USB drive into your PC. 6. View the profile. |
| Unable to Log into Supervisory Controller | Incorrect password is being used. | Supervisory Controller is password protected. Contact your Supervisory Controller Administrator to request a password. |
| Unable to Access Supervisory Controller Remotely | Connection method is set up incorrectly. | <ul style="list-style-type: none"> • Check network connections. • Check Ethernet connection. • Check cellular modem connection. |

| SYMPTOM | POSSIBLE PROBLEM | SOLUTION |
|-------------------------------|--|---|
| Device Communication Problems | XR75CX | Refer to the XR75CX manual (P/N 026-1210) for more information. |
| | IPX-Expansion Modules | Refer to the iPro DAC manual (P/N 026-1727) for more information. |
| | T-stat Touchscreen Thermostat | Refer to the T-Stat manual (P/N 026-1729) for more information. Refer to the Touchscreen Thermostat manual (P/N 026-1739) for more information. |
| | Energy Meter | Refer to the Energy Meter manual (P/N 026-1726) for more information. |
| | ACC | Refer to the ACC manual (P/N 026-4704) for more information. |
| | MRLDS | Refer to the MRLDS manual (P/N 026-1307) for more information. |
| | MRLDS-250 | Refer to the MRLDS-250 manual (P/N 026-1315) for more information. |
| | MRLDS-450 | Refer to the MRLDS-450 manual (P/N 026-1316) for more information. |
| | Mechanical Overrides | Check continuity tester - verify if the override is showing a closure. |
| X Line Condensing Unit | Refer to X Line AE5-1412 User Manual | |
| I/O Network Problems | I/O board not getting power. | Check I/O board power if the green STATUS light is ON. If not, check power wiring connections, and use a multimeter to verify the board is getting 24VAC. Reset power to board. |
| | I/O board not communicating or will not come online. | Check I/O network connections: 1. Check wire polarity (positive to positive/negative to negative). 2. Check for broken or loose wires. |
| | Dip switches are set incorrectly. | Check I/O board network dip switches. Verify network ID number is not a duplicate and that baud rate switches are set to 9600. (If switches are wrong, make changes and then reset the controller). |
| | Terminating resistance jumpers are set incorrectly. | Check for proper setting of terminating resistance jumpers. Network segment should be terminated on the two endpoints of the daisy chain and unterminated everywhere else. |
| | Boards are not powered. | Check Network/Power voltages. |

| SYMPTOM | POSSIBLE PROBLEM | SOLUTION |
|--|--|--|
| Problems with Temp Sensor or Pressure Transducer Displaying Proper Value | 16AI input dip switches are set incorrectly. | The 16 dip switches on the 16AI board correspond to each of the inputs: Dip Switches Up = Temperature Sensor Dip Switches Down = Pressure Transducer |
| | Incorrect board and point address. | Set proper board and point settings for both input and output: Go to the Inputs tab in the application's Setup screen and check Board and Point. |
| | Incorrect sensor type. | <p>Verify that the sensor type in Site Supervisor is the same as the sensor installed. (For example, "5V-200PSI" is a 5-volt powered 200PSI pressure transducer, and "Temperature" is the standard Copeland temperature sensor.</p> <p><u>NOTE: The previous Eclipse and Standard sensors are now 5V and 12V respectively.</u></p> <p>For 16AI boards: For Onboard I/O:</p> <ol style="list-style-type: none"> 1. Log into the Supervisory Controller. 2. Click the Site Map icon. 3. Under Control Status, select System. 4. Click Onboard IO along the bottom of the screen. 5. Click Details. 6. Under Onboard IO DETAILS, click Setup. 7. Check the desired sensor type value from the list and click Edit to make changes. |
| No Heat Will Come On | Incorrect board and points assignment. Check the Heat OAT lockout temps. | <p>Make sure that your board and points are assigned to the correct compressors and heat stages.</p> <ol style="list-style-type: none"> 1. Log into the Supervisory Controller. 2. Click the Site Map icon. 3. Under Control Status, click HVAC. 4. Click Details. 5. If Heat Lockout En is enabled (set to ON), check that Heat OAT LOCK is set to a valid setpoint (temperature) for heat lock out. |
| No Cooling Will Come On | Incorrect board and points assignment. Check the Cool OAT lockout temps. | <p>Make sure that your board and points are assigned to the correct compressors and heat stages.</p> <ol style="list-style-type: none"> 1. Log into the Supervisory Controller. 2. Click the Site Map icon. 3. Under Control Status, click HVAC. 4. Click Details. 5. If Cool Lockout En is enabled (set to ON), check that Cool OAT LOCK is set to a valid setpoint (temperature) for cool lock out. |

| SYMPTOM | POSSIBLE PROBLEM | SOLUTION |
|--|--|---|
| Lighting Control Problems | Lights will not come on. | Make sure you have a Time Schedule set up. A Time Schedule is not Lighting Control. You can use the same Time Schedule for several Lighting Controls. Set up the Time Schedule first and then assign it to a Lighting Control. |
| | | Set up a Time Schedule and go to Lighting Control. 1. Log into the Supervisory Controller. 2. Click the Site Map icon. 3. Under Control Status , click Lighting . 4. Click Details . 5. Click Inputs (found in the right-side of the screen). 6. Click Edit . Select and expand SCHEDULE IN . 7. Select and expand TARGET and select the desired schedule from the drop-down list. 8. Select and expand PROPERTY and set to OUTPUT . This will feed the schedule into Lighting. |
| | | Make sure Lighting Control output is assigned. |
| Lights Will Not Come On With The Photocell | Photocell is not recognized by the controller. | Make sure the photocell is configured as an analog input. Verify that the type of light sensor is correct. If using a light level sensor from another Supervisory Controller, set it up on the controller it is associated with in the Global Data section. |

How to Locate the IP Address of the Supervisory Controller

1. On a blank USB drive, create a new **Text Document**.

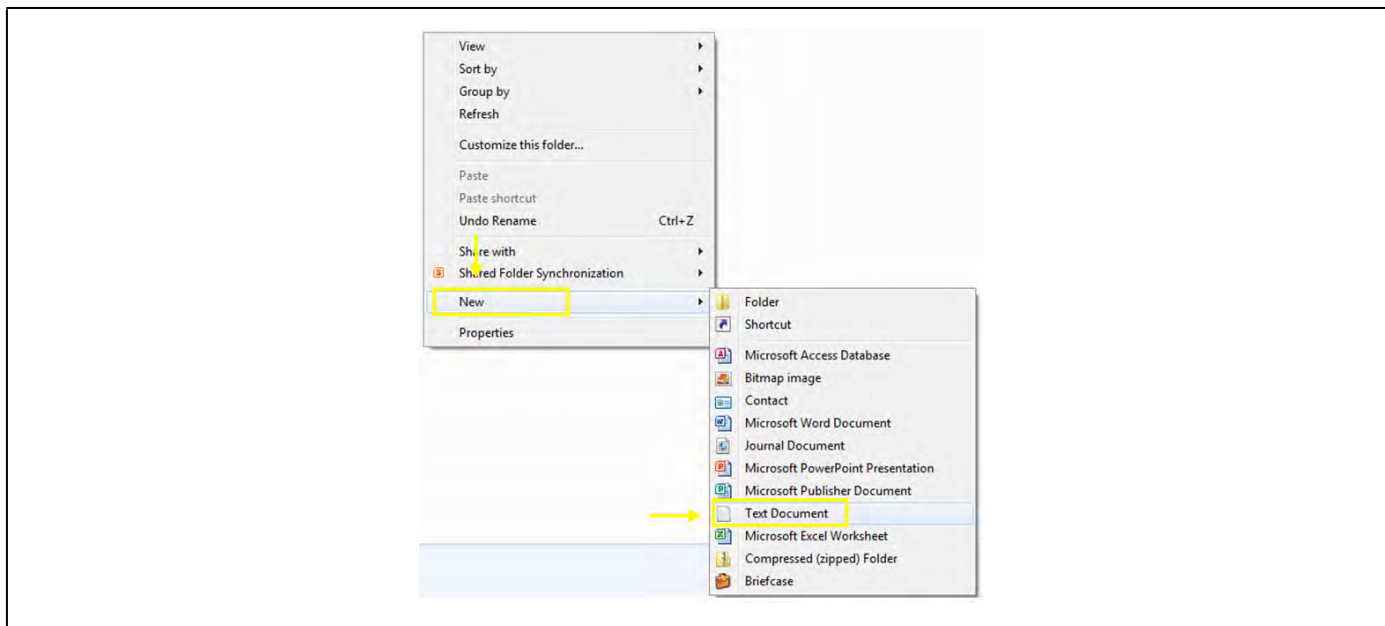

Creating a Blank Text Document

2. Name the text document **ipme.txt**.

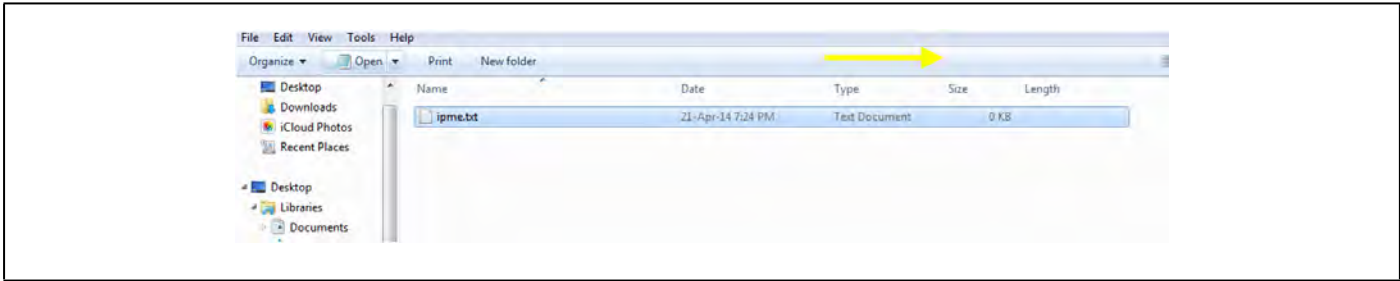

Saving the Document as ipme.txt

3. Remove the USB drive from the PC, do not power down the Supervisory Controller, then insert the USB drive.
4. Power up the supervisory controller; its green status will flash during the power-on cycle. Once the light stops blinking and turns solid, remove the USB Drive.
5. Insert the USB drive into the PC, then open the USB drive.
6. Do not power down the supervisor when trying to obtain the IP address with IPME text.

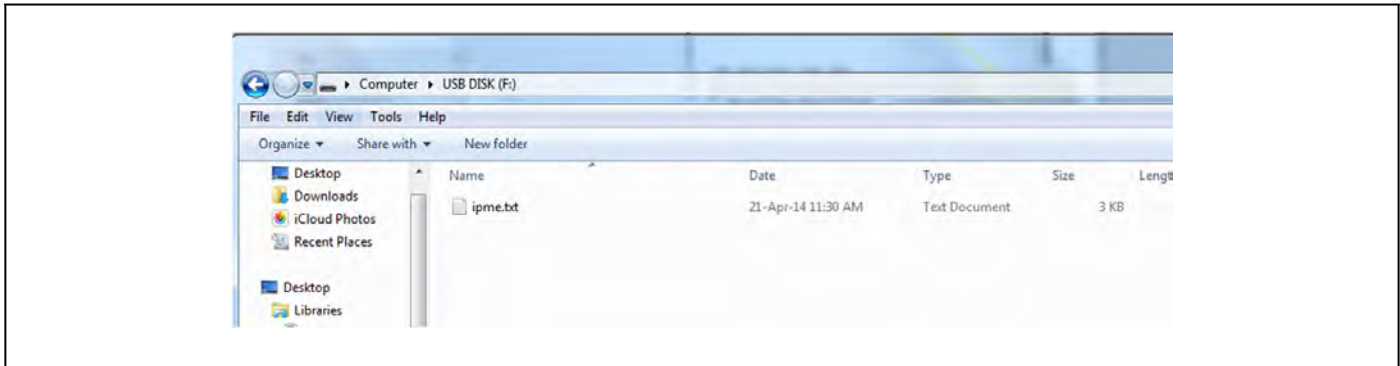

Opening the USB drive

7. Open the text document and the IP address of the Supervisory Controller that is displayed.

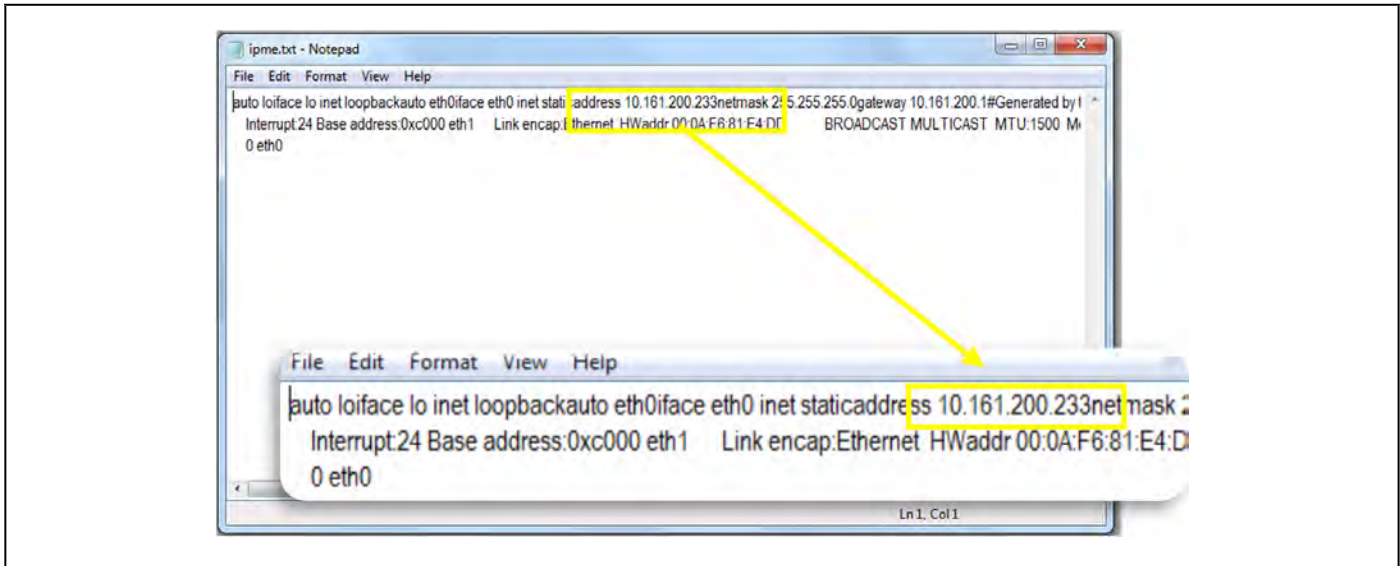

Supervisory Controller IP Address Display

How to Change the IP Address

Method 1: Direct Connect

1. Select the **Main Menu** icon  > **Configure System** > **General System Properties** > **Network Settings**:

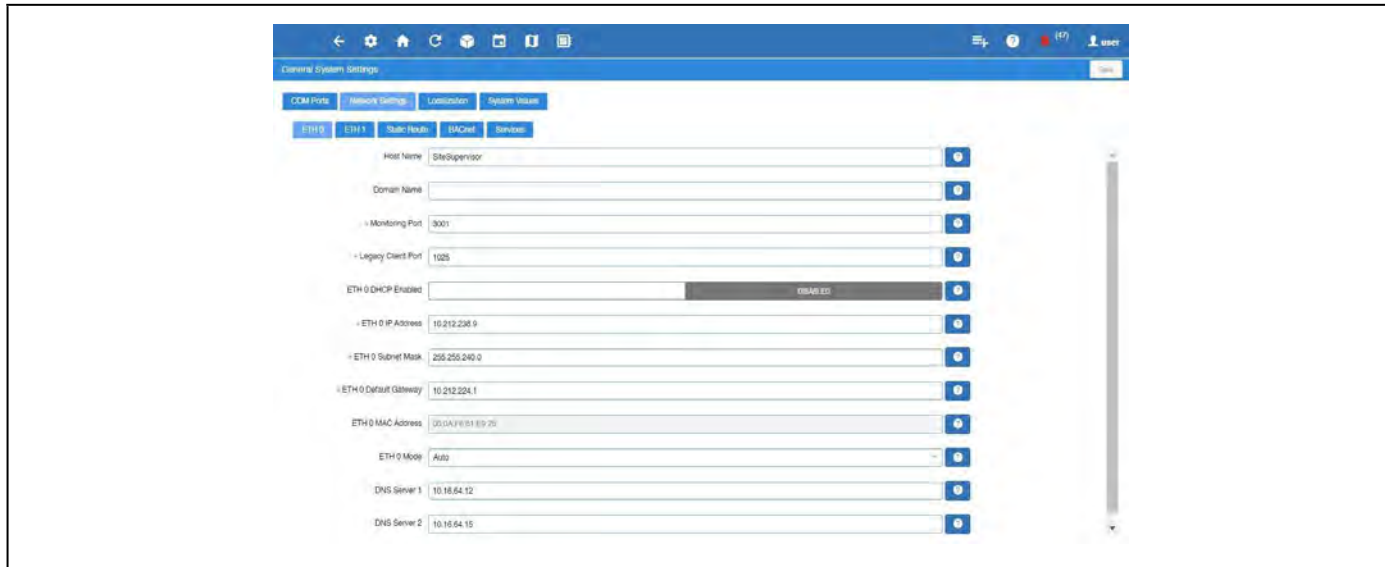

Enter IP Address in the ETH 0 IP Address Field

2. On the **INTERNET (TCP/IP)** section on the screen, enter the IP Address in the **ETH 0 IP Address** field.

Method 2: USB Port

1. Create a "network.txt" with your desired settings as shown below (*Network.txt Notepad*):

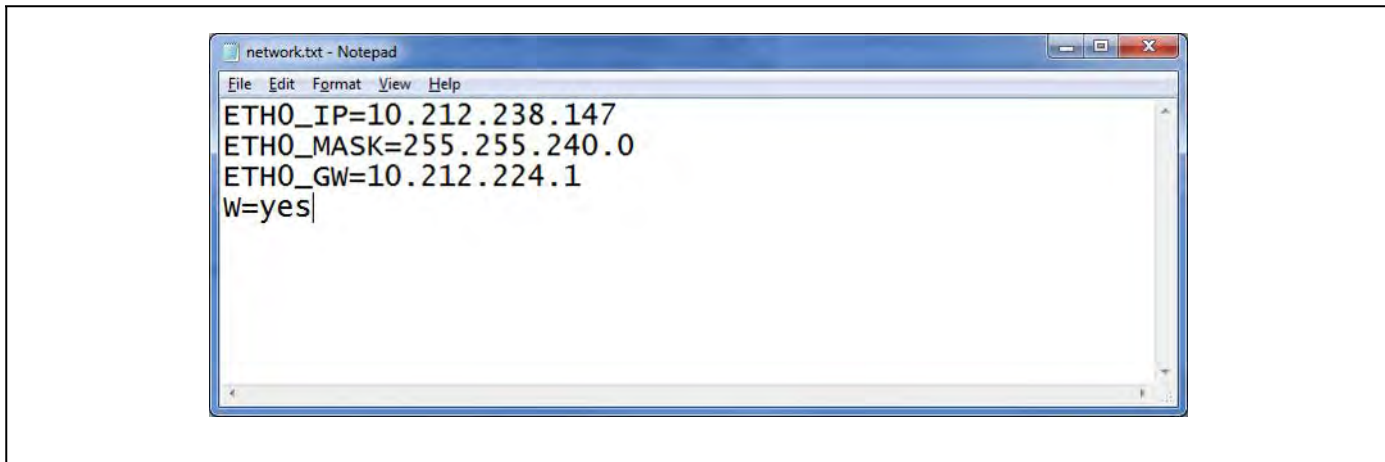

Network.txt Notepad

2. Save to the root folder of a thumb drive. Insert the thumb drive into the USB port of the Supervisory Controller.
3. Power cycle the Supervisory Controller. The new IP Address will be saved.

Updating the ETH1 IP Address on E3 Controllers

Changing the ETH1 IP address on E3 controllers is not recommended and will cause a communication loss between the control board and PIB of the E3, and all other devices and COM ports.

The E3 control board and the E3 PIB are networked devices. The PIB opens a TCP/IP connection to the control board. If the ETH1 address changes and the PIB is not updated to make it known, communication will be interrupted.

As with any local network, if the IP Address of device A is changed, the IP Address may become incompatible with device B, and the two will cease to communicate.

If the IP Address on ETH1 must be changed, starting with version 2.18, the following warning message will appear:

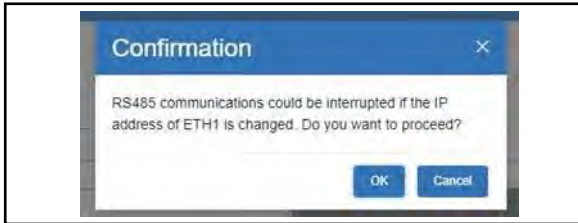

ETH1 IP Address Change Warning Message



Steps for Updating the ETH1 IP Address and Resuming Communication

STEP 1: Once the confirmation window appears, click **OK** to proceed or **Cancel** to stop.

STEP 2: Using a USB thumb drive, create a file in the root directory called **network.txt** and enter the following:

```
[Control]
eth0IP=<address of ETH1 on the E3>
eth0Mask=255.255.255.0
eth0Port=32000
```

If the IP address schema is drastically changing or if placing multiple E3s on the same private ETH1 network, then include the following to configure the PIB network settings.

Note: Peer communications are only available over ETH0.

Only include this section in the file if changing PIB IP device configuration:

```
[Display]
eth0IP=<address to configure PIB>
eth0Mask=255.255.255.x
eth0GW=<default gateway>
```

Instructions for network.txt file contents:

| If Using a Thumb Drive | Definition |
|---|---|
| [Control] | Section separator - must be included as is |
| eth0IP=<address of ETH1 on the E3> | Change this to match the E3 ETH1 address' new configuration |
| eth0Mask=255.255.255.0 | Should only be changed to match IP schema |
| eth0Port=32000 | DO NOT CHANGE THIS - but it must be included in file |
| If Changing the PIB IP Device Configuration | Definition |
| [Display] | Section separator - must be included as is |
| eth0IP=<address to configure PIB> | Change this to match the E3 ETH1 address' new configuration |
| eth0Mask=255.255.255.x | Should only be changed to match IP schema |
| eth0GW=<default gateway> | Should only be changed to match IP schema |

STEP 3: Save to the root folder of the USB thumb drive from your PC.

STEP 4: Plug the USB thumb drive into the USB port on the E3 and reboot the PIB for it to read.



USB Port on the E3 PIB

Appendix C: Setting Up Email and Text Alerts in Your Supervisory Controller

How to Send Emails and SMS Alarm Messages

Logging In

1. Launch a preferred web browser.



Log Into the Supervisory Controller

2. Enter the IP Address of the device.
3. The default IP Address is **192.168.0.250** for **ETH0** and **192.168.1.250** for **ETH1**.
4. Log into the Supervisory Controller by selecting **Login** located at the upper right side of the screen and enter your username and password.

How to Go to Network Settings

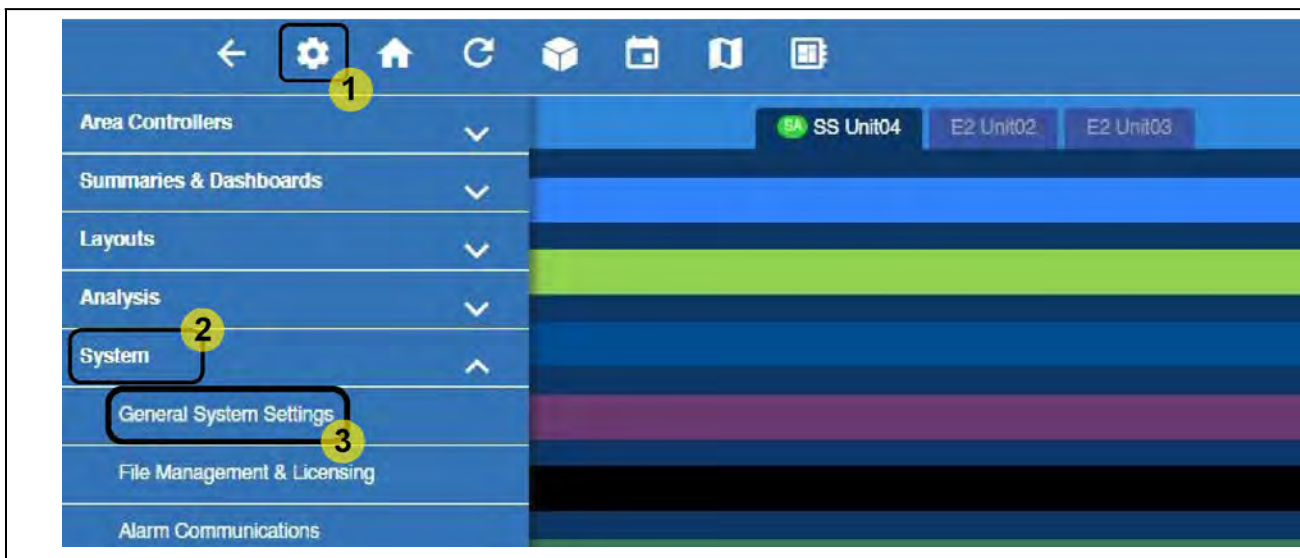

Access General System Properties

1. Click the **Setup** (gear)  icon.
2. Click **System**.

3. Click **General System Settings**.
4. Click **Network Settings** on the General System Settings page. Click **Advanced** to see all settings.

If Using Gmail, You Must Set Up a DNS Server:

For DNS Server 1 and 2 - A valid DNS server must be supplied to resolve "smtp.gmail.com."

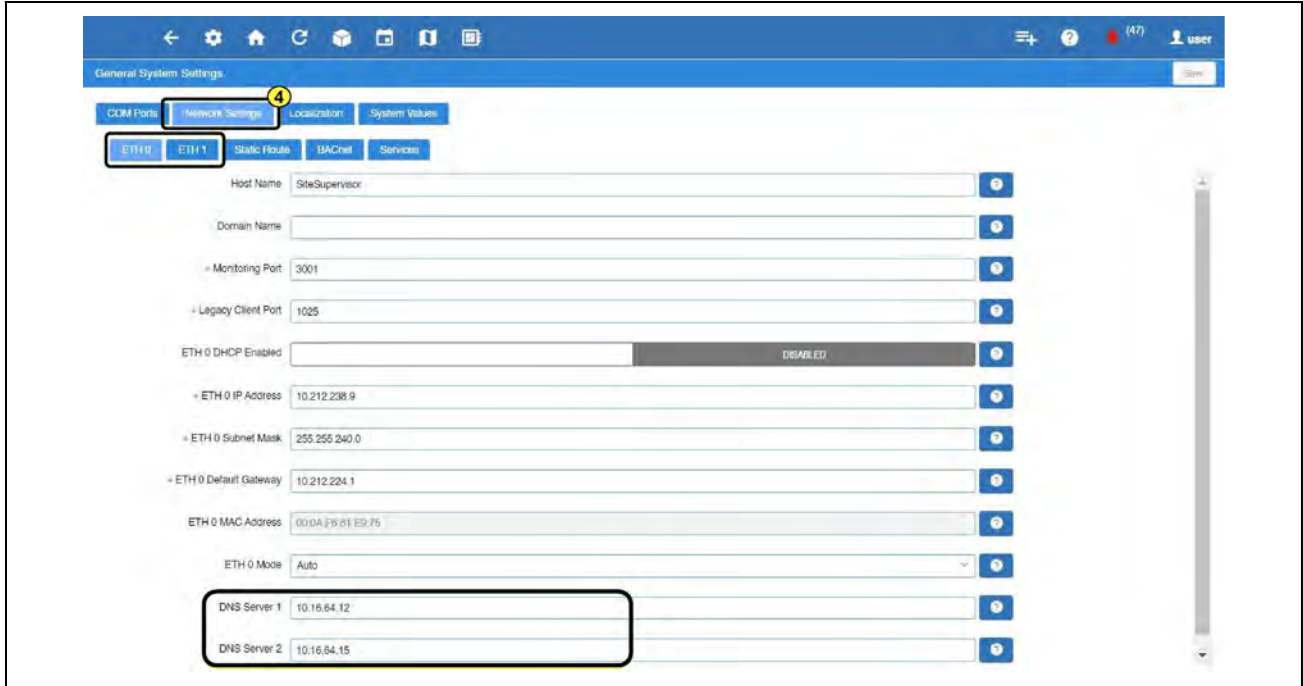

Network Settings for Internet (TCP/IP)

Messaging Setup

Email Messaging Setup

1. Scroll down to the bottom of the page to locate the options for email and text messaging:

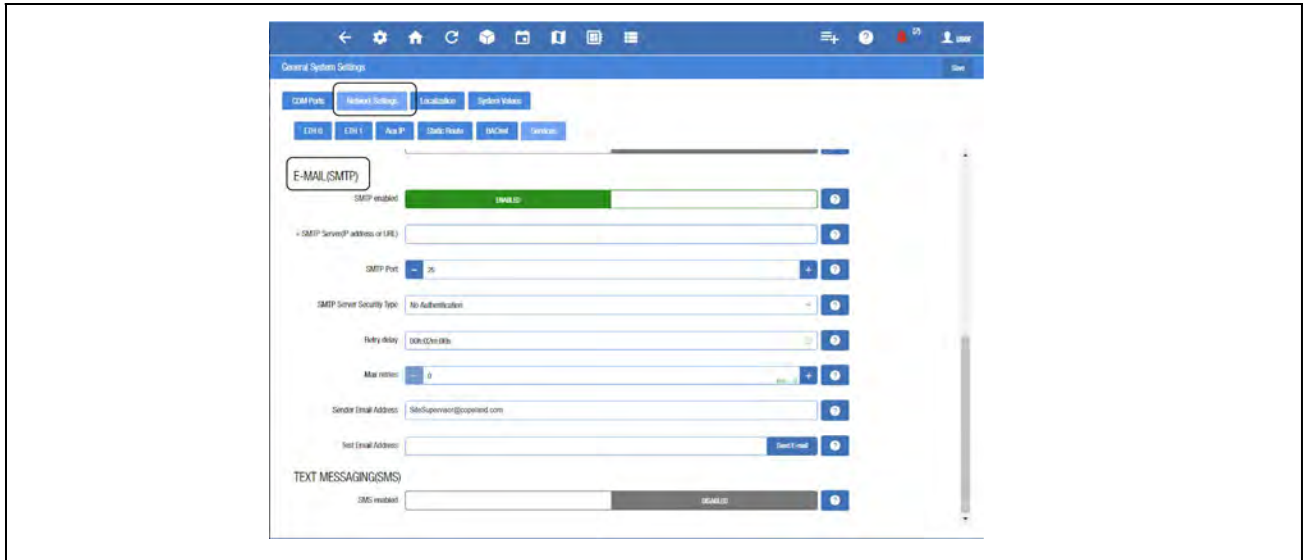

Email Messaging

2. Click the gray box to toggle **ENABLED** for SMTP email messaging. The setup options will appear after enabling.

SMTP Server

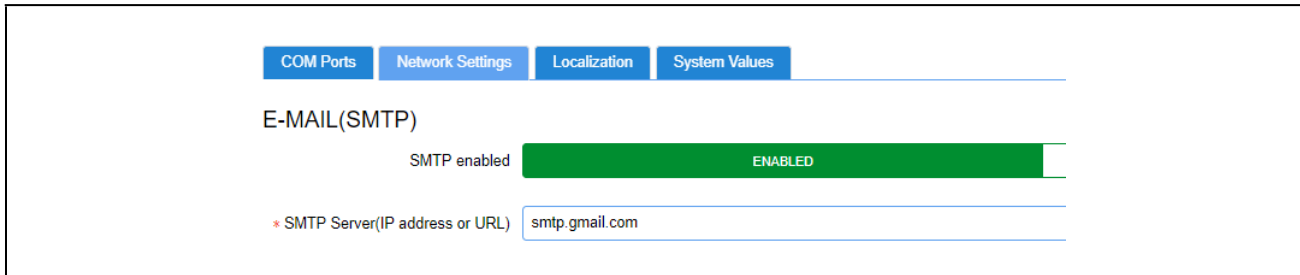

SMTP Server

- SMTP Server (Simple Mail Transfer Protocol) is an Internet standard for electronic mail transmission.
- SMTP Server can either be the server name or IP Address.
- Check with your local IT for the availability of SMTP on your local server.
- Example of an SMTP server that is available for public use is smtp.gmail.com.
- When SMTP has been enabled, the Test Email Address option becomes available. Enter the sender's email address and click Send E-mail to test and verify that notifications will be received by the correct email.

Default Gmail SMTP Settings

- Gmail SMTP server address: smtp.gmail.com
- Gmail SMTP username: Your full Gmail address (for example, yourusername@gmail.com)
- Gmail SMTP password: Use the app password created.
- Gmail SMTP port (TLS): 587 (for port 587, the Authentication type must be Username/Password TLS)
- Gmail SMTP port (SSL): 465
- Gmail SMTP TLS/SSL required: yes

IMPORTANT: For Gmail, access from inside the Gmail account must be enabled for less secure applications to receive emails.

E3/Site Supervisor Gmail SMTP Setup

The Sender Email Gmail Account will need to enable two-factor authentication and setup an APP PASSWORD for the E3/SS to use.

1. Navigate to **myaccount.google.com/security** and login with the SENDER EMAIL username and password.
2. Search **App passwords** in the **Search Google Account** search field.

3. Select **App passwords** from the results.

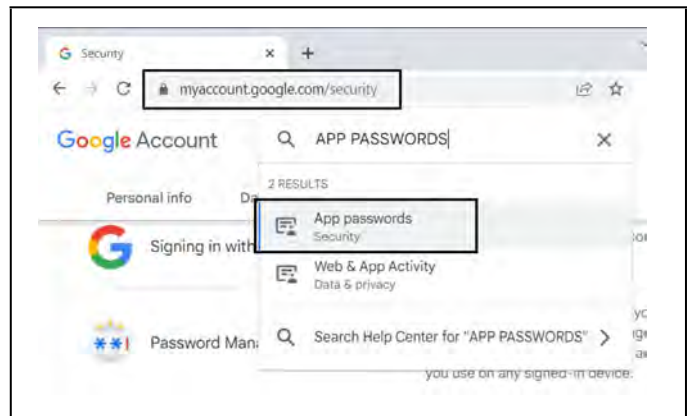

Account Security

- In the App Passwords page, click **Select App** and select **Other (Custom Name)** from the drop-down menu.

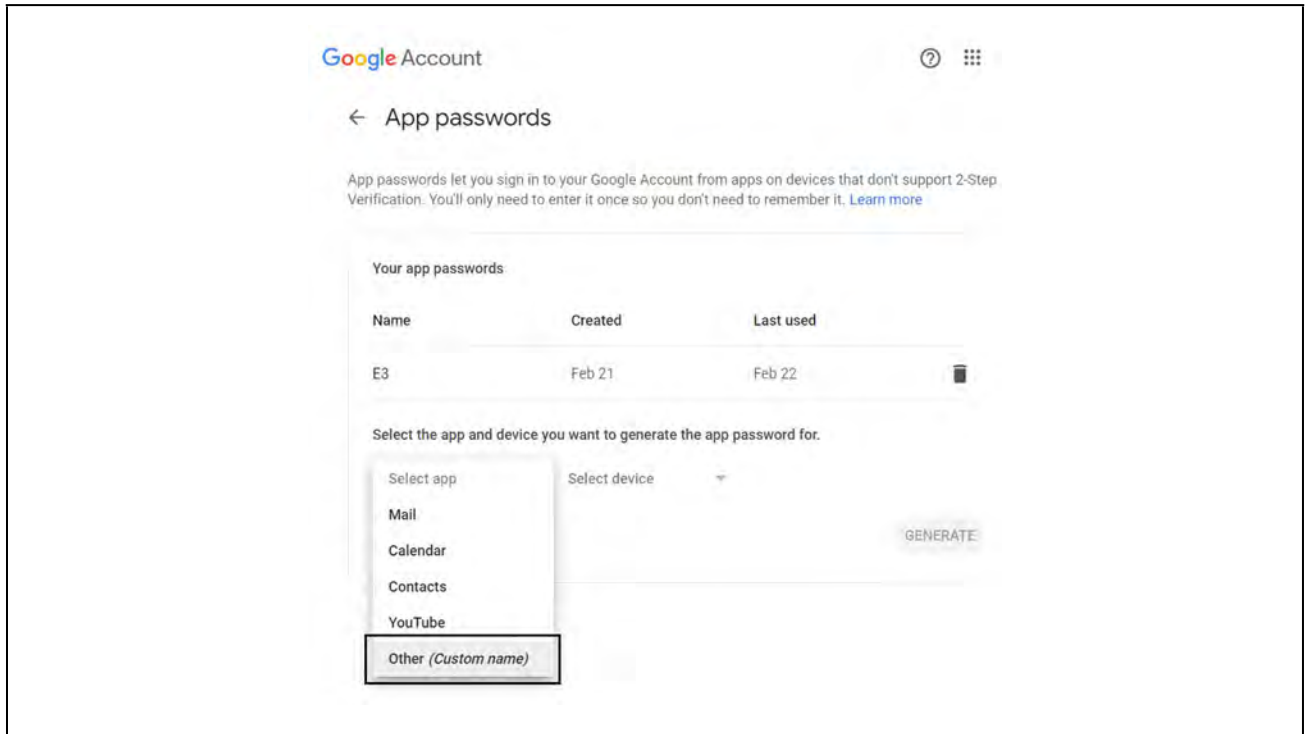

App Passwords

- Name the E3/Site Supervisor and click the **Generate** button.

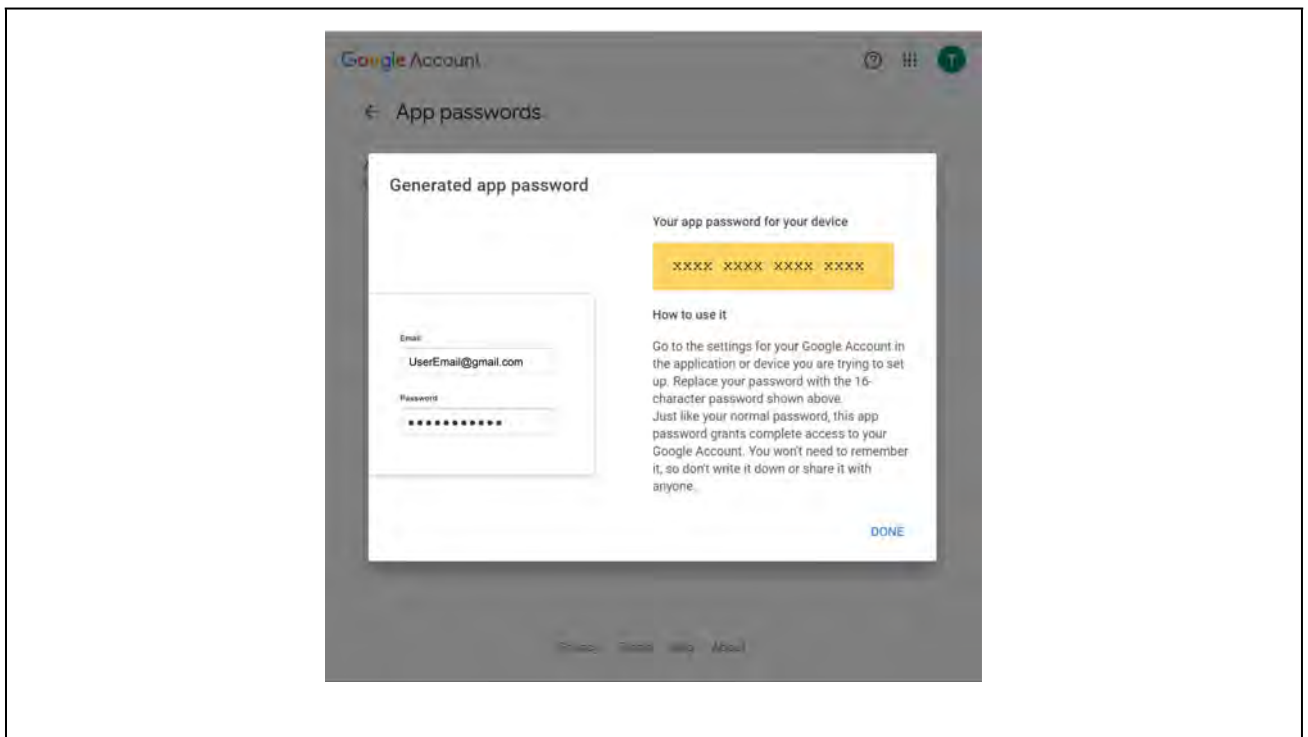

Generate App Passwords

- Repeat steps 4-5 for each device that will be generating email alerts.

Authentication Type

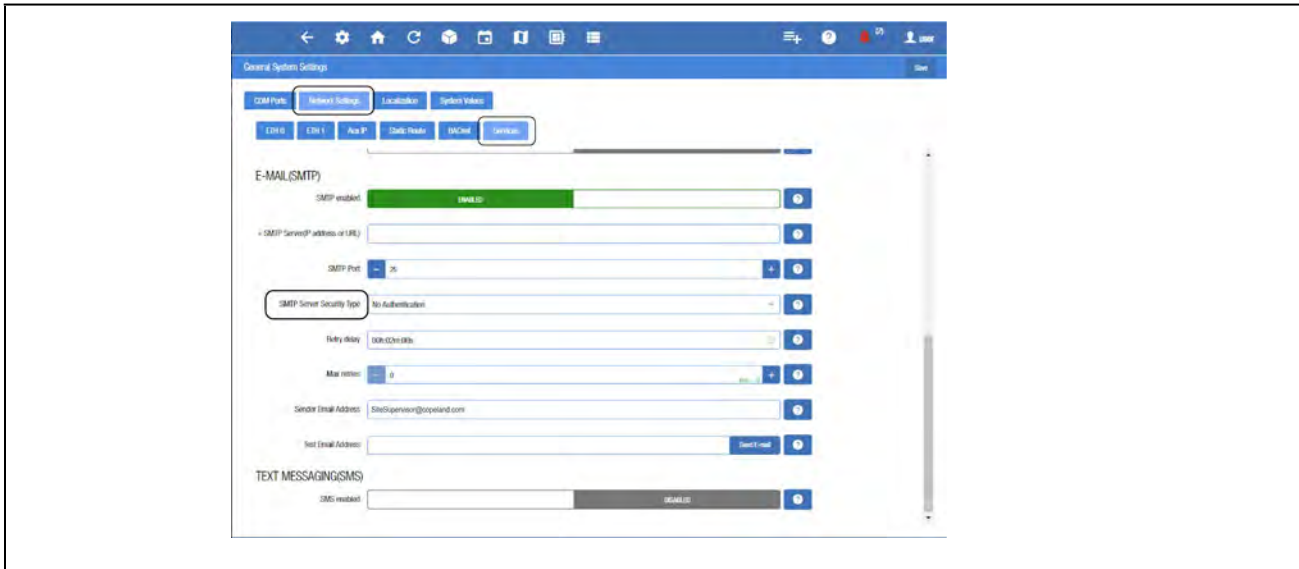

Authentic Type

- Check with the local IT server for the Authentication type to access the SMTP server.
- Set the Username (your email address such as Gmail or Yahoo) and Password (your password for that email account).

Complete SMTP Server - Set Max Retries

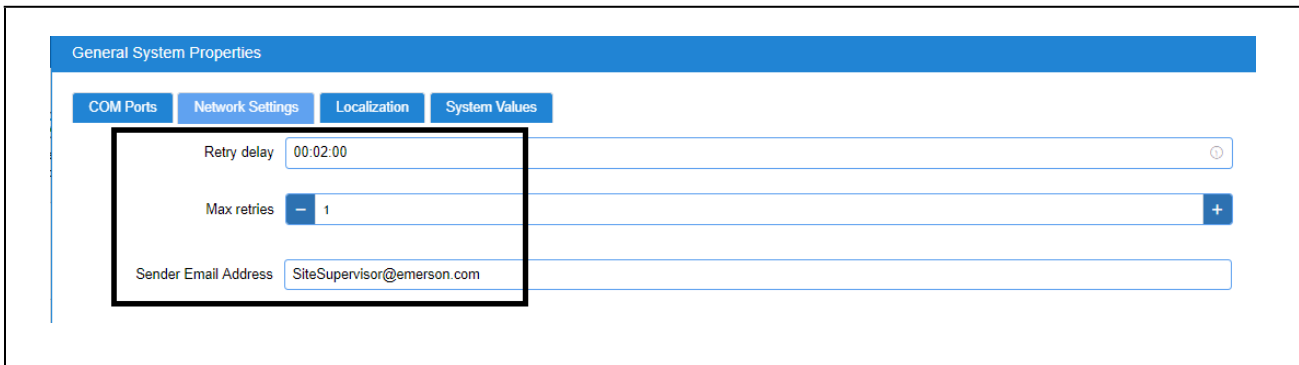

Max Retries

- **Retry delay** - Leave at default setting of 00:02:00
- **Max retries** - Set to 1
- **Sender Email address** - Set the email address the Supervisory Controller will use to send Alarm Communications.

Note: The email address used should be a valid user on the SMTP server.

Text Messaging Setup

Enter the IP Address or DNS from the ISP in the **Domain Name** field:

The screenshot shows the 'General System Properties' configuration page. The 'Network Settings' tab is selected. Under the 'INTERNET (TCP/IP)' section, the 'Domain Name' field is highlighted with a black box. Below it, the 'ETH 0 DHCP Enabled' field is set to 'DISABLED'. The 'ETH 0 IP Address' field contains '192.168.0.250' and the 'ETH 0 Subnet Mask' field contains '255.255.240.0'.

Enter the Domain Name

Enabling SMS Setup

The screenshot shows the 'General System Properties' configuration page, Network Settings tab. The 'TEXT MESSAGING(SMS)' section is highlighted with a black box. It contains the following fields: 'SMS enabled' is a green toggle switch set to 'ENABLED'; 'SMS Max retries' is a numeric field set to '0' with a 'min = 0' indicator and '+'/'-' buttons; 'SMS Retry delay' is a time field set to '00:02:00'; and 'From SMS address' is an empty text field.

SMS Setup

- Under TEXT MESSAGING (SMS), configure the following:
 - **SMS enabled** - Enables or disables the SMS network setup. SMS support must be ENABLED.
 - **SMS Max retries** - Set the maximum number of retries for SMS Alarm Communications to 1.
 - **SMS Retry delay** - Set the time interval between each retry. Leave at default setting of 00:02:00.
 - **From SMS address** - Set the SMS address that will send SMS to mobile phones. This is determined by the mobile phone number and mobile service provider used. Check with the local network provider to determine the SMS gateway address.

Managing Users

1. Click the **Setup** (gear)  icon.
2. Click **Configure System**.
3. Click **Manage Users**.

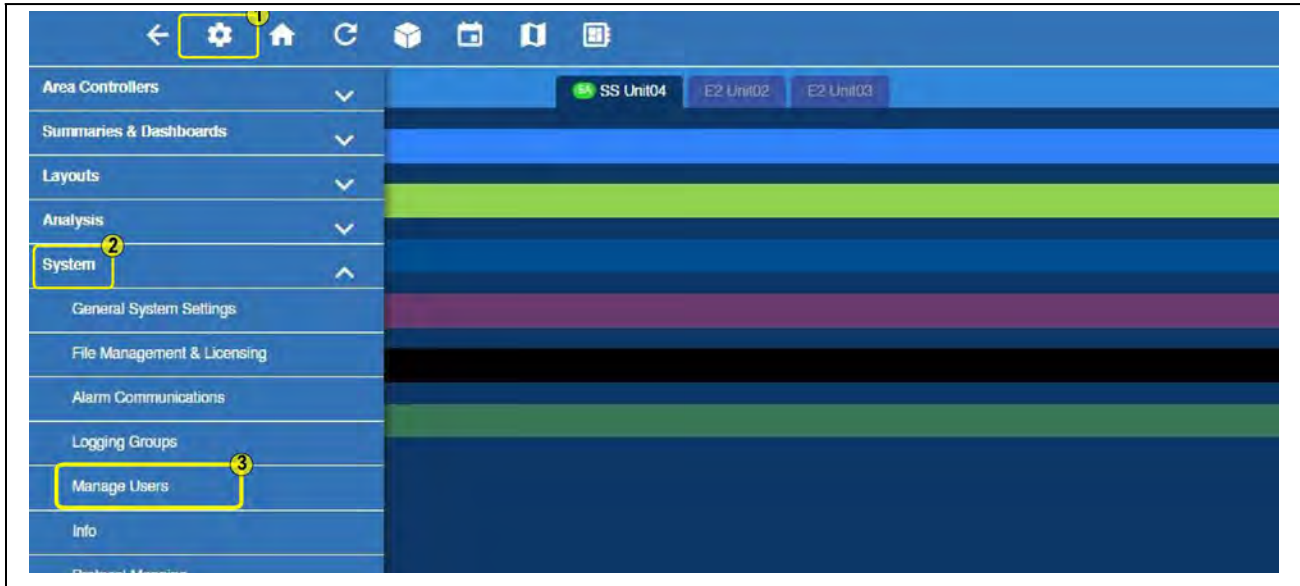

Managing Users

View and Edit Users

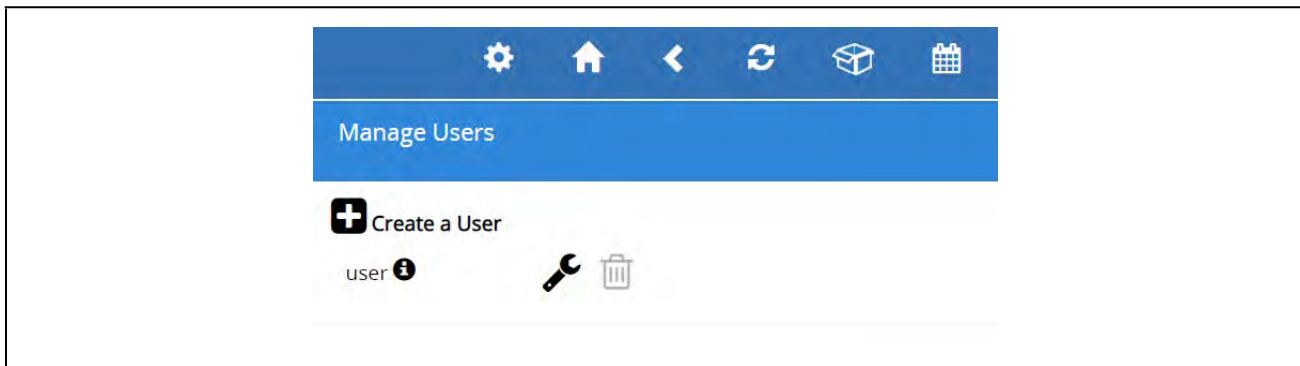

Default User Profile

- From here, you can view, edit, or delete users.
- To add a user, click the **plus (+) sign** and **Create a User**.
- To edit a user, click the wrench icon .
- To delete a user, check the box on the left side of the user name and click the **Delete** button.

Create New User

1. Click **Create a User**.
2. The below fields are required:
 - User Name
 - Actual Name
 - Password
 - Confirm Password

The screenshot shows the 'Manage Users' interface with the 'Create a User' form. The form is divided into several sections:

- User Information:** Fields for 'User Name', 'Actual Name', 'Password', and 'Confirm Password'. A dropdown for 'Auto Logout Time' is set to 'Using system configuration'.
- Contact Information:** Fields for 'Email', 'Office Phone', and 'Mobile Phone(SMS)'.
- User Information:** A 'Select User Role' section with radio buttons for 'Energy Manager', 'Non-Technical End User', 'Monitoring Staff', 'Technician', 'System Admin', and 'Create a User Role' (which is selected). A 'User Description' text area is also present.

Create New User

Note: The User Name and Password created here can be used to log into the Supervisory Controller.

This close-up shows the 'Contact Information' section of the form. It contains three input fields:

- 'Email' with a text input box.
- 'Office Phone' with a text input box.
- 'Mobile Phone(SMS)' with a text input box.

Contact Information

Note: These fields can be left blank if this user will not be receiving Alarm Communications via email or SMS.

3. Contact information for the user must be filled out for them to receive Alarm Communications via email or SMS.
 - Email (Note to verify the email address is valid to receive emails)
 - Mobile Phone (SMS) (Note to verify the mobile phone number is correct and in the following format: phone_number@carrier_txt_domain (55512345678@txt.att.net))
 - Office Phone

Below are examples of SMS addresses for those in the United States:

- T-Mobile: phonenumber@tmomail.net
- Virgin Mobile: phonenumber@vmobl.com
- Cingular: phonenumber@cingularme.com
- Sprint: phonenumber@messaging.sprintpcs.com
- Verizon: phonenumber@vtext.com
- Nextel: phonenumber@messaging.nextel.com
- U.S. Cellular: phonenumber@email.uscc.net
- Cricket: phonenumber@sms.cricketwireless.net
- Boost Mobile: phonenumber@smsmyboostmobile.com
- AT&T: phonenumber@txt.att.net
- *phonenumber* = your 10-digit phone number

Note: The Contact Information fields can be left blank if the user will not be receiving Alarm Communications via email or SMS (See **Contact Information**).

User Information and Rules

4. The **User Information** area allows the user's login access level to be set. Depending on the selected role, the user can View, Control, Configure, or Administer items listed in the action area for that role.

To view more details about what each role can do, click the  icon next to the role name.

5. Click **Save**.

Alarm Communications

1. Click the **Setup** (gear) icon > **System**.
2. Select **Alarm Communications**.

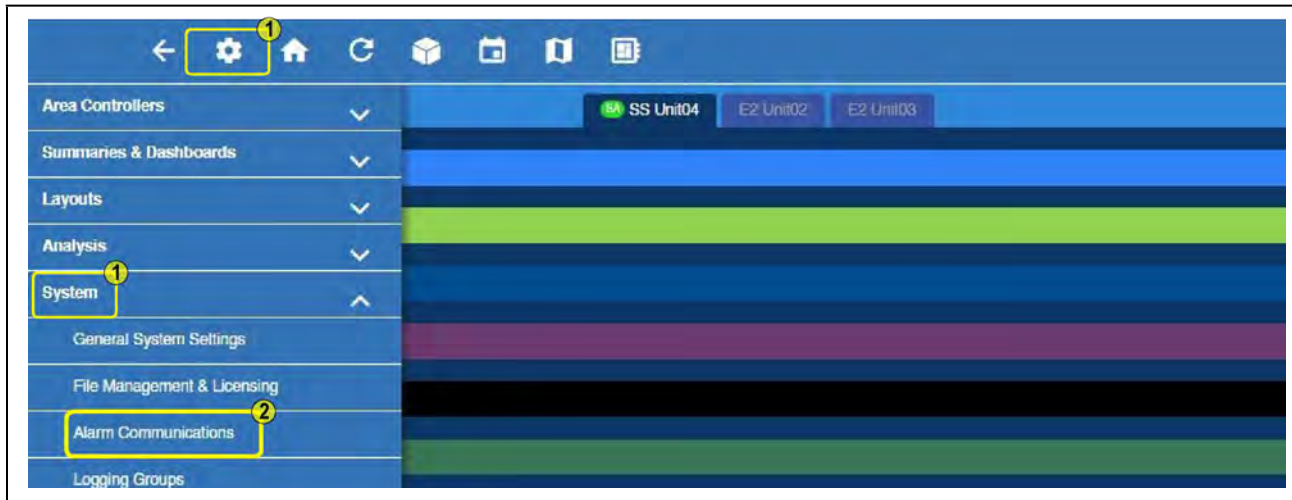

Alarm Communications

3. Click **Add an Alarm Notice** to create a new Alarm Notice.



Add an Alarm Notice

Note: It is assumed that role-based user access is already set up at this stage. Otherwise, role-based user access must be configured (See **Contact Information**).

Creating an Alarm Notice

1. Click **Edit** and enter a unique name for the alarm notice.
2. Select the desired options to filter the alarm notice. They can be filtered via Category, Alarm Type, and Resolution:

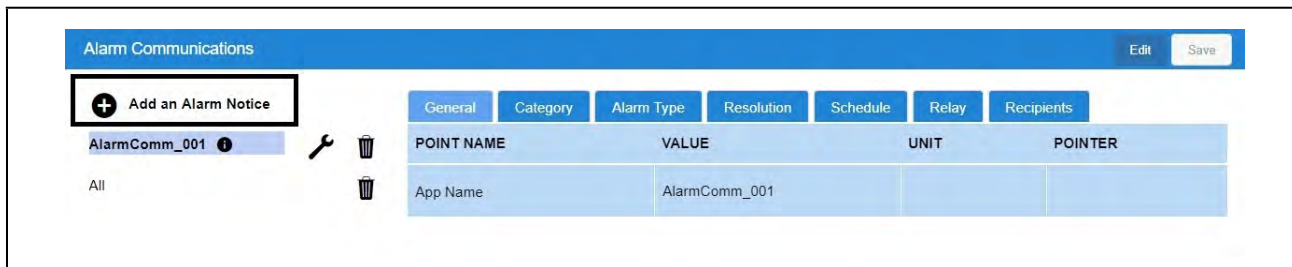

Create an Alarm Notice

3. **Add Users** will list the available users created in **Manage Users**.
4. Click the **Recipients** tab to see a list of users already set up in the system - from here you can choose the communication type they should receive (email, SMS).

If a user has no email or mobile contact information available, **Not set** will appear next to the user name.

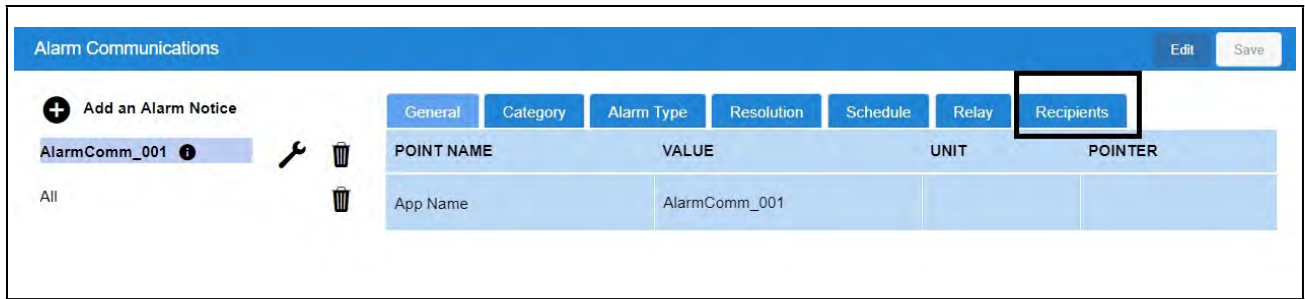

Recipients Tab

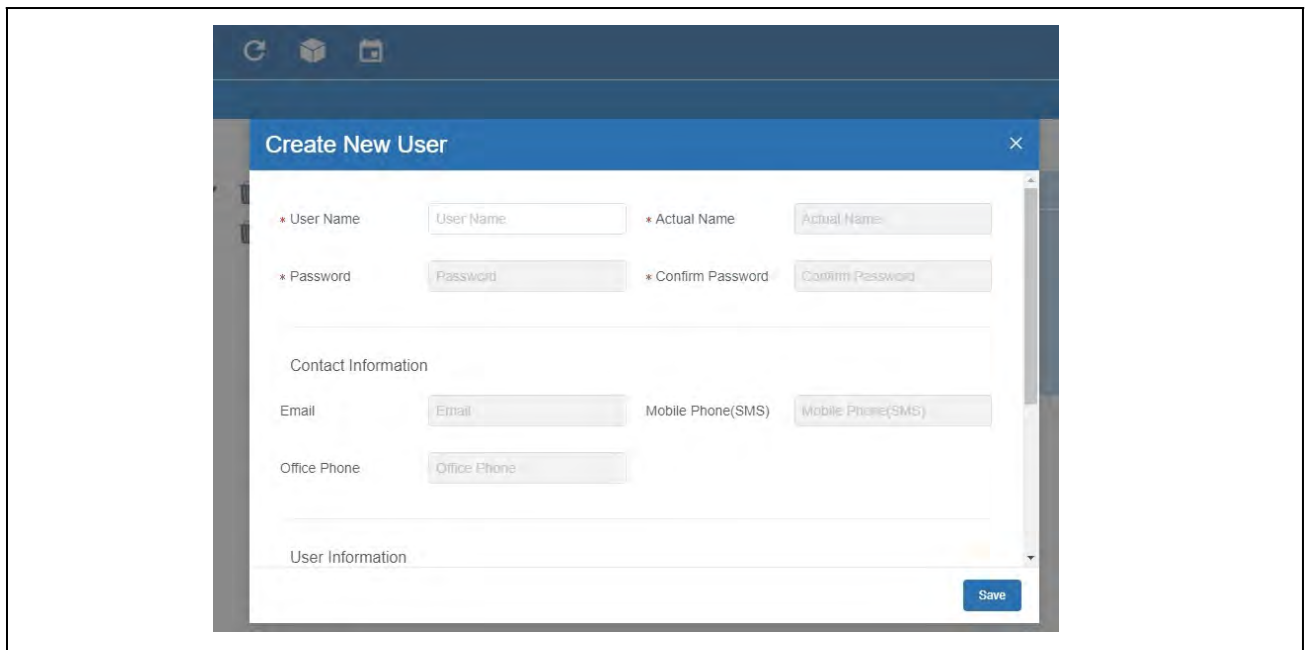

Create New User (Optional)

5. If you wish to receive notifications and it has not yet been set up, click **Create New User** and fill out all of the appropriate fields. Select **Email and/or SMS**.

Add Users

Manage Users

+ Create a User
user ⓘ

* User Name * Actual Name

* Password * Confirm Password

Contact Information

Email Mobile Phone(SMS)

Office Phone

User Information

* Select User Role: Energy Manager ⓘ Non-Technical End User ⓘ Monitoring Staff ⓘ Technician ⓘ System Admin ⓘ [+ Create a User Role](#)

User Description

Add Users

1. Select the user who will be notified by Alarm Communications. Check the appropriate boxes to enable the email and/or SMS notification.

Alarm Communications

+ Add an Alarm Notice

AlarmComm_001 ⓘ

All

General Category Alarm Type Resolution Schedule Relay Recipients

| POINT NAME | VALUE | UNIT | POINTER |
|------------|---|------|---------|
| | <input type="checkbox"/> All <input type="checkbox"/> user <input type="checkbox"/> E-mail <input type="checkbox"/> SMS | | |

Create New User

Add Users Checkbox

2. Notifications will be sent to the email address and/or mobile phone number provided in the user's contact information.

Appendix D: Utility Monitoring

The Supervisory Controller is capable of configuring a Utility Monitoring application that is used primarily for monitoring, recording, and to a lesser degree controlling power or KW usage in a building. Utility Monitoring applications are pre-programmed with extensive logging capabilities that record the hourly, daily, and monthly power usage statistics. Several power monitoring input types can be used, it can be KW Analog, Pulse KWH or Energy device. The following document will serve as a guide for setting up Utility Monitoring in the Supervisor.

How to Create a Utility Monitoring Application

1. Log in to Supervisory Controller by selecting **Login** located at upper right-hand side of screen. The default Username is user and Password is supervisor.



Log Into the Supervisory Controller

2. From the Home screen, select the **Control Inventory** icon.

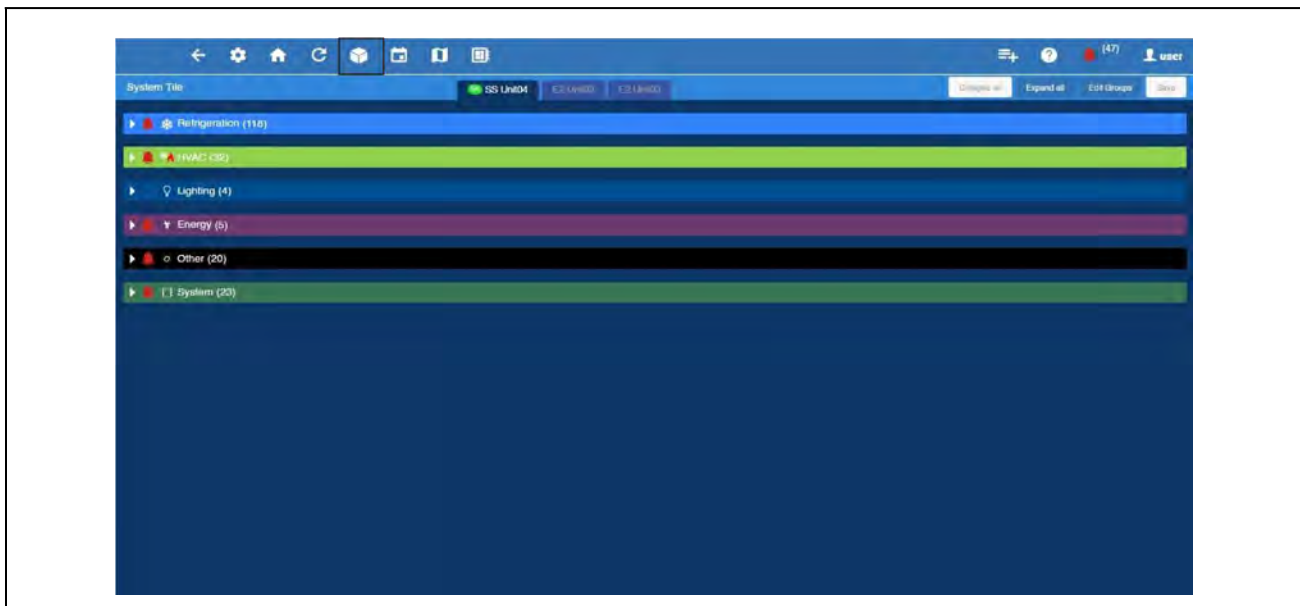

Select Control Inventory

- Select **Energy**, click **Add Control**, and then select **Utility Monitoring**.

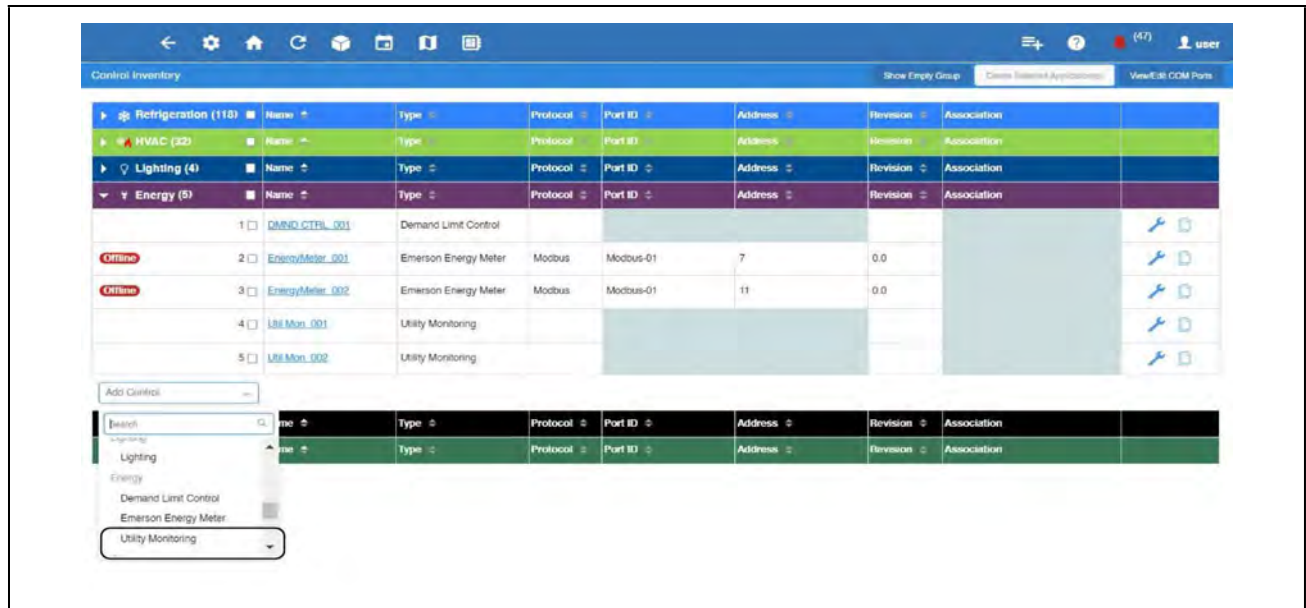

Select Utility Monitoring

- In the **Name** field, enter the name of the application and then click the arrow icon to close edit mode. In this example, add one (1) Utility Monitoring application.

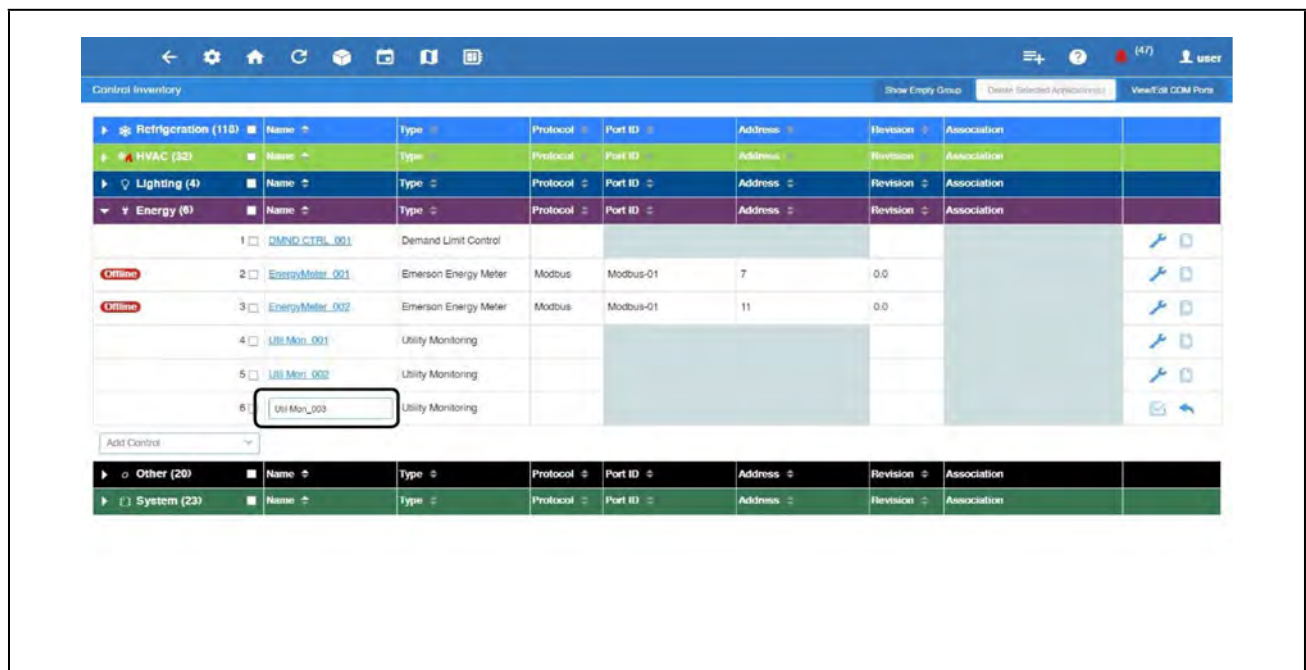

Utility Monitoring Application

- Click the **Utility Monitoring** application for details.

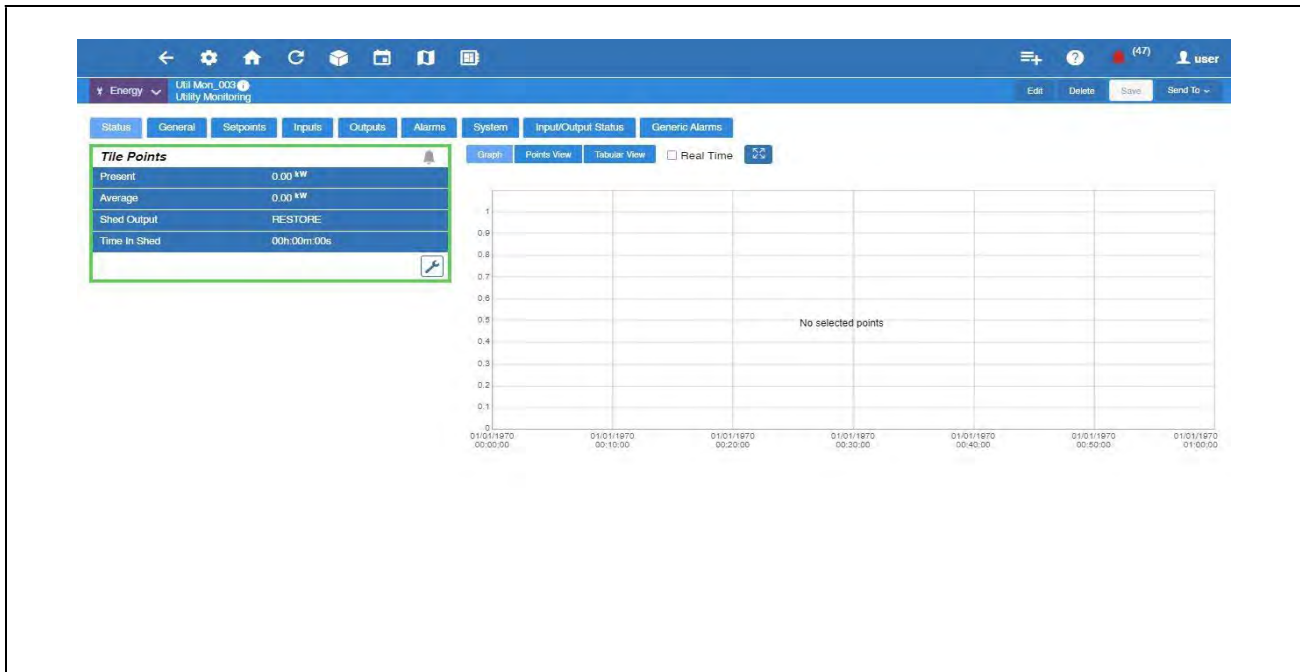

Utility Monitoring Application Details

How to Add and Commission the Energy Meter



Energy Meter

If an Energy Meter will be used, the following steps shows how to add and commission the device. Access the Energy Meter User Guide (P/N 026-1726) [here](#).

1. From the Home screen, select the **Control Inventory** icon.

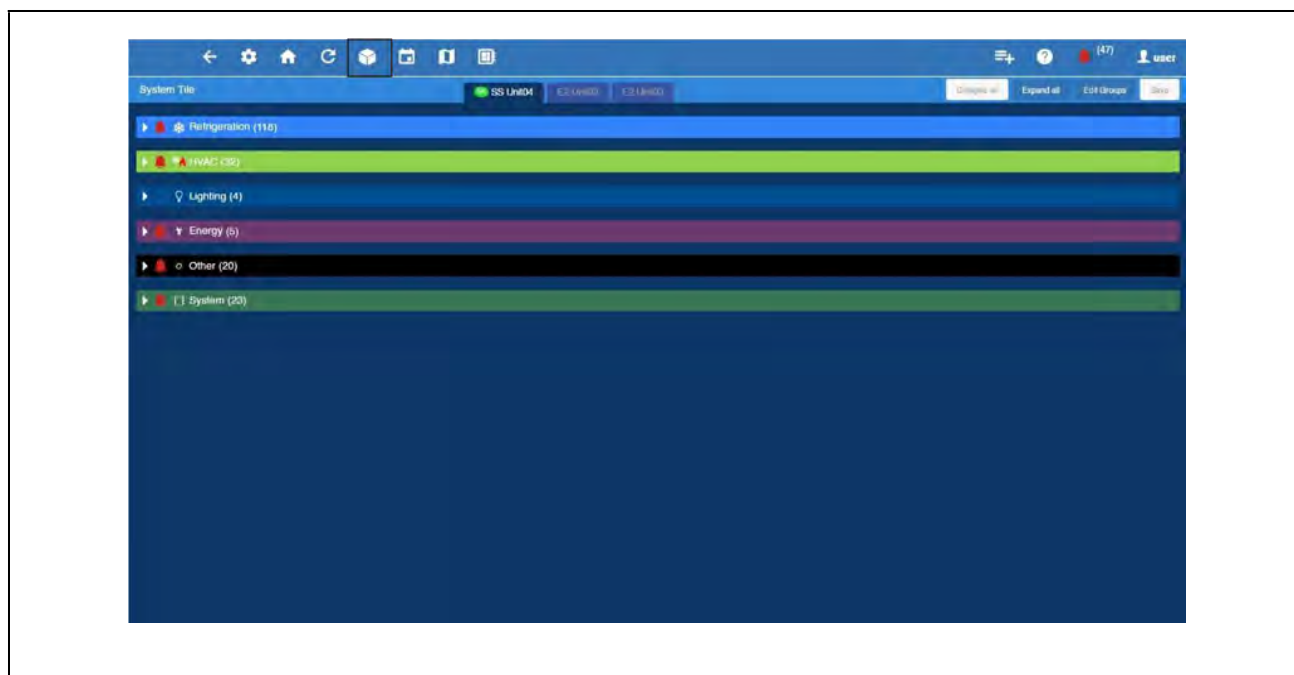

Select Control Inventory

2. Go to **Energy**, click **Add Control**, and then select **Energy Meter**.

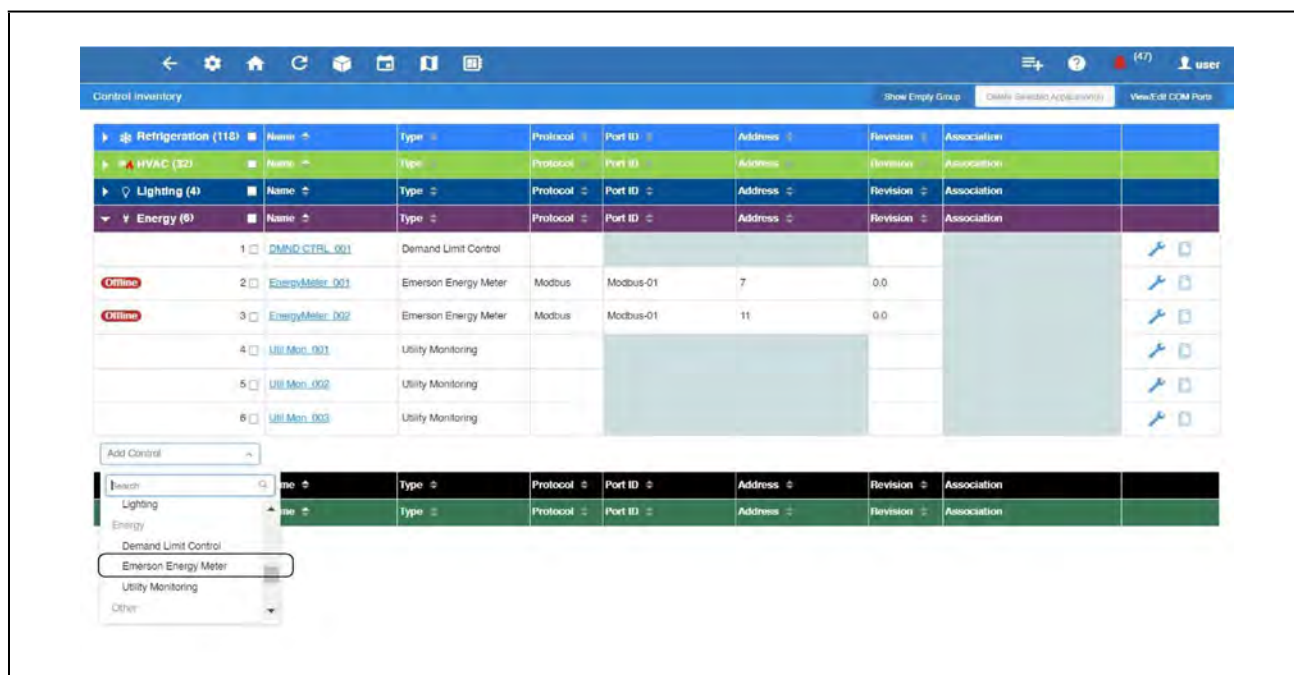

Select Energy Meter

- Enter the **Name** on the name field, select the **Port ID** and network Address of the device and then click the check icon to commission. In this example, add one (1) Energy Meter application.

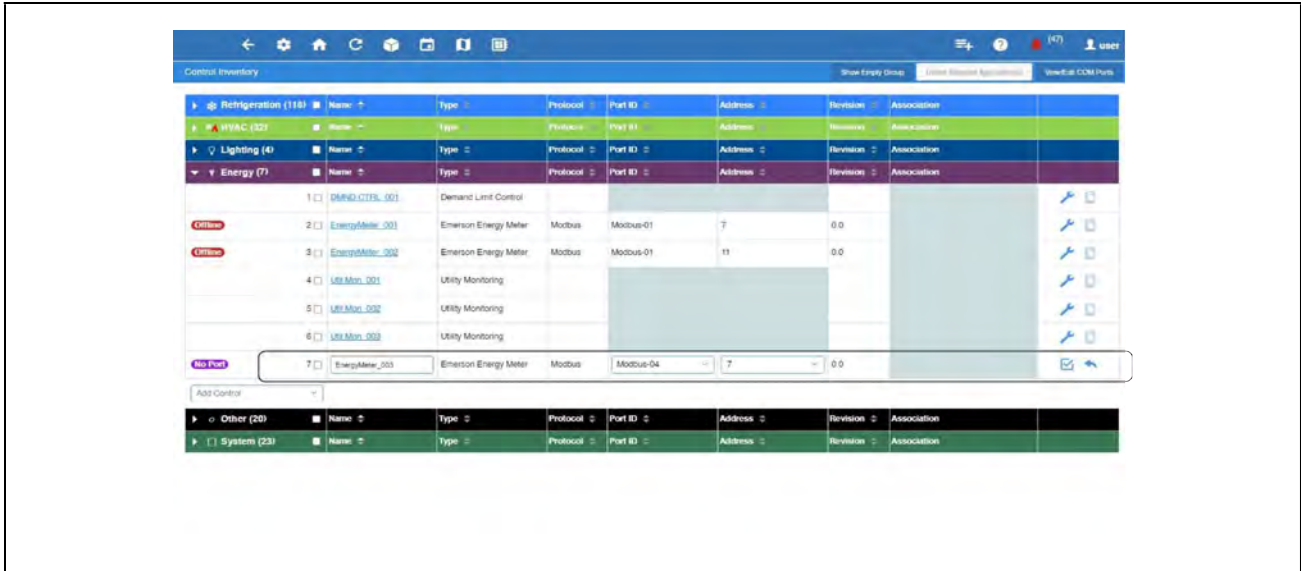

Energy Meter Application

- Verify if the device is already ONLINE.

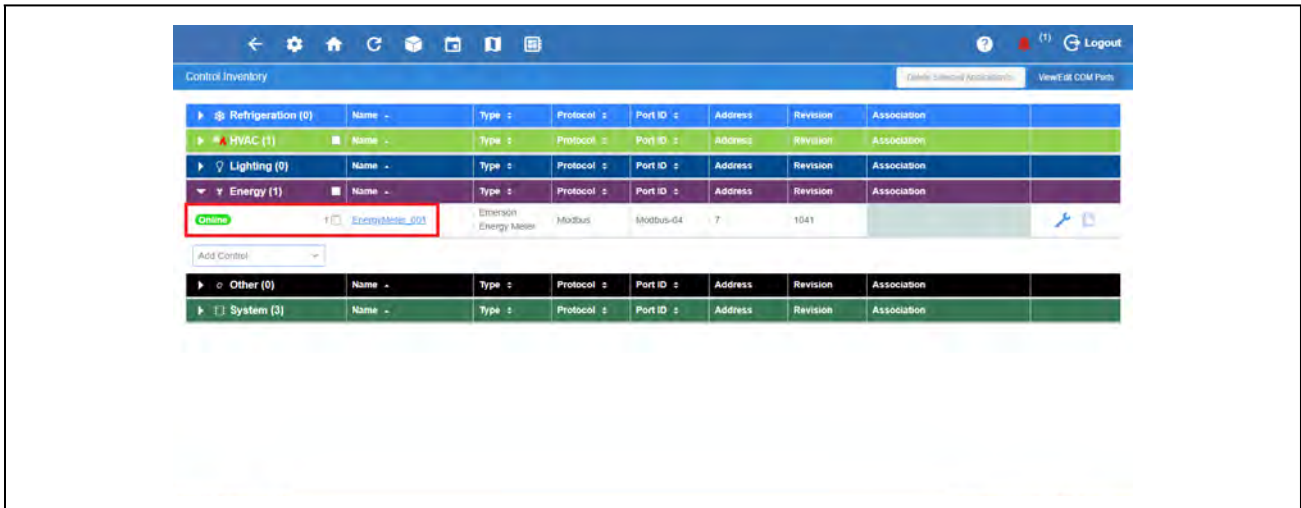

Energy Meter Application Details

Getting Started - Basic Setup for Utility Monitoring

Several power monitoring input types can be used:

- KW Analog
- Pulse KWH
- Energy device

Each has to be configured correctly for it to work. The following shows how to set up each type. Scroll down to the input type to be used on the system.

How to Configure a KW Analog Power Monitoring Input

1. From the Home screen, select the **Control Inventory** icon.

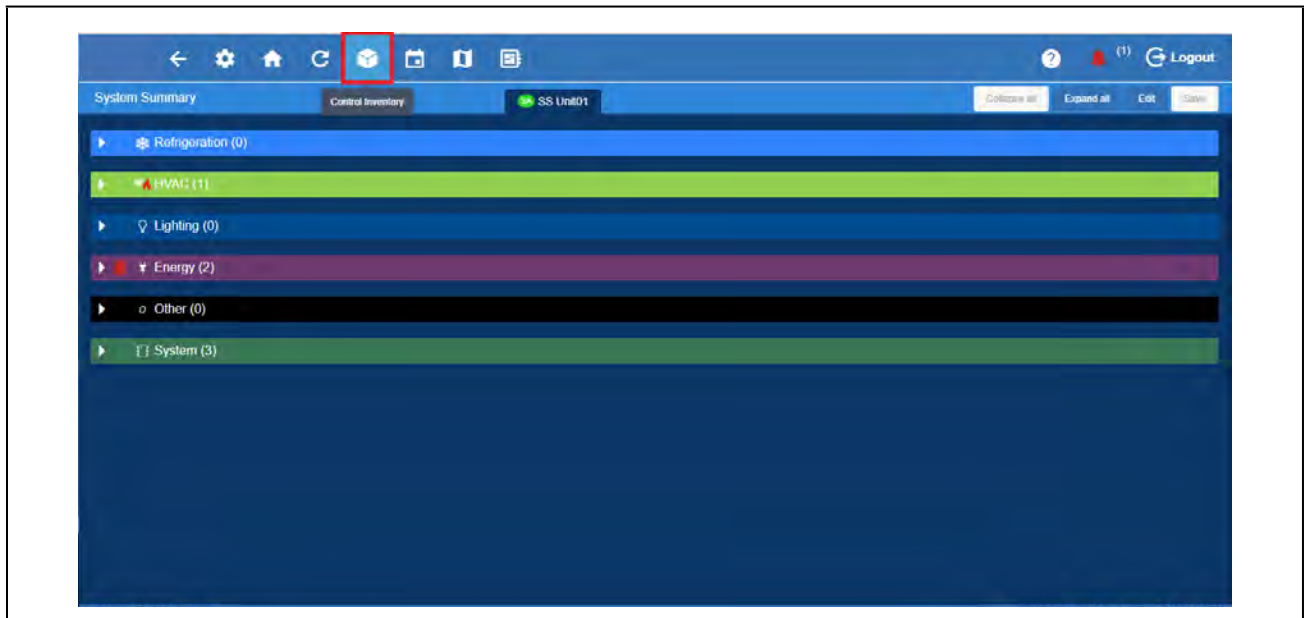

Select Control Inventory

2. Go down to **System**, click **Add Control** and select **IPX 25 Relay**.

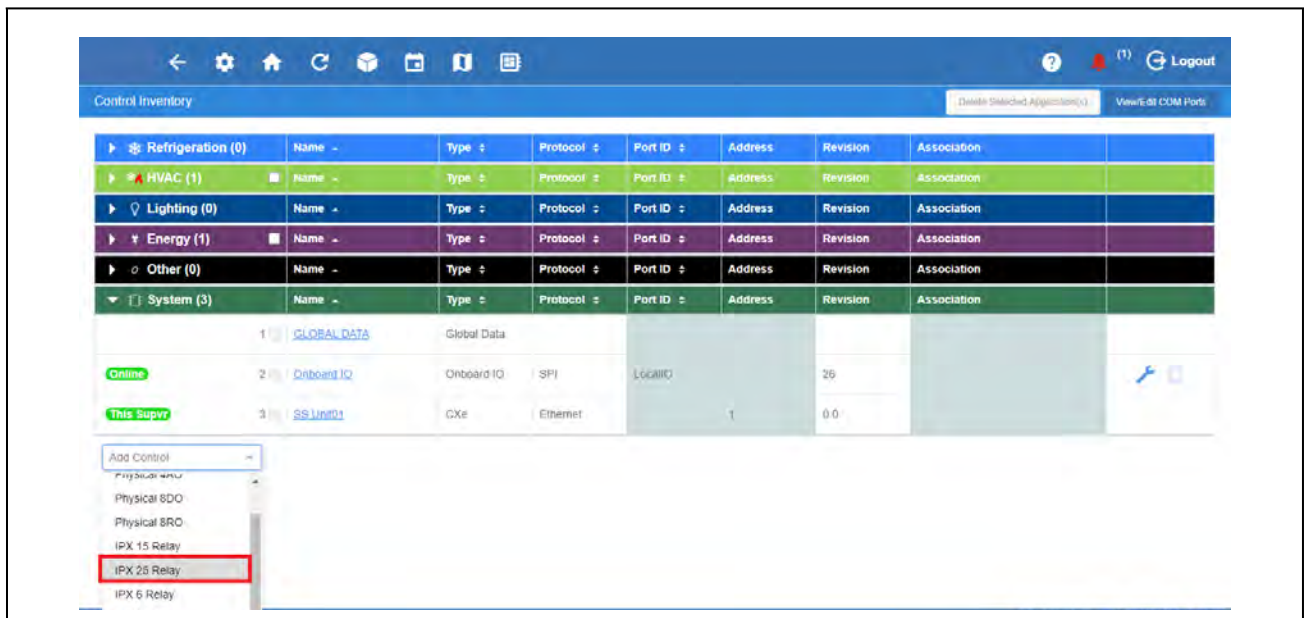

Select IPX 25 Relay

- Enter the **Name** on the name field, select the Port ID and network Address of the device and then click the Check icon to commission. In this example, add one (1) IPX25D Relay.

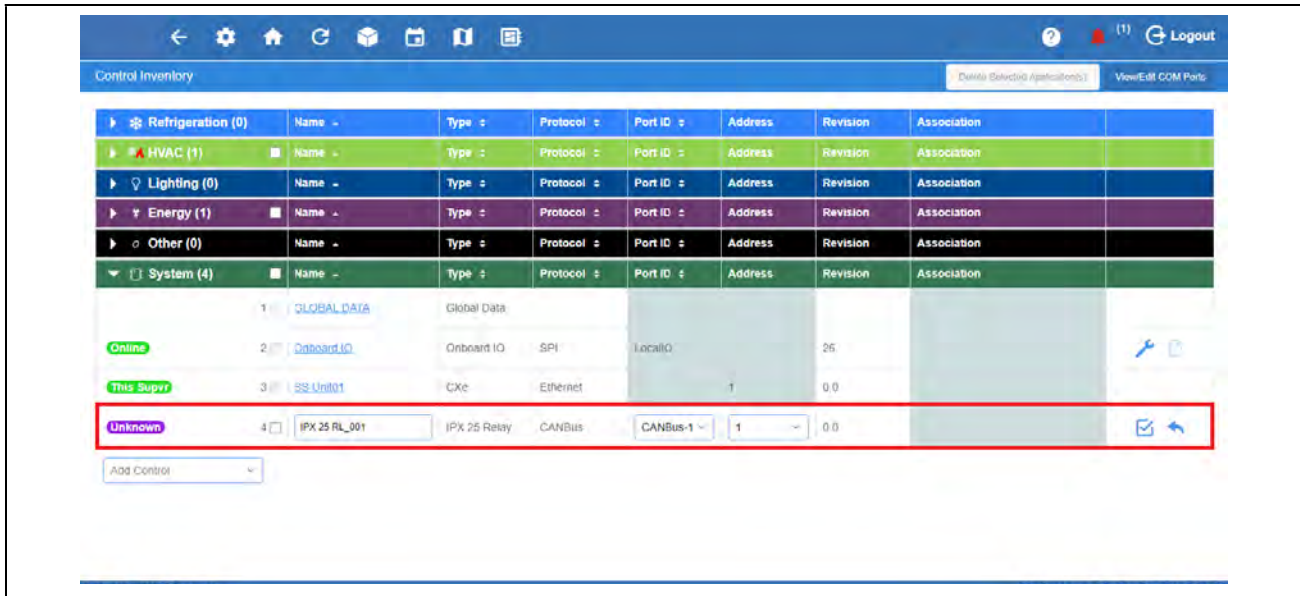

IPX 25 Relay Application

- Click the **IPX 25**.

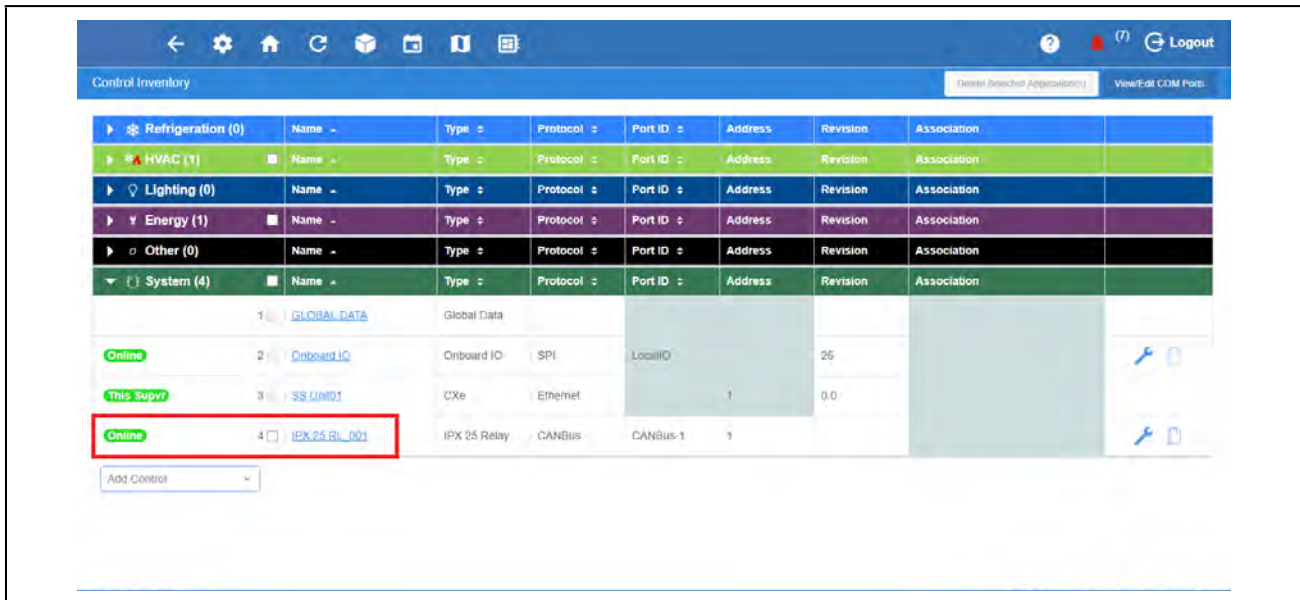

IPX 25 Application Details

5. Go to **Setup** and click **Edit**.

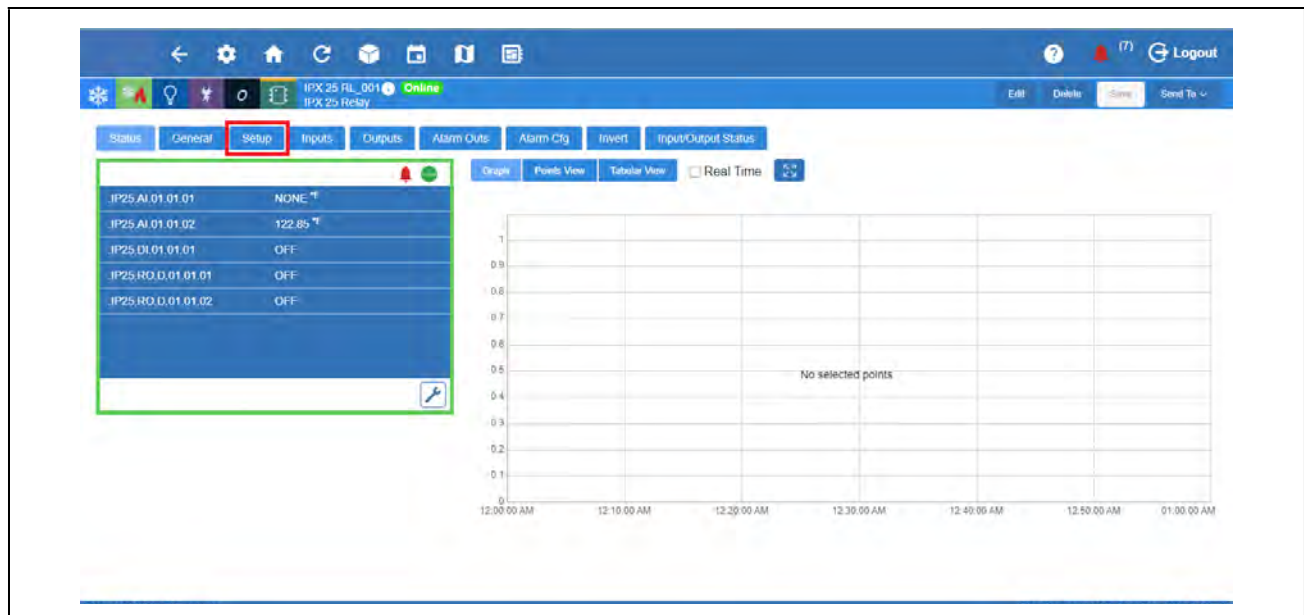

Go to Setup

6. Scroll down to the value and pointer where the Analog KW signal will be connected to. Set the kind of input and engineering unit. For this example, set **Conf AI01 to 0-5V**. Then, set **CfgAI01_EU to None** and select **Save**.

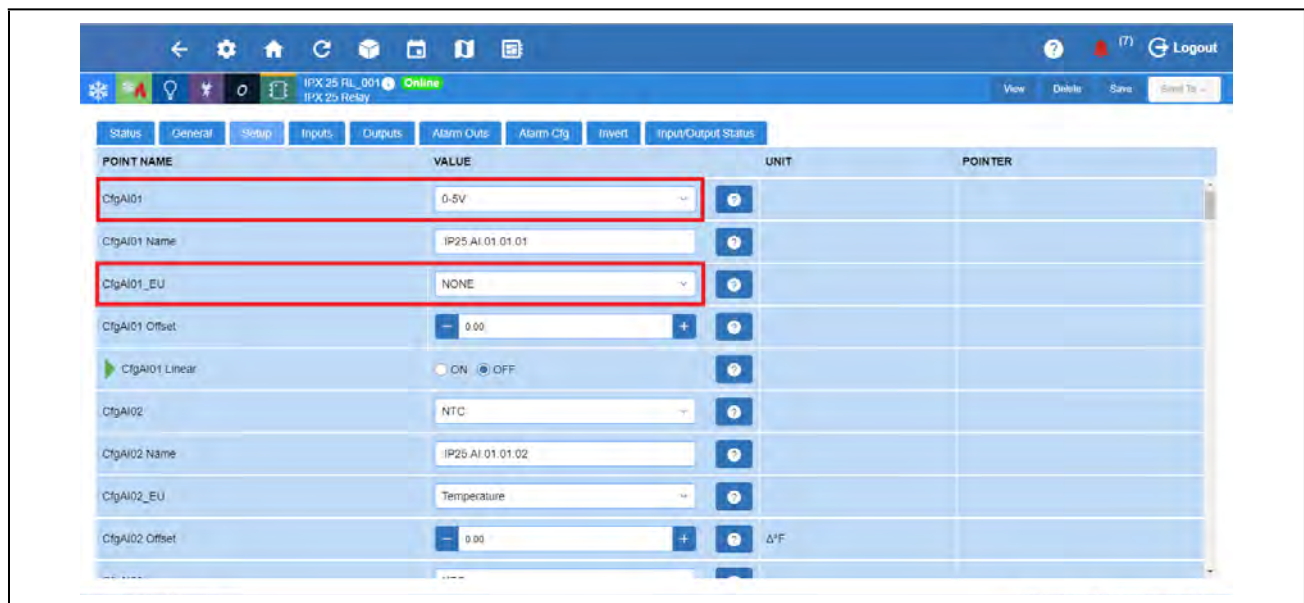

Setup Tab Parameters

7. Now, select the **Energy** icon and select **Utility Monitoring**. The default name for application is **Util Mon_#**.

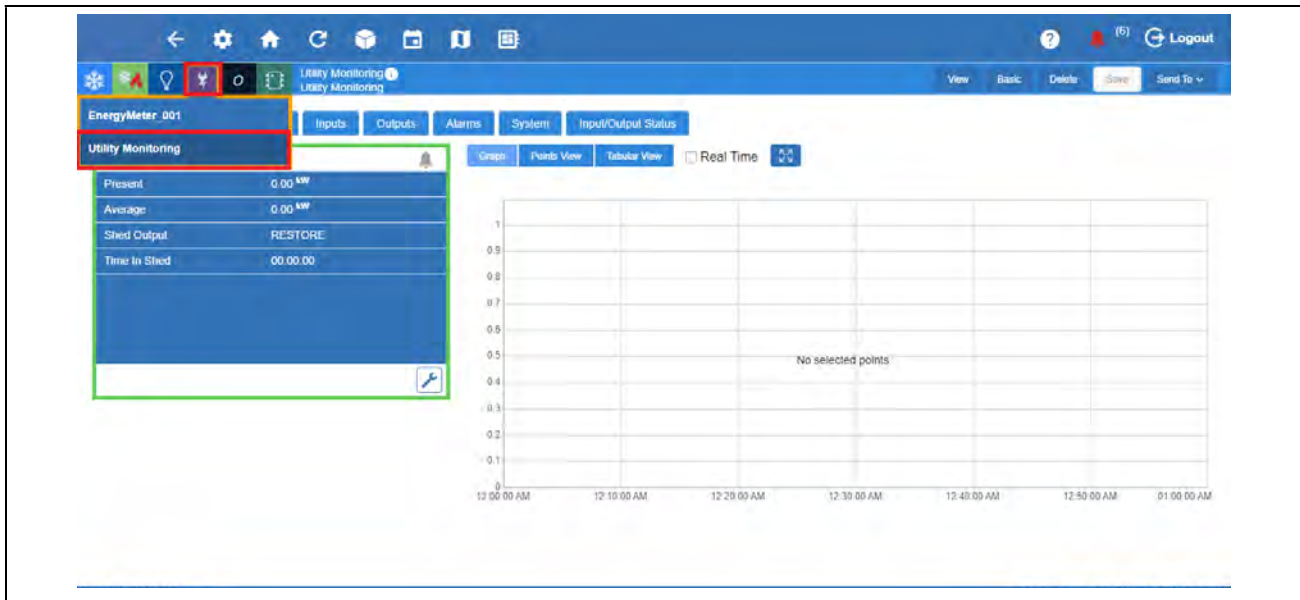

Select Utility Monitoring

8. Go to **General**, click **Edit** and then **Advanced**.

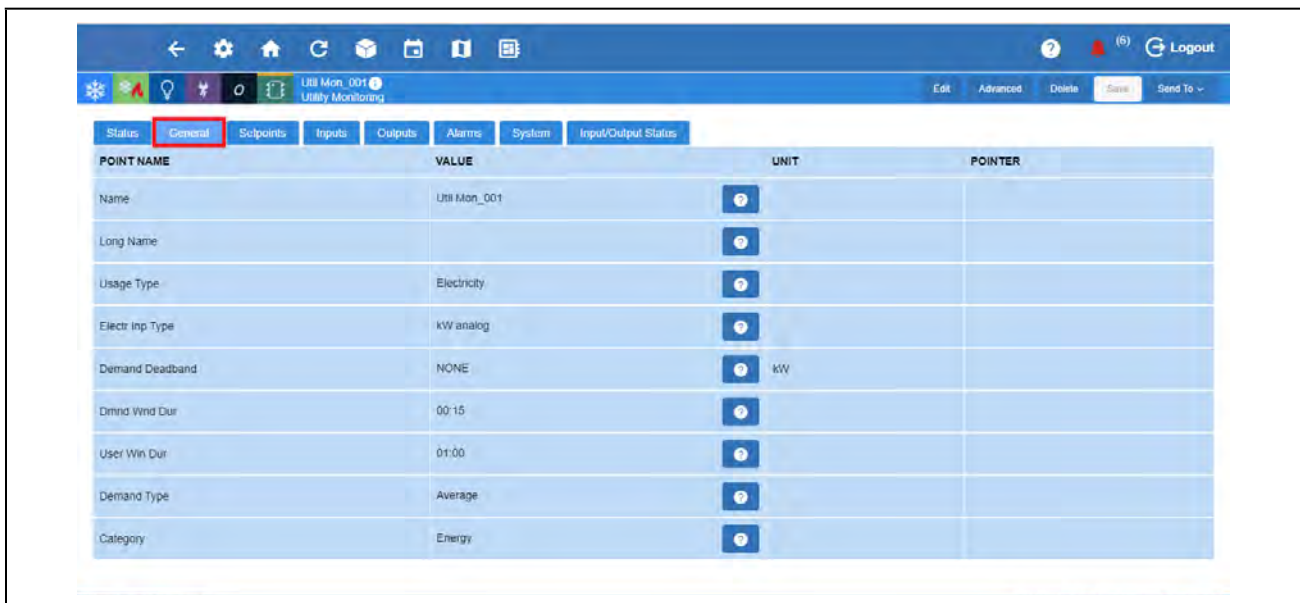

Go to General Tab

9. Specify the **Name** for this application. Under **Usage Type**, select **Electricity** and **Electr Inp Type** to **kW analog**. Select **Save**.

| POINT NAME | VALUE | UNIT | POINTER |
|-----------------|--------------------|------|---------|
| Name | Utility Monitoring | | |
| Long Name | | | |
| Usage Type | Electricity | | |
| Electr Inp Type | kW analog | | |
| Demand Deadband | NONE | kW | |
| Demnd Wind Dur | 00:15 | | |
| User Win Dur | 01:00 | | |
| Demand Type | Average | | |
| Month Start Day | 1 | | |
| Category | Energy | | |

General Tab Parameters

10. Go to Inputs, click the right arrow-button. Configure the **Target and Property** for the Analog Input by clicking the drop-down arrow beside it.

| POINT NAME | VALUE | UNIT | POINTER |
|------------|---------|------|---------|
| INPUT | 0.00 | kW | |
| ENABLE | ENABLED | | |

Go to Inputs Tab

11. Under **Target**, select the device where your KW Analog is to be found. This could be an IPX Relay board or an Onboard IO.

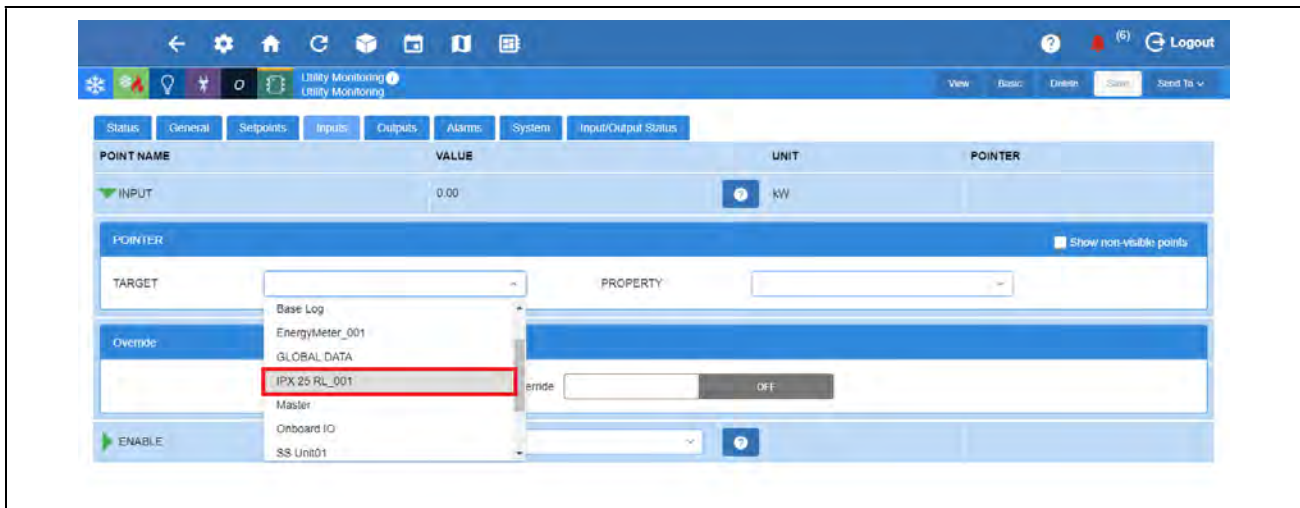

Select Device

12. Under **Property**, select the pointer where the KW Analog is connected to and select **Save**.

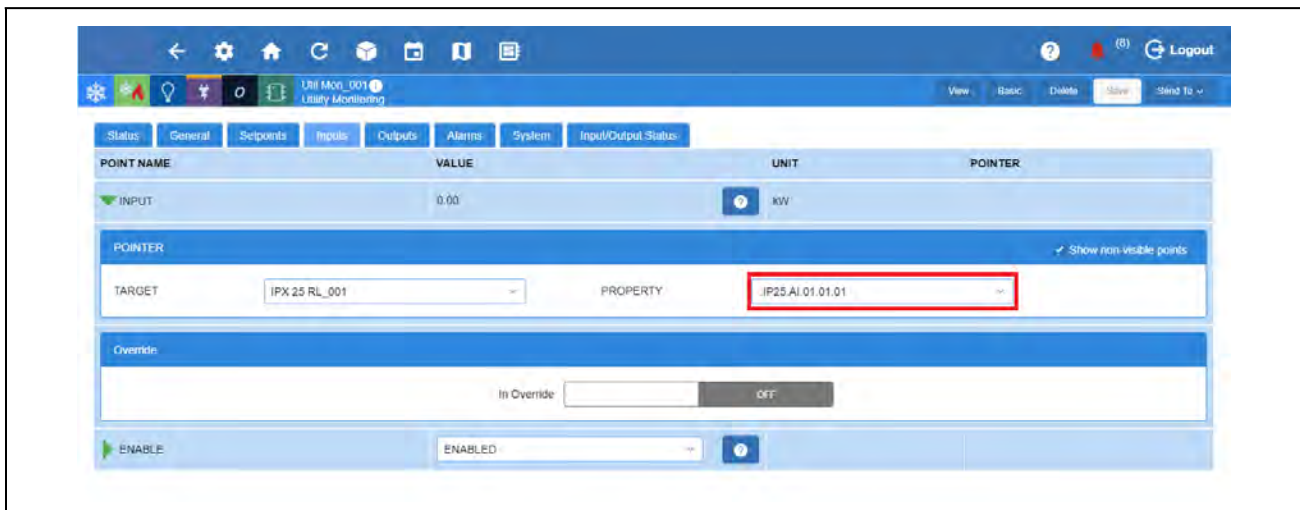

Select Pointer

How to Create a Utility Monitoring Application

1. From the **Home** screen, select the **Control Inventory** icon.

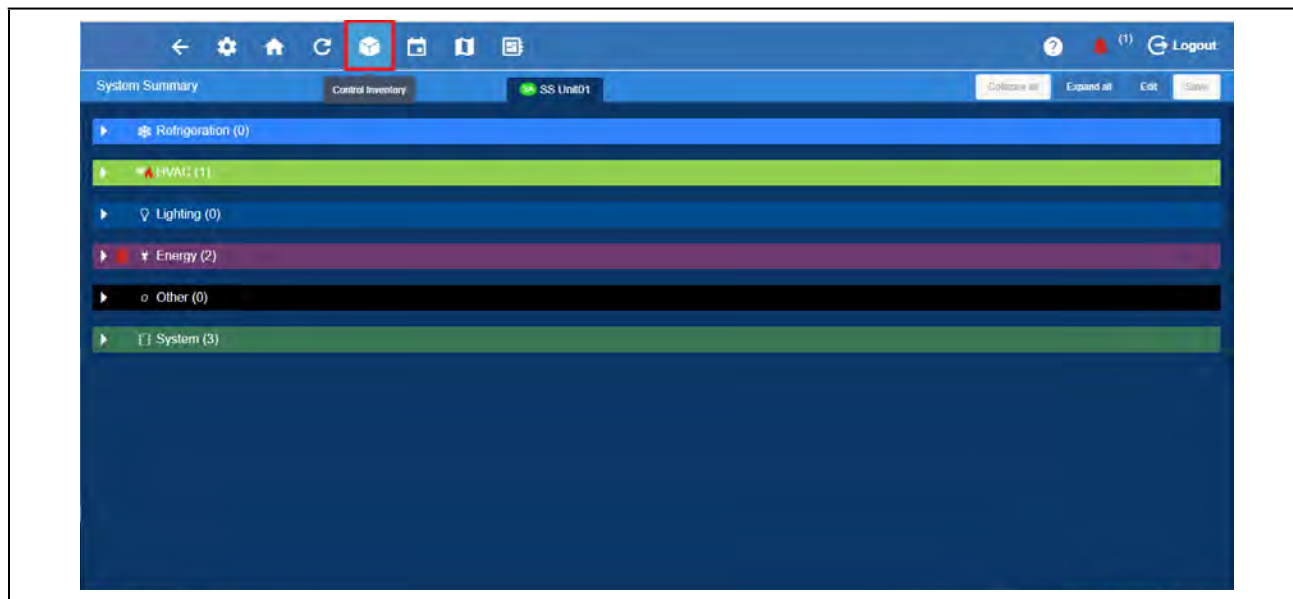

Select Control Inventory

2. Go down to **System** and select **Onboard IO**.

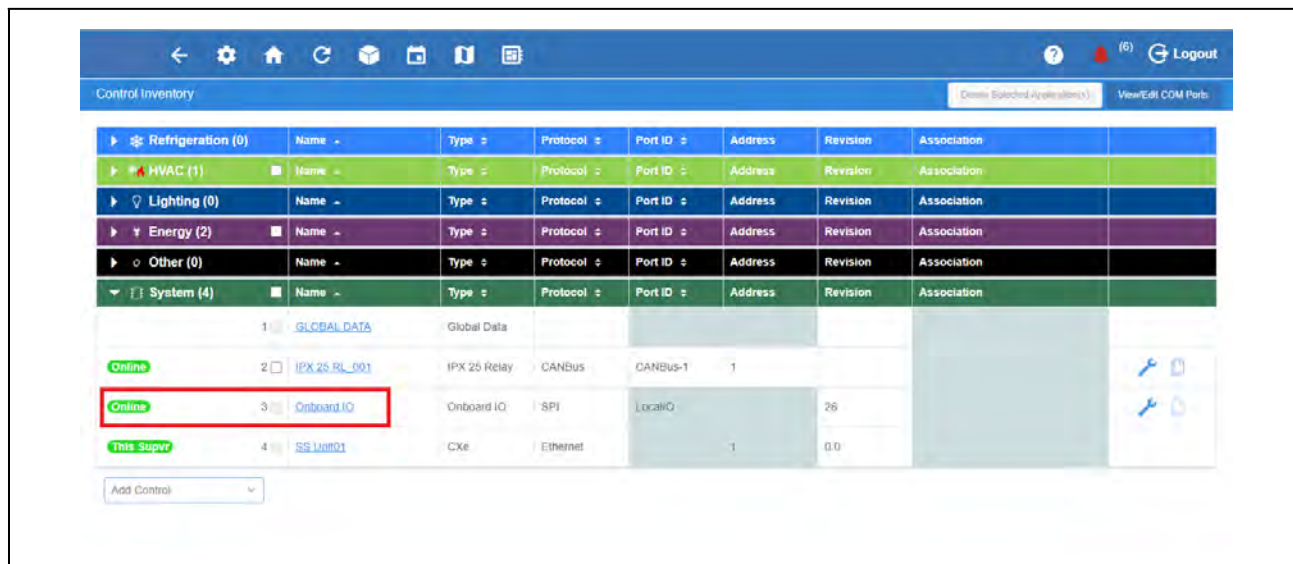

Select Onboard IO

3. Go to **Setup**, click **Edit** and **Advanced**.

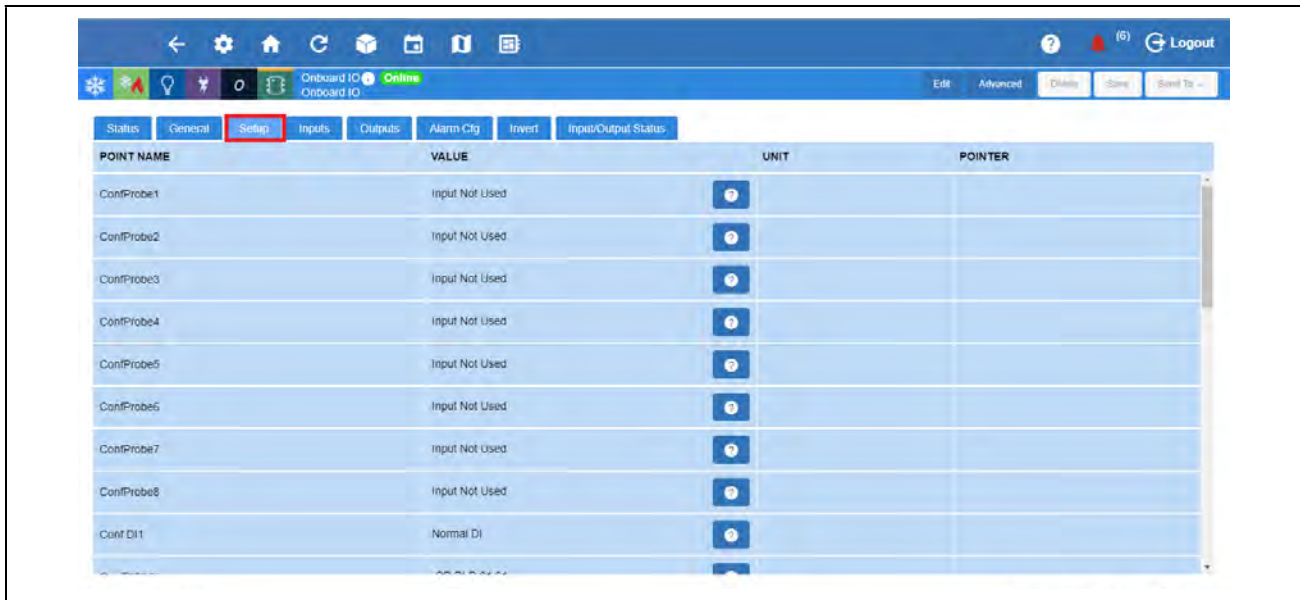

Go to Setup Tab

4. Scroll down to **Conf DI1**, select **Pulse Counter** and click **Save**.

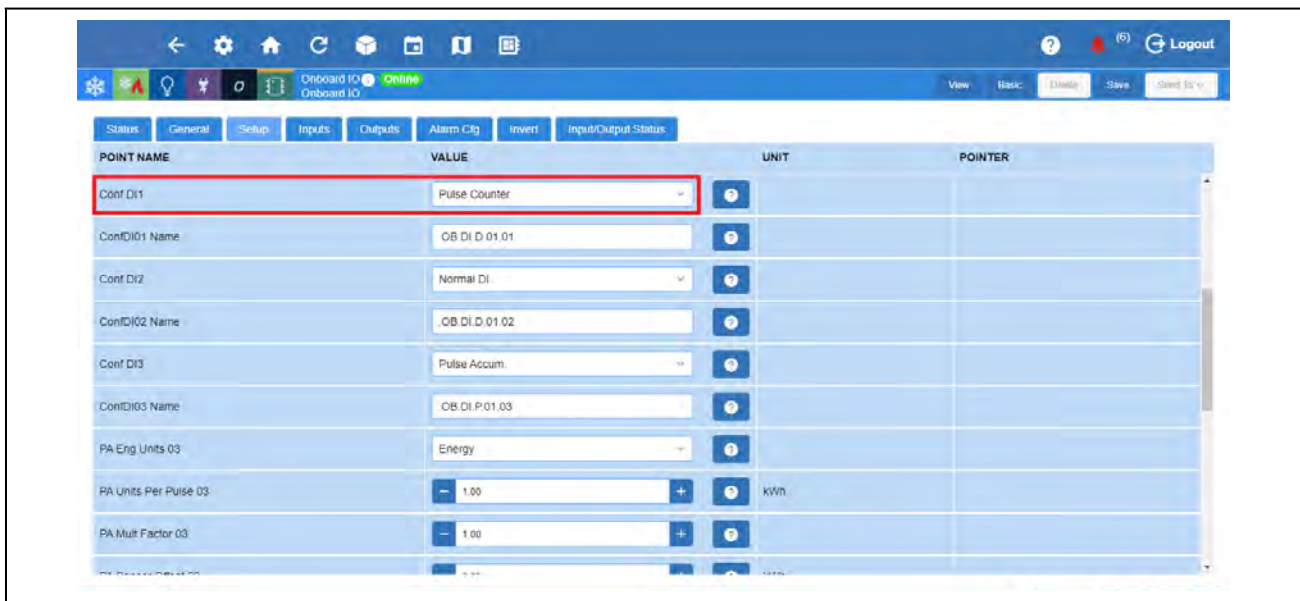

Select Pulse Counter

- Select the **Energy** icon and click the **Utility Monitoring** to be configured.

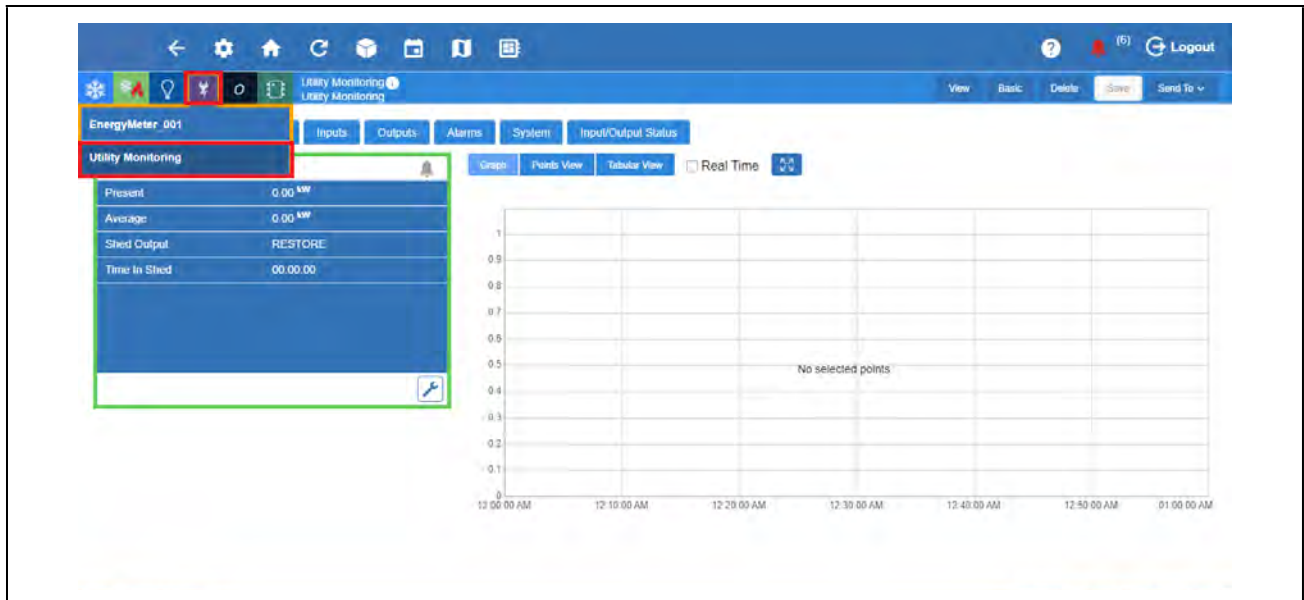

Select Utility Monitoring

- Go to **General**, specify the **Name** for this application. Under **Usage Type**, select **Electricity**. Under **Electr Inp Type**, select **kWh pulse** and click **Save**.

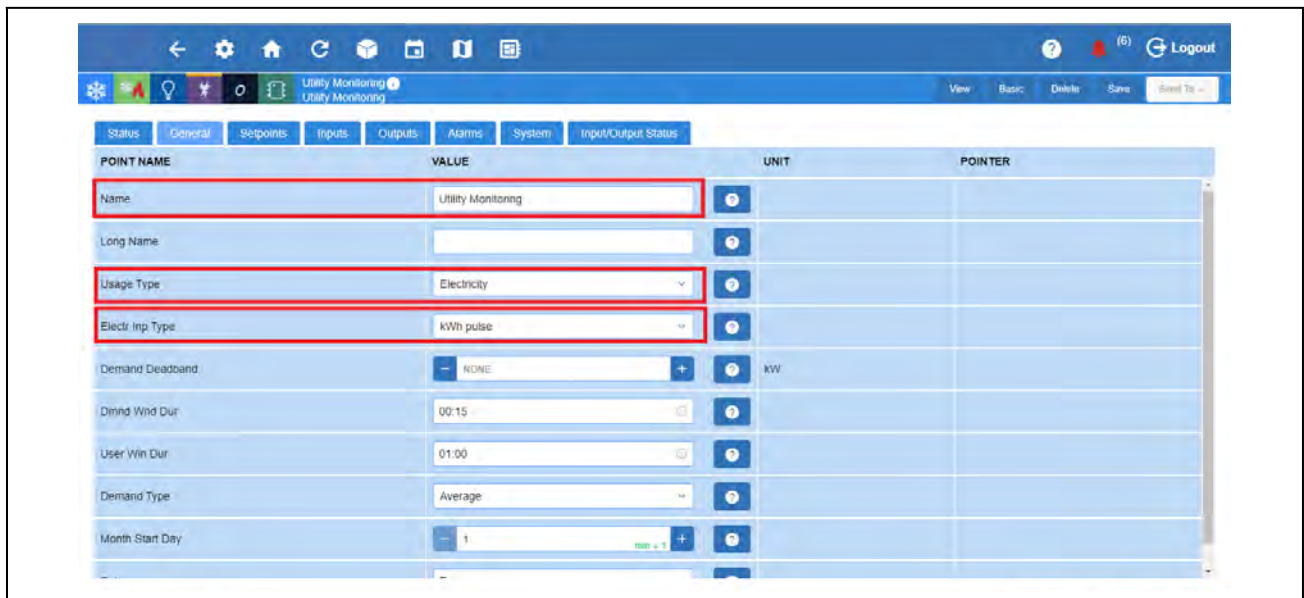

Go to General Tab

- Go to **Inputs** tab and click the right arrow beside it. Under **Target**, select the device where your KWH Pulse is to be found. For this example, select Onboard IO which was configured for pulse earlier. Under **Property**,

select the pointer where the KWH Pulse is connected to and click **Save**.

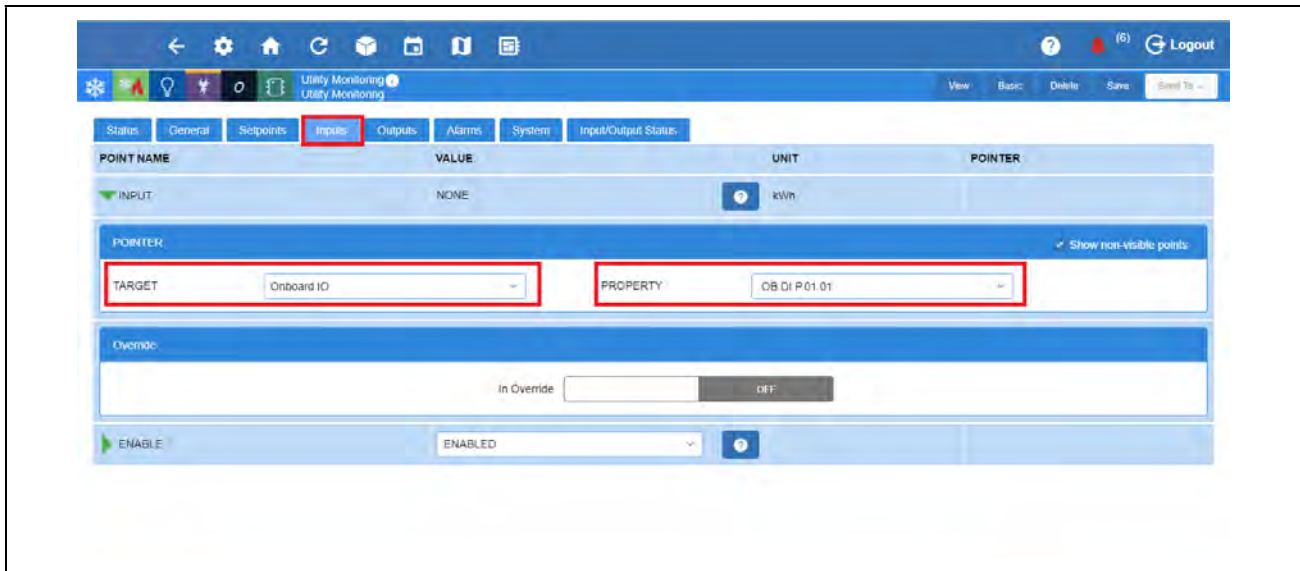

Select Pointer

Note: Only points configured as Pulse Counter will be shown here, so it is important to follow steps shown earlier.

How to Configure an Energy Meter for Power Monitoring

1. From the **Home** screen, go down to **Energy** and select the **Energy Meter** to be configured.

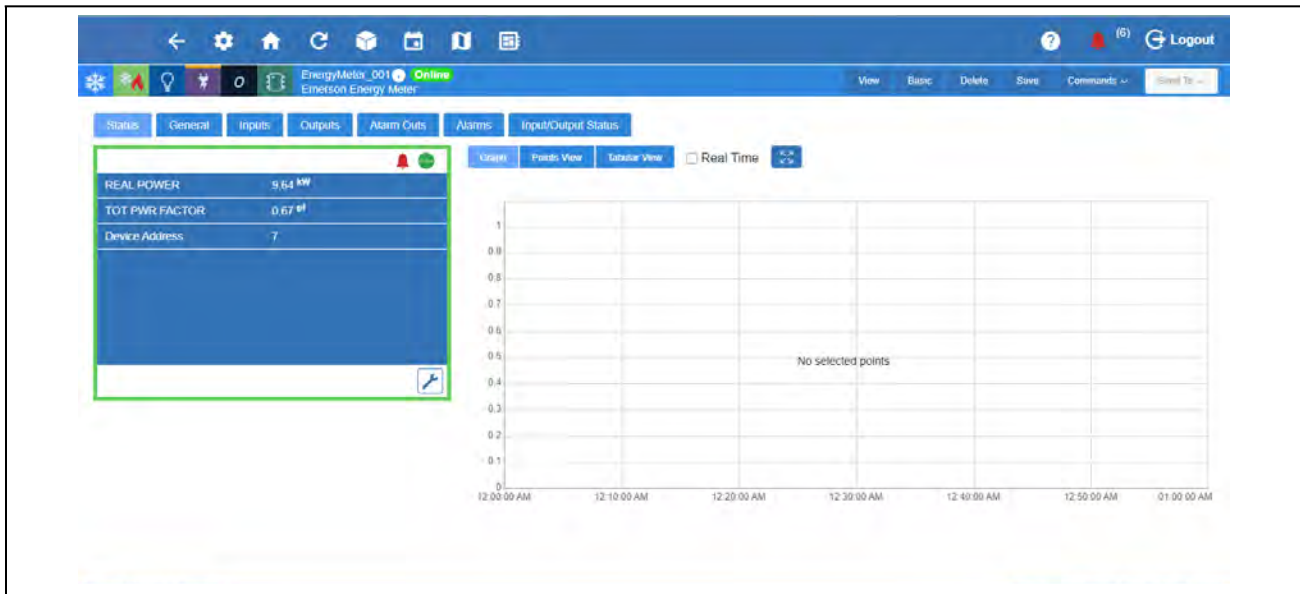

Select Energy Meter

- Go to **General** and enter the **Device Name**.

The screenshot shows the configuration page for 'EnergyMeter_001' in the 'General' tab. The 'Device Name' field is highlighted with a red box and contains the text 'EnergyMeter_001'. Other fields include Long Name, Device Address (7), Route (Modbus-04), CfgSyn Action (Write to Device), Reset Version (2004), OS Version (1041), Serial Number (4DF376D), and System Type (Split Phase: A+B+N).

Enter Device Name

- Setup the **CfgSyn Action**. This displays how to resolve an Out of Sync condition. Select the setting for this parameter using the drop-down list.
 - Read from device** - Data synchronization is from the device to Site Supervisor (the Site Supervisor will read and save configuration data from the device).
 - Write to device data** - Synchronization is from Site Supervisor to device (for example, configuration data programmed in the Site Supervisor will be sent to the device).

The screenshot shows the configuration page for 'EnergyMeter_001' in the 'General' tab. The 'CfgSyn Action' dropdown menu is highlighted with a red box and shows 'Write to Device' selected. Other fields are the same as in the previous screenshot.

Set Up CfgSyn Action

4. Set up the **System Type**. This tells the device which of its current and voltage inputs are valid, which are to be ignored, and if neutral is connected. This sets the type of system which can be one of the following:
- Single Phase: A + N
 - Single Phase: A + B
 - Single Split Phase: A + B + N
 - Phase Delta: A + B + C
 - Phase Y: A + B + B + N

| POINT NAME | VALUE | UNIT | POINTER |
|----------------|-------------------|------|---------|
| Device Name | EnergyMeter_001 | | |
| Long Name | | | |
| Device Address | 7 | | |
| Route | Modbus-04 | | |
| CfgSyn Action | Write to Device | | |
| Reset Version | 2004 | | |
| OS Version | 1041 | | |
| Serial Number | 4DF378D | | |
| System Type | Single Phase: A+N | | |

Set Up System Type

5. Set up the **CTRatio Primary**. The **minimum value** is 5. The **maximum value** is 32000.

| POINT NAME | VALUE | UNIT | POINTER |
|-----------------|-------------------|-------|---------|
| Serial Number | 4DF378D | | |
| System Type | Single Phase: A+N | | |
| CTRatio-Primary | 5 | A | |
| CTRatio-Second | 1 | | |
| PTRatio | 307.10 | | |
| System Voltage | 25174 | volts | |
| Wh Energy Pulse | 1000 | | |
| Num Sub Inrvl | 3 | | |
| Sub Inrvl Len | 00:13.20 | | |

Set Up CTRatio Primary

6. Set up the **CTRatio Second**. The CT Ratio Secondary interface can be 1 or 1/3 V.

The screenshot shows the configuration page for an Emerson Energy Meter. The 'Inputs' tab is selected. The 'CTRatio-Second' field is highlighted with a red box and contains the value '1/3'. Other fields include Serial Number (4DFP378D), System Type (Single Phase: A+N), CTRatio-Primary (5), PTRatio (307.10), System Voltage (2517.4), Wh Energy Pulse (1000), Num Sub Intra (3), and Sub Intra Len (00:13:20).

| POINT NAME | VALUE | UNIT | POINTER |
|-----------------|-------------------|-------|---------|
| Serial Number | 4DFP378D | | |
| System Type | Single Phase: A+N | | |
| CTRatio-Primary | 5 | A | |
| CTRatio-Second | 1/3 | | |
| PTRatio | 307.10 | | |
| System Voltage | 2517.4 | volts | |
| Wh Energy Pulse | 1000 | | |
| Num Sub Intra | 3 | | |
| Sub Intra Len | 00:13:20 | | |

Set Up CTRatio Second

7. Set up the **PTRatio**. The meter scales this value by 100 (example, entering 200 yields a potential transformer ratio of 2:1). The default is 100 (1.00:1), with no PT attached. Set this value before setting the System Voltage.

The screenshot shows the configuration page for an Emerson Energy Meter. The 'Inputs' tab is selected. The 'PTRatio' field is highlighted with a red box and contains the value '2.00'. Other fields include Serial Number (4DFP378D), System Type (Single Phase: A+N), CTRatio-Primary (5), CTRatio-Second (1/3), System Voltage (2517.4), Wh Energy Pulse (1000), Num Sub Intra (3), and Sub Intra Len (00:13:20).

| POINT NAME | VALUE | UNIT | POINTER |
|-----------------|-------------------|-------|---------|
| Serial Number | 4DFP378D | | |
| System Type | Single Phase: A+N | | |
| CTRatio-Primary | 5 | A | |
| CTRatio-Second | 1/3 | | |
| PTRatio | 2.00 | | |
| System Voltage | 2517.4 | volts | |
| Wh Energy Pulse | 1000 | | |
| Num Sub Intra | 3 | | |
| Sub Intra Len | 00:13:20 | | |

Set Up PTRatio

8. Set up the **System Voltage**. The nominal Line to Line Voltage for the system. This is used by the device to calculate the theoretical maximum system power, and as the reference voltage for setting the Phase Loss threshold. **Maximum is 32000 Volts.**

The screenshot shows the 'Input/Output Status' configuration page for an Emerson Energy Meter. The 'System Voltage' field is highlighted with a red box. The value is set to 82, with a maximum of 32000 and a minimum of 80. The unit is 'volts'.

| POINT NAME | VALUE | UNIT | POINTER |
|-----------------|-------------------|-------|---------|
| Serial Number | 4DF376D | | |
| System Type | Single Phase: A+N | | |
| CTRatio-Primary | 5 | A | |
| CTRatio-Second | 1/3 | | |
| PTRatio | 2.00 | | |
| System Voltage | 82 | volts | |
| Wh Energy Pulse | 1000 | | |
| Num Sub Intval | 3 | | |
| Sub Intval Len | 00:13:20 | | |

Set Up System Voltage

Note: The meter device will reject settings that are not within the device's operating range when divided by the PT ratio.

9. Set up the **Wh Energy Pulse**. This is the Wh Energy per Pulse Output Contact Closure. If the meter cannot find a pulse duration that will keep up with the maximum system power, it will reject the new value. In this case, a larger value can be used and select Save.

The screenshot shows the 'Input/Output Status' configuration page for an Emerson Energy Meter. The 'Wh Energy Pulse' field is highlighted with a red box. The value is set to 100. The unit is 'volts'.

| POINT NAME | VALUE | UNIT | POINTER |
|-----------------|-------------------|-------|---------|
| Serial Number | 4DF376D | | |
| System Type | Single Phase: A+N | | |
| CTRatio-Primary | 5 | A | |
| CTRatio-Second | 1/3 | | |
| PTRatio | 2.00 | | |
| System Voltage | 82 | volts | |
| Wh Energy Pulse | 100 | | |
| Num Sub Intval | 3 | | |
| Sub Intval Len | 00:13:20 | | |

Set Up Wh Energy Pulse

How to Create a Utility Monitoring Application

The following procedure shows how to use the Energy Meter's Average Current Output as the Analog Input of the Utility Monitoring Application. The Energy Meter should be setup first before configuring the Utility Monitoring Application.

1. From the **Home** screen, go down to **Energy** and select the **Energy Meter** to be configured.

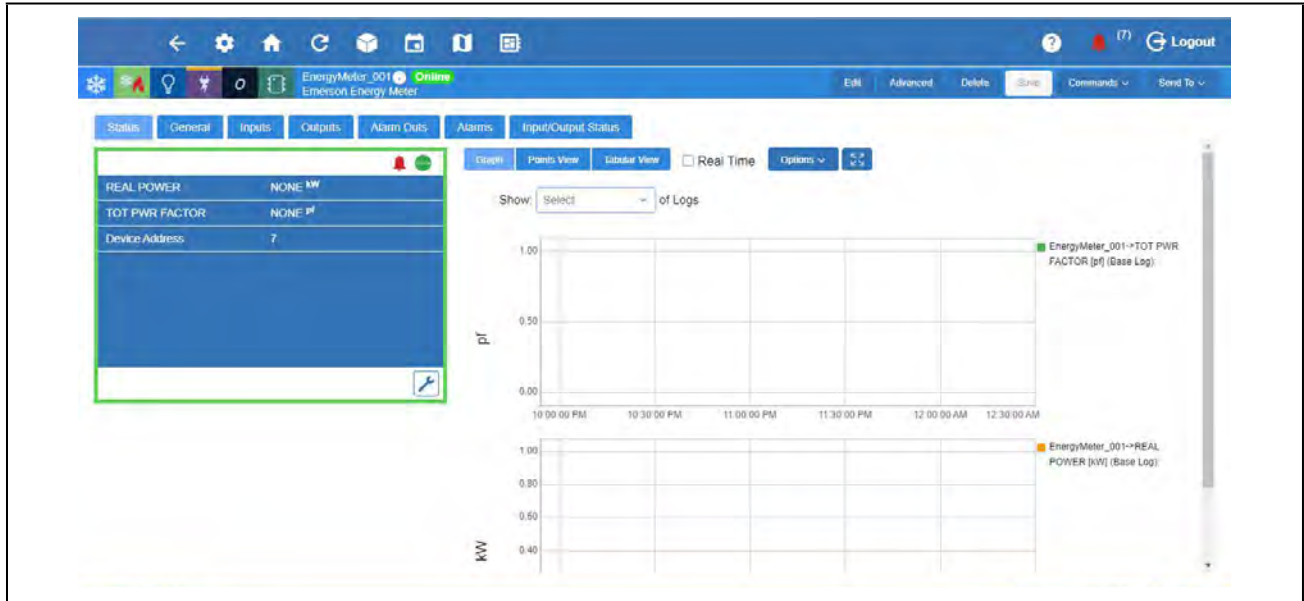

Set Up PTRatio

2. Go to **Outputs** tab and locate **Current A, Current B and Current C**.

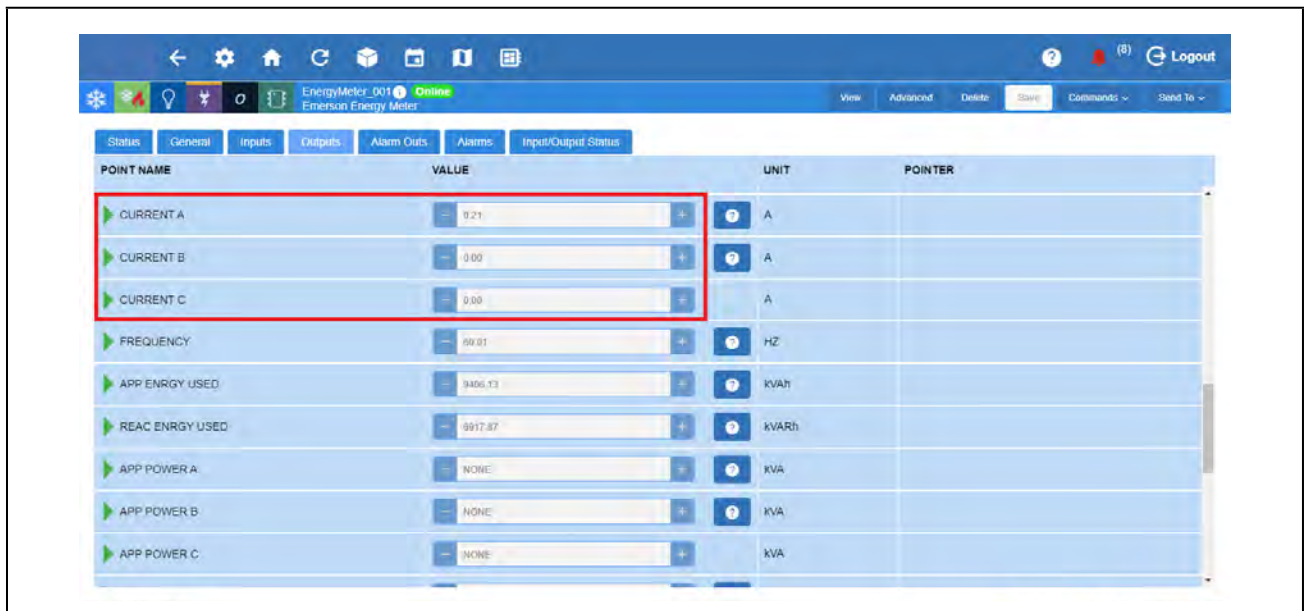

Set Up PTRatio

- Click the right arrow beside Current A. Under Target, select Utility Monitoring. Under Property, select Input. Do the same for Current B and C, Inputs 2 and 3 and select Save.

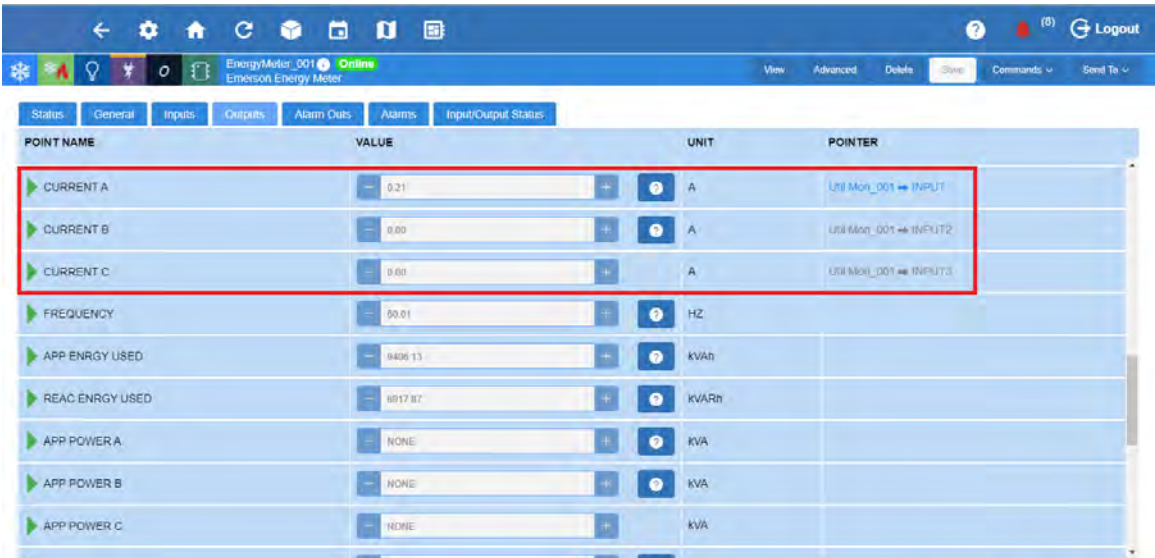

The screenshot displays the 'Input/Output Status' tab of the Supervisory Control Platform. The interface shows a table of points with columns for 'POINT NAME', 'VALUE', 'UNIT', and 'POINTER'. A red box highlights the first three rows, which are 'CURRENT A', 'CURRENT B', and 'CURRENT C'. The 'POINT NAME' column shows 'CURRENT A', 'CURRENT B', and 'CURRENT C'. The 'VALUE' column shows '0.21', '0.00', and '0.00'. The 'UNIT' column shows 'A', 'A', and 'A'. The 'POINTER' column shows 'Uni Mon_001 -> INPUT1', 'Uni Mon_001 -> INPUT2', and 'Uni Mon_001 -> INPUT3'. The interface also includes a navigation bar at the top with icons for home, refresh, and other functions, and a status bar at the bottom with 'View', 'Advanced', 'Delete', 'Save', 'Commands', and 'Send To' options.

| POINT NAME | VALUE | UNIT | POINTER |
|-----------------|---------|-------|-----------------------|
| CURRENT A | 0.21 | A | Uni Mon_001 -> INPUT1 |
| CURRENT B | 0.00 | A | Uni Mon_001 -> INPUT2 |
| CURRENT C | 0.00 | A | Uni Mon_001 -> INPUT3 |
| FREQUENCY | 50.01 | HZ | |
| APP ENRGY USED | 9406.13 | KVAh | |
| REAC ENRGY USED | 8917.87 | KVARh | |
| APP POWER A | NONE | KVA | |
| APP POWER B | NONE | KVA | |
| APP POWER C | NONE | KVA | |

Select Input

Appendix E: Peer to Peer Network Setup for Mixed Sites (Two Supervisors and One E2)

A Peer network allows communication between multiple controllers to take place with one controller as the annunciator, which will send alarms for all the controllers on the network.

Supervisory Controller Peer Network Setup

Step 1: Open a Browser

To begin setting up the controllers for a Peer Network, open a browser and enter the IP address of the Supervisory Controller you wish to add to your Peer Network. You will repeat this process for each controller you are setting up on your Peer Network.

Step 2: Click the Gear Icon

For each Supervisory Controller, click the gear  and go to **Configure System > General System Properties > System Values**. The System Values page is where you will set up the parameters for each controller on the Peer Network.

Step 3: Assign Unique Numbers and Names

When setting up a Peer Network, remember that each controller must have unique unit numbers and unique unit names. These controller setup parameters are located on the **System Values** page under **UnitNumber and Unit Name**. For each controller you are adding to your Peer Network, enter a unique unit name and then a unique unit number.

1. Enter a unique name in the **Unit Name** field.
2. Assign a unique number in the **UnitNumber** field.
3. Enter a Group Name for your Peer Network and keep that name *identical* across all the controllers on your Peer Network.

Helpful Hints

It is also recommended that the default name for the controllers (Unit Name) be changed to include the unique Unit Number you assign, so it is easier to tell the controllers apart. For example, if the unique Unit Number you assign to the Supervisory Controller is 4, update its Unit Name to SS Unit04. When you view the Alarms page, you can quickly and easily differentiate the Supervisory Controllers and E2 controllers. For E2 controllers, consider using a name that contains "E2" in the name. The **Device Type** column will show SS or E2.

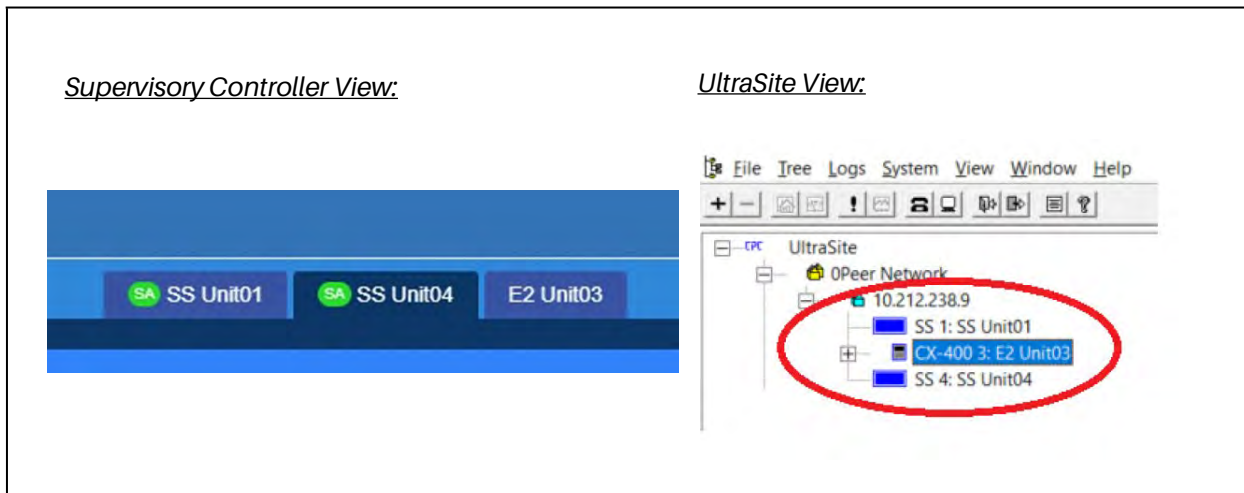

Network Settings

E2 Peer Network Setup Using UltraSite or Terminal Mode

UltraSite Setup

1. For E2 setup, open UltraSite and connect to the E2 controller you wish to add to the Peer Network.
2. Once connected to the E2 controller, right-click **Device Setup > General Setup:**

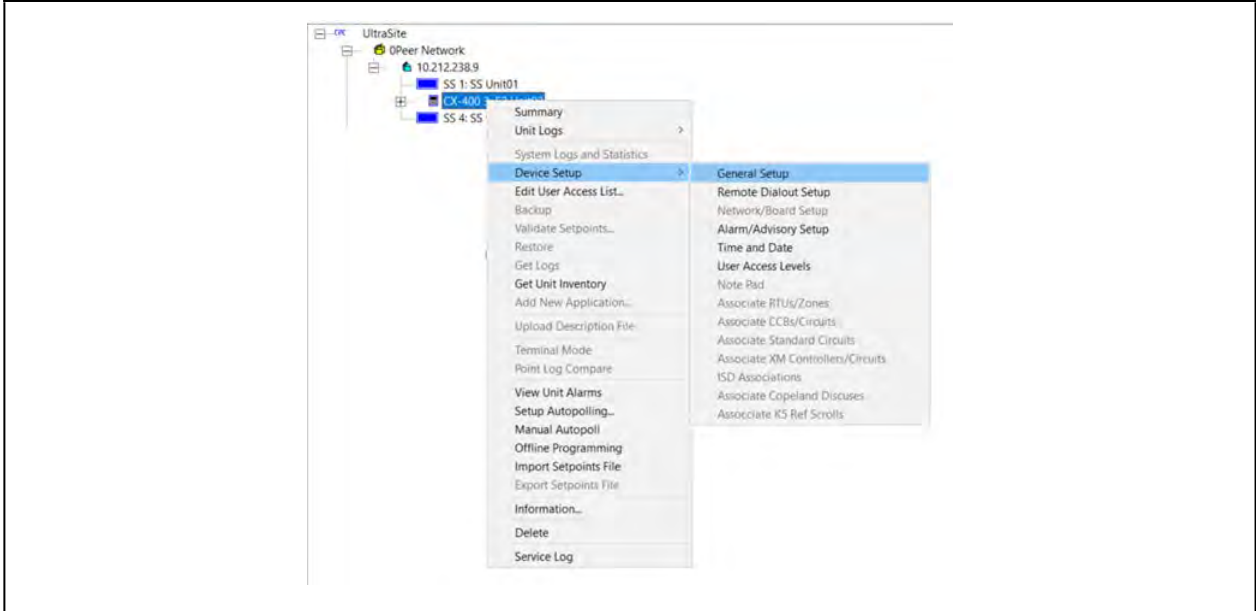

General Setup

3. Click the **Peer Network** tab and enter the **Group Name** that is the same across all the other controllers on the Peer Network:

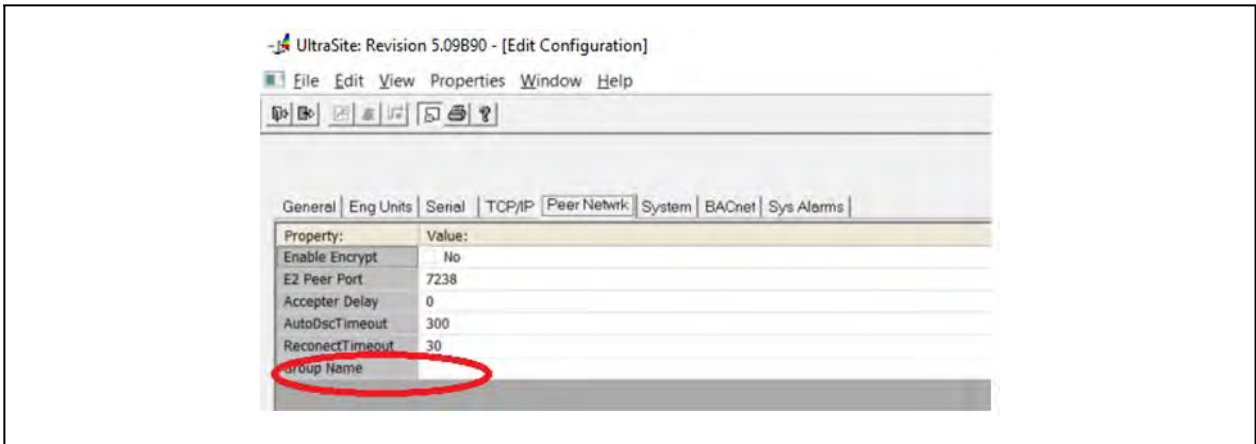

Group Name

E2 Peer Setup using Terminal Mode

To set up the Peer Network from the E2, right-click the desired E2 and open **Terminal Mode**:

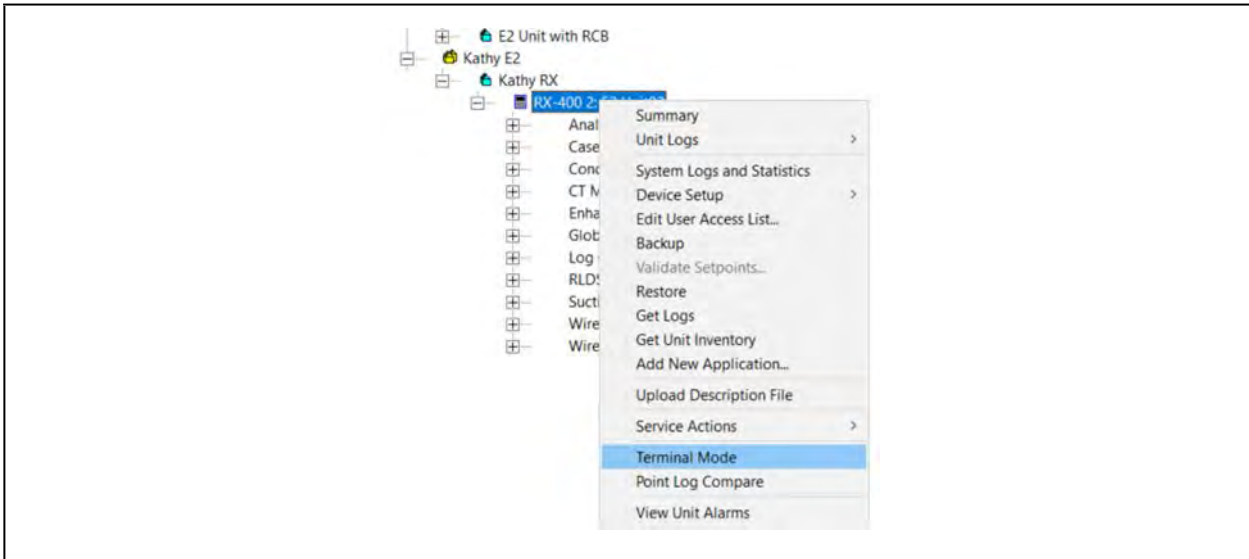

Terminal Mode

Log into the E2 and follow these steps to add your E2 to the Peer Network:

1.  and choose  - **System Configuration**:

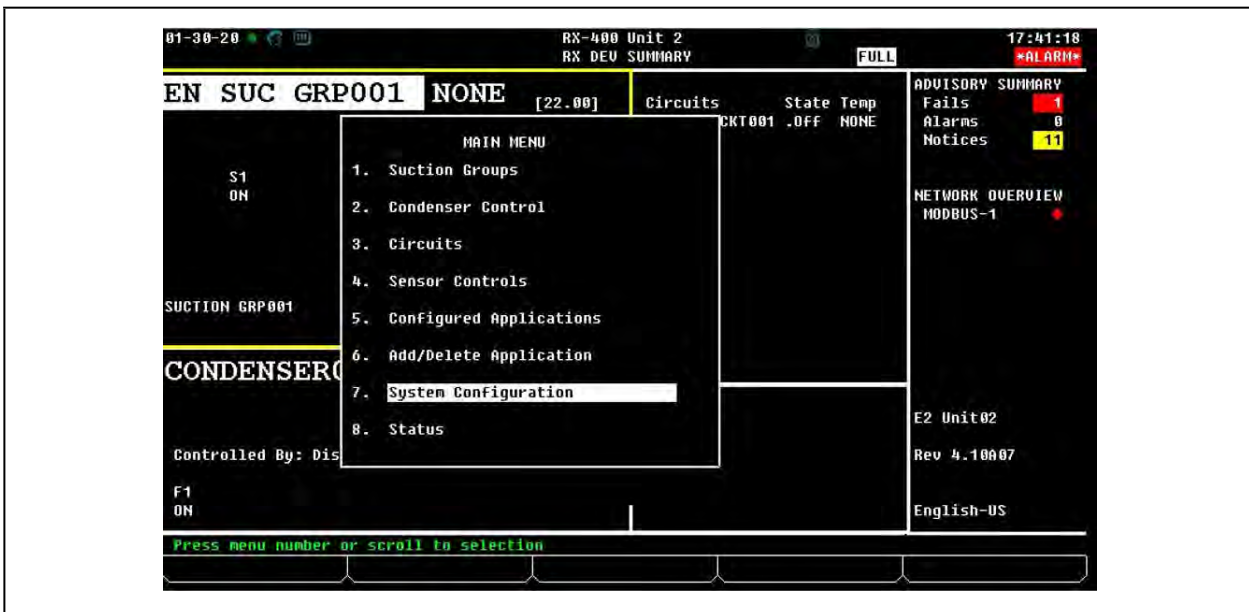

System Configuration

2. Select **3** - System Information:

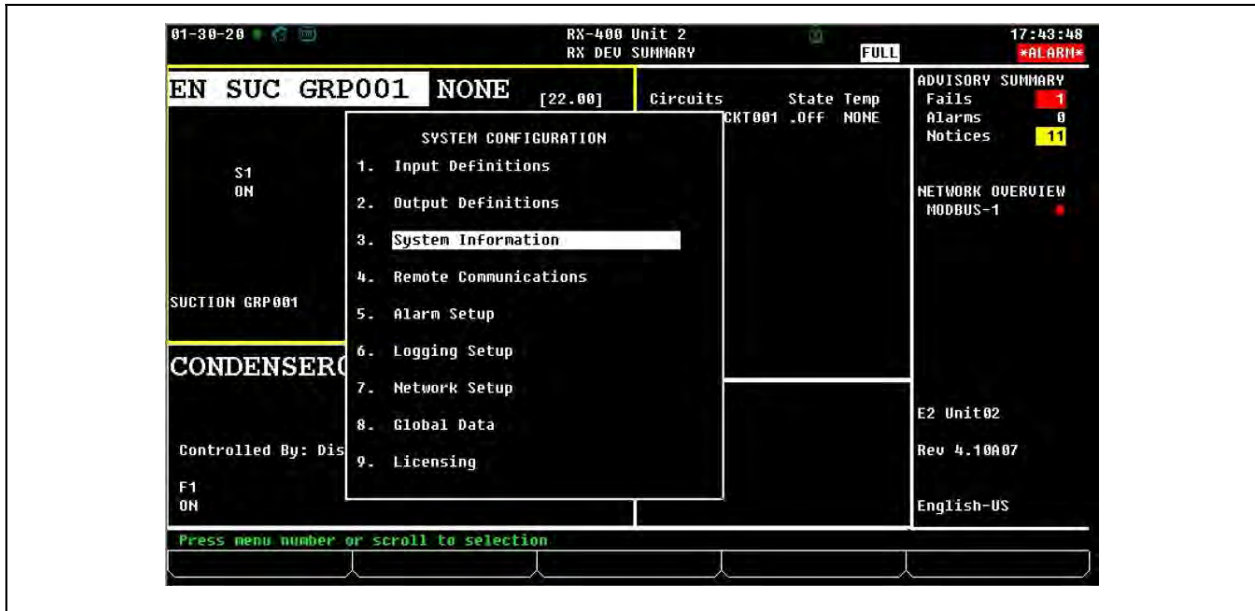

System Information

3. Select **1** - General Controller Information:

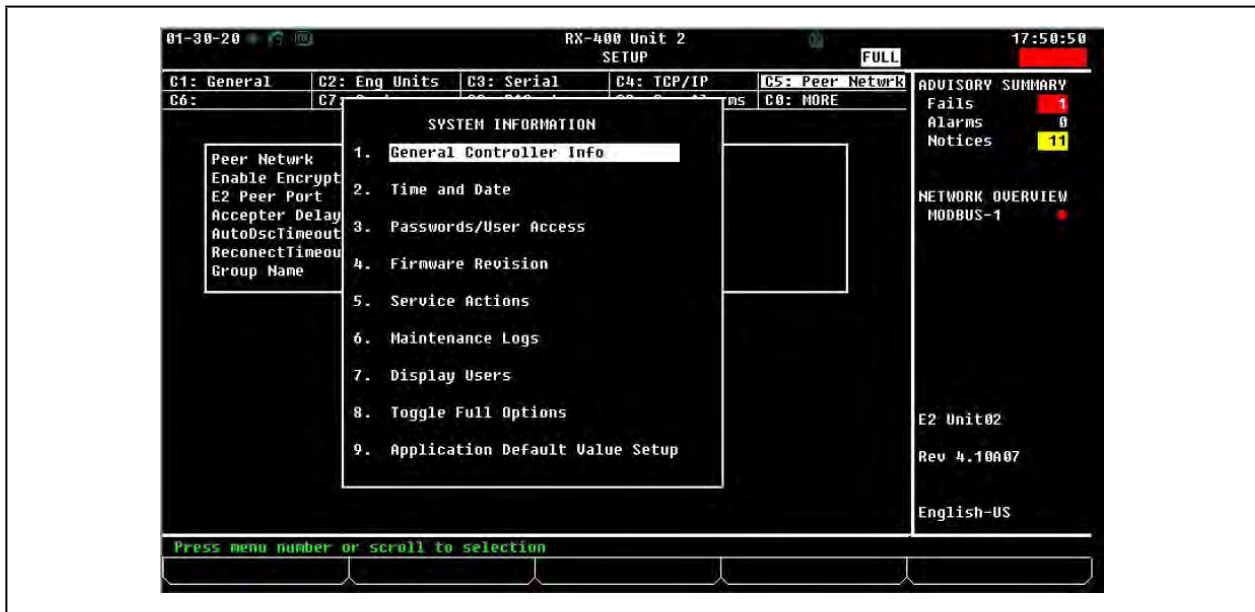

General Controller Info

4. Tab over to the **Peer Network** tab and enter the **Group Name**:

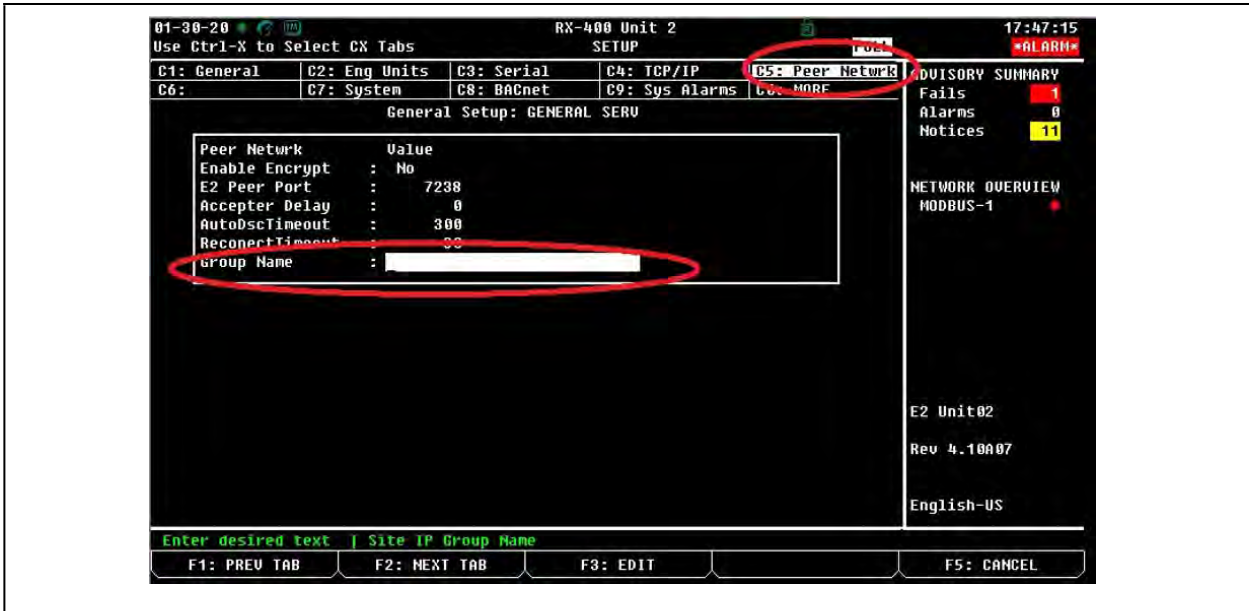

Enter Group Name

5. Next, go to **Network Summary**:  and choose **7** - **System Configuration**:

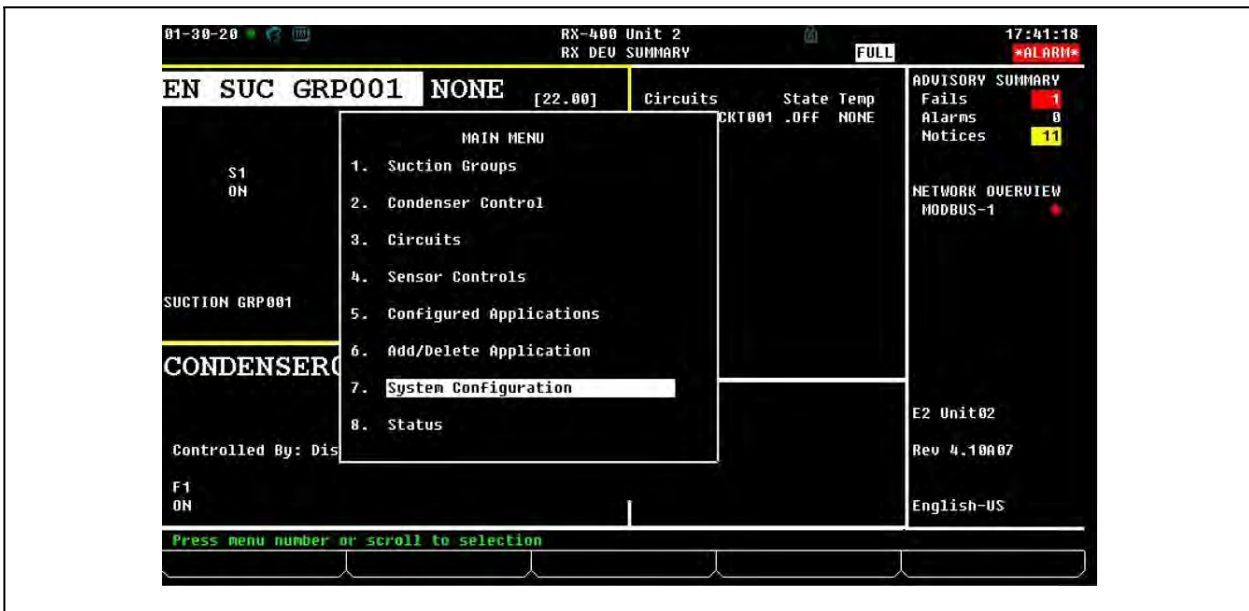

System Configuration

6. Select **7** - Network Setup:

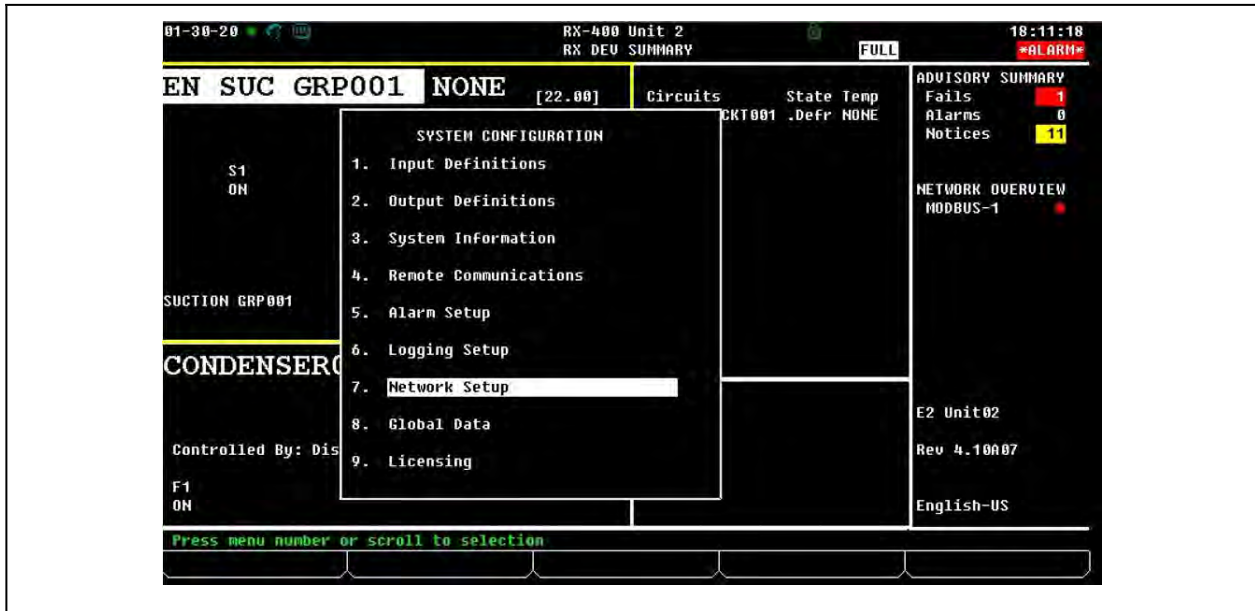

Network Setup

7. Select **1** - Network Summary:



Network Summary

8. From the **Network Summary** screen, check the online status of the other controllers:

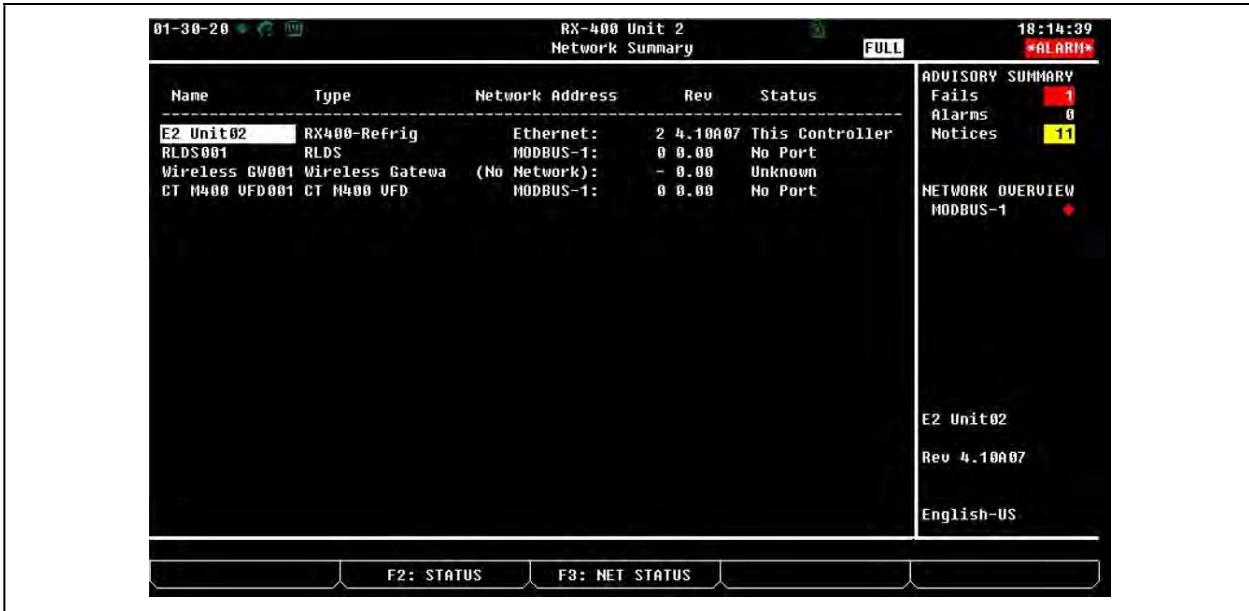

Check Online Status

9. Next, access the Unit # by  and choose **1** - System Configuration:

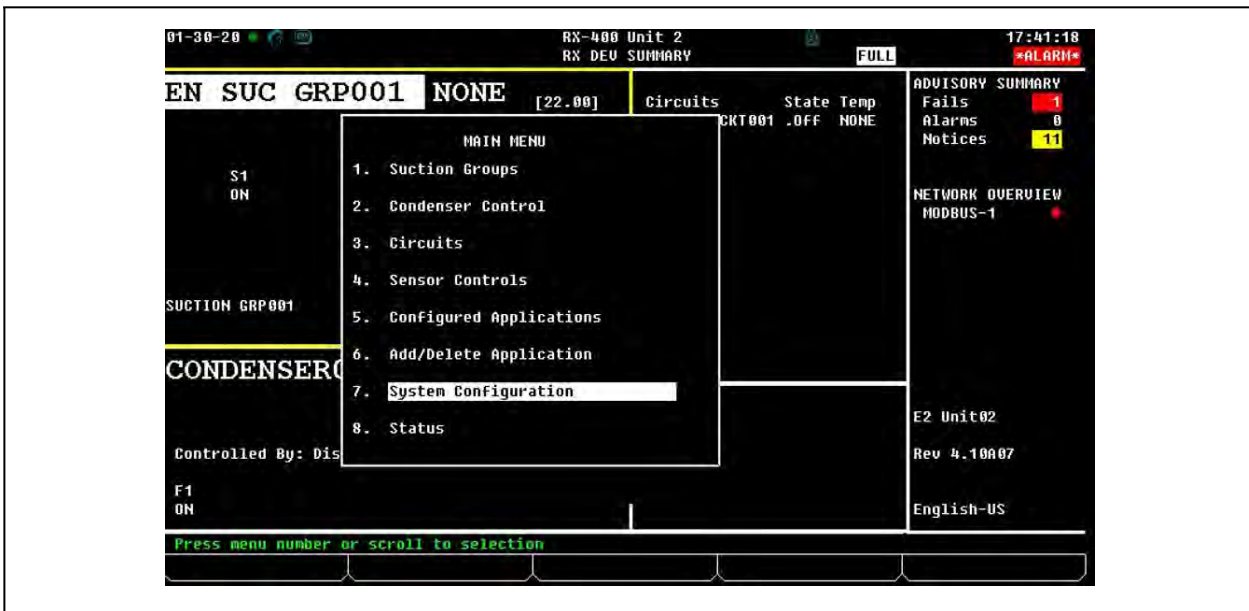

System Configuration

10. Select **7** - Network Setup:

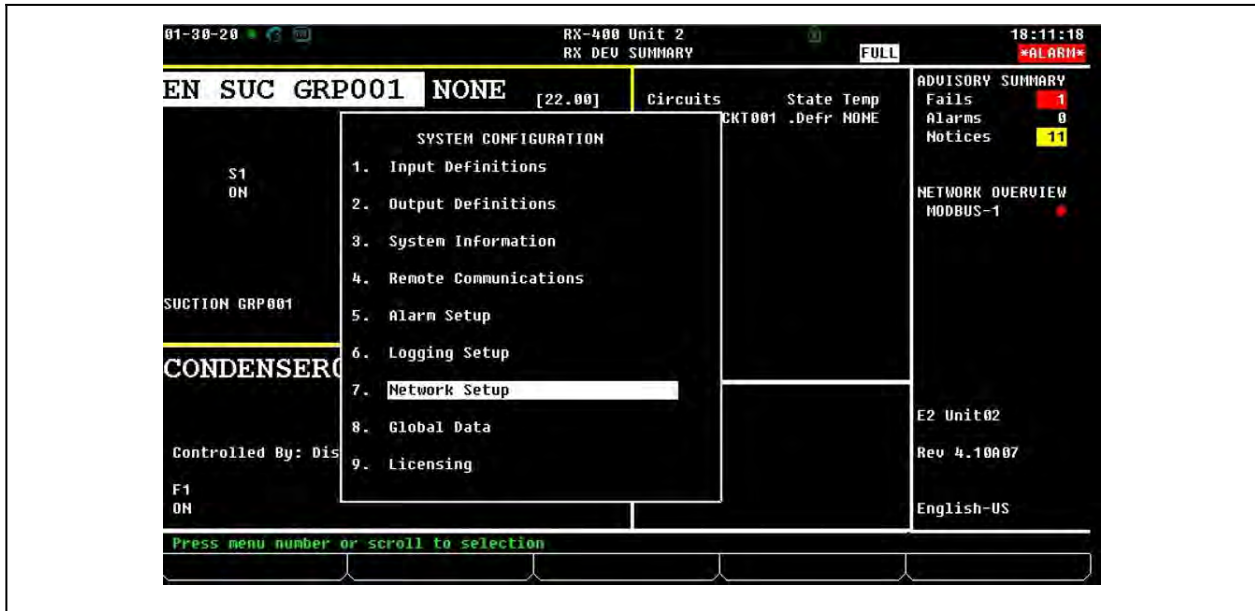

Network Setup

11. Select **2** - Connected Boards & Controllers and go to This Unit tab:

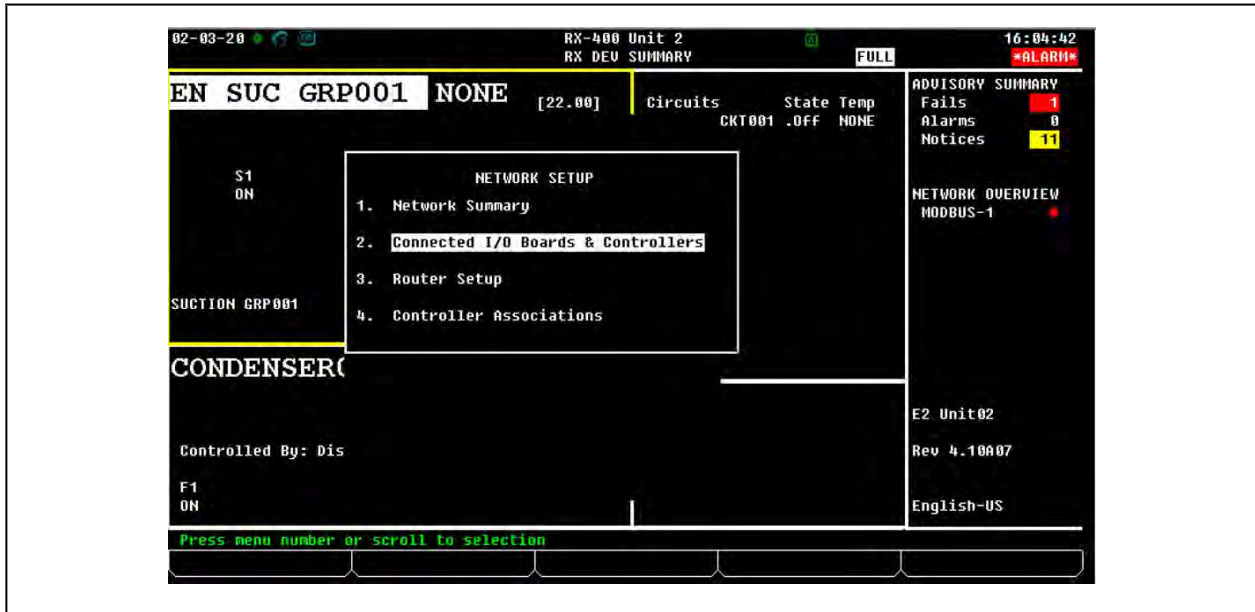

Connected I/O Boards & Controllers

12. Check the **Unit Name** and **Unit Number** to verify they are unique and set up correctly:

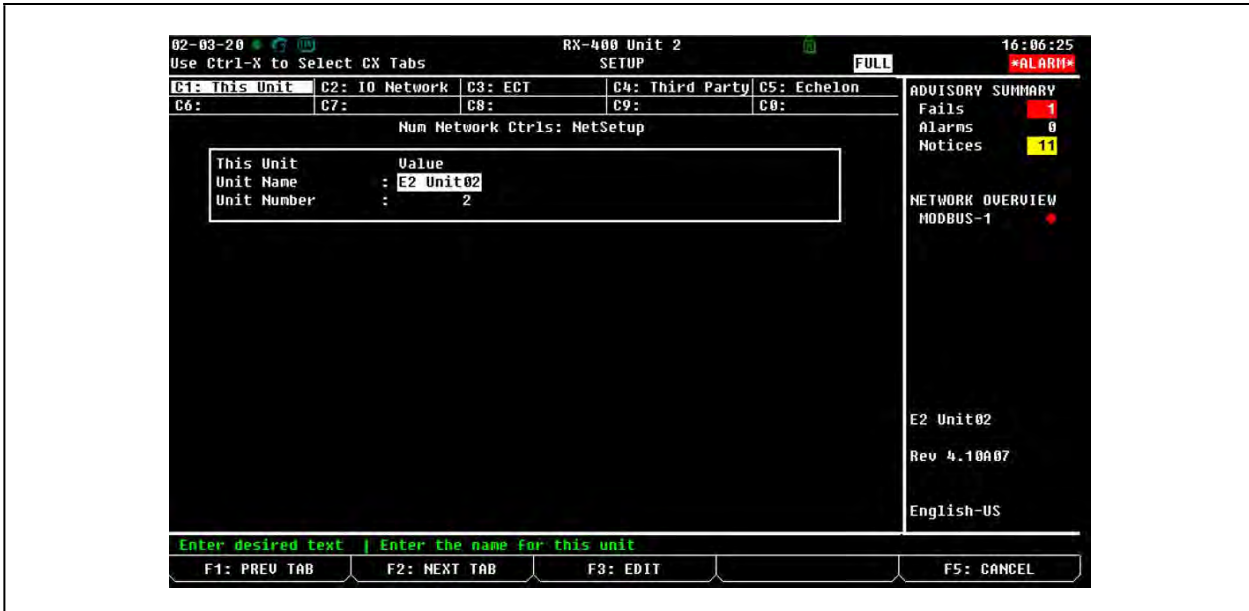

Connected I/O Boards & Controllers

13. To populate all controllers on the Peer Network in UltraSite, right-click the controller at the Site level and click **Disconnect**. Then re-connect to the Site by clicking **Connect**.

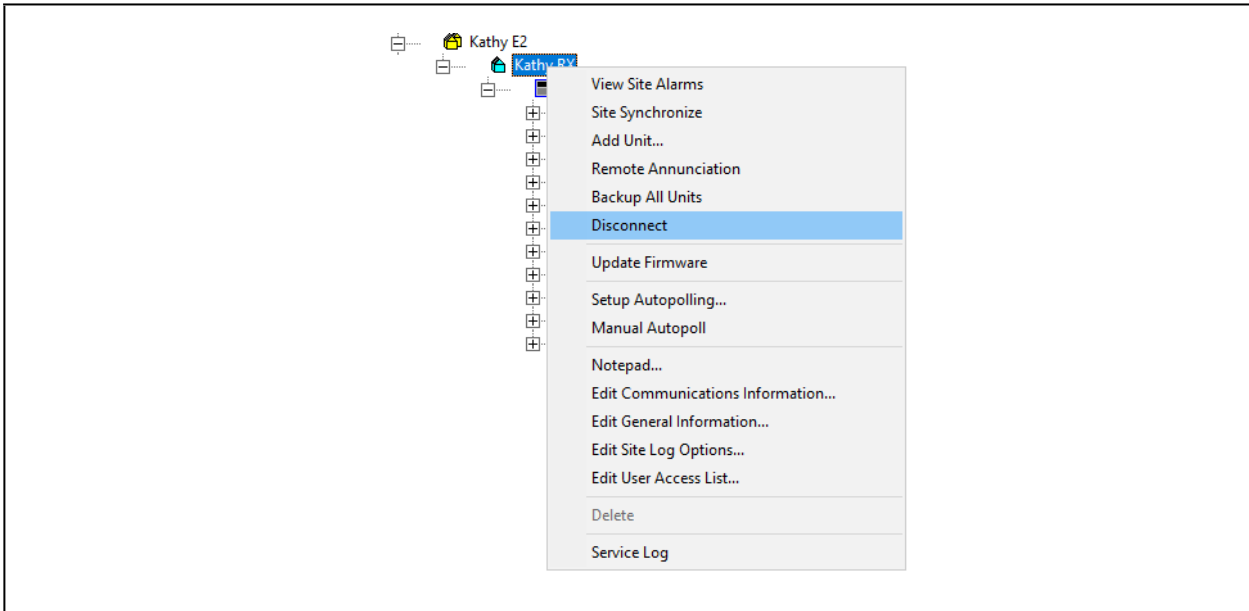

Click Disconnect

Re-connect

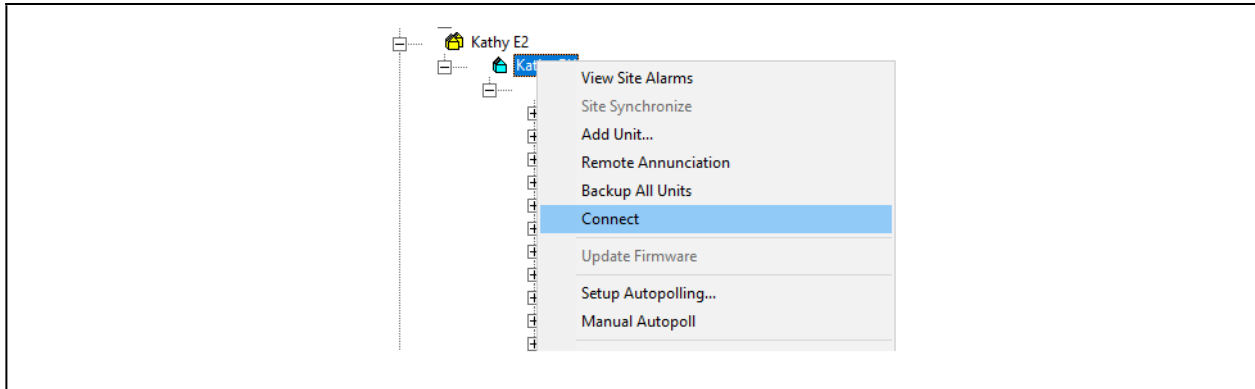

Click Connect

A Controller Reset May Be Required

Once all the controllers have been added, a reset for each controller may be required before they are visible on the controller set up as the Annunciator.

Set Up the Annunciator

Once you have set up the controllers, decide which controller will be the Annunciator.

Note that when you click each tab, you will log into each controller. You are automatically logged off each controller as you move from tab to tab.

Once the Peer Network is set up, only 1 browser is needed to switch between controllers. (Chrome is recommended).

To see the alarms for all controllers on the network, click the **Alarm**  bell and the Active Alarms screen will open. From this screen you can view all alarms across the Peer Network.

Refer to the Unit Number and Unit Name columns to locate alarms for the controllers:

| Description | Type | Time Occurred | Age | Unit Number | Unit Name | Device Type | Status | Originator | Device/App |
|--------------------------------|----------|---------------------|------------|-------------|-----------|-------------|--------|-----------------------|--------------|
| Network Device Offline | Critical | 24/01/2020 20:58:56 | ---- | 1 | SS Unit01 | SS | UNACK | XR75CX_26_001 | XR75CX 2.6 |
| Network Device Offline | Critical | 24/01/2020 20:54:04 | 0h 0m | 1 | SS Unit01 | SS | UNACK | XM679K_34_001 | XM679K 3.4 |
| Application config has changed | Notice | 24/01/2020 14:50:36 | 5h 4m | 3 | E2 Unit03 | E2 | UNACK | GENERAL SERV | E2 |
| Network Device Offline | Critical | 06/01/2020 13:31:15 | 18d 7h 23m | 4 | SS Unit04 | SS | UNACK | TouchT-Stat_001 | Touch T-Stat |
| Network Device Offline | Critical | 10/12/2019 18:53:29 | 45d 2h 1m | 4 | SS Unit04 | SS | UNACK | WIC_Sys_A_Evap_2_(05) | XR75CX 5.6 |
| Network Device Offline | Critical | 10/12/2019 18:53:21 | 45d 2h 1m | 4 | SS Unit04 | SS | UNACK | WIF_Sys_B | XR75CX 2.6 |
| Network Device Offline | Critical | 10/12/2019 18:53:21 | 45d 2h 1m | 4 | SS Unit04 | SS | UNACK | WIF_Sys_A | XR75CX 2.6 |
| Network Device Offline | Critical | 10/12/2019 18:53:20 | 45d 2h 1m | 4 | SS Unit04 | SS | UNACK | WIC_Sys_B_Evap_2_(06) | XR75CX 2.6 |
| Network Device Offline | Critical | 10/12/2019 18:53:19 | 45d 2h 1m | 4 | SS Unit04 | SS | UNACK | WIC_Sys_B_Evap_1_(04) | XR75CX 2.6 |
| Network Device Offline | Critical | 10/12/2019 18:53:19 | 45d 2h 1m | 4 | SS Unit04 | SS | UNACK | WIC_Sys_A_Evap_1_(03) | XR75CX 2.6 |

Active Alarms Screen

Appendix F: Using the E2 setpoint conversion tool when retrofitting E2 with supervisory or E3 controllers: Using the Latest Version of UltraSite32™

Note:

- Conversion of E2 setpoints should be done using a .003 setpoint file extension.
- 3rd party integrations are not supported by this conversion process.

When retrofitting E2 with supervisory controllers, a backup/restore process should be performed on the E2 controller. The supervisory controller will run the same devices and applications as the E2, but instead of manually entering the information, the setpoints and configurations can be automatically converted from the E2 to the supervisory controller using the latest version of UltraSite. The conversion tool can be expected to convert 80% or more of your E2 backup file. The conversion process will take between 10 to 20 minutes depending on the complexity of the backup file. You must do a side-by-side comparison of the E2 backup file and the newly converted Supervisor file to verify there are no errors. It will be necessary to review all setpoints and alarms for consistency in addition to the error log report and restore comparison log (see **Site Supervisor Restore Error List**) that is generated at the end of the conversion process to ensure your new system will run properly. Licensed features will not convert if your new controller does not have the licenses or features installed. Note that some complex schedules and Flex Combiners may not be converted.

For any firmware version below 3.05F05, it is recommended to upgrade in the order listed below to at least 3.08F03, then do a back-up (.003) to restore to the Site Supervisor or E3.

| | |
|-------------------------|-----------------|
| 1 st upgrade | 3.05F05 |
| 2 nd upgrade | 3.08F03 |
| 3 rd upgrade | 3.09F04 |
| 4 th upgrade | Current release |

Step 1: Set Up Supervisor in UltraSite

1. Log into UltraSite as **user/pass**.
2. Add **Supervisor** as a Site (right-click **Directory** and click **Add Site**).

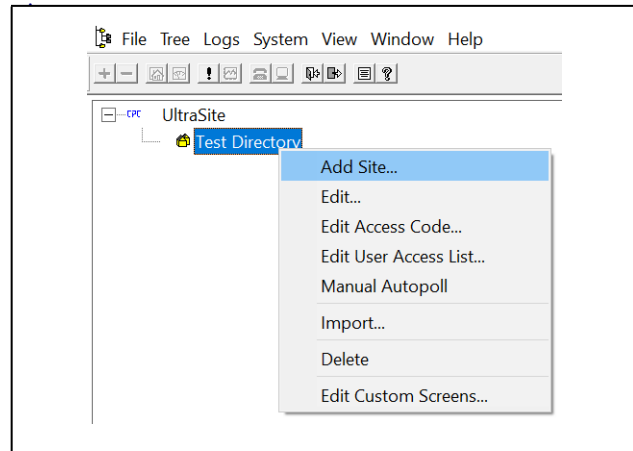

Click Add Site

3. The **Add Site** window displays:

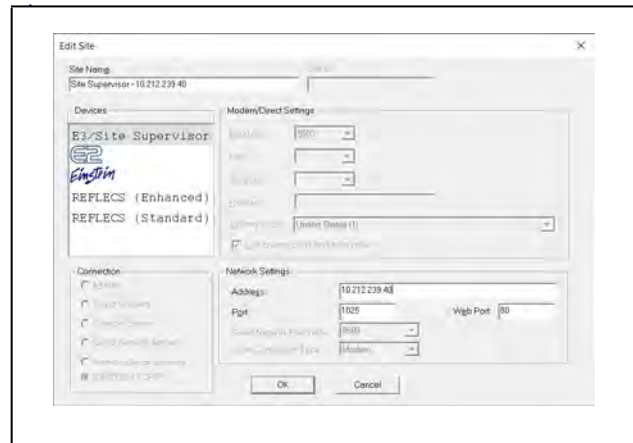

Site Configurations

4. Enter a **Site Name**.
5. Enter the **Site Supervisor IP Address** in the address field under **Network Settings**.
6. Select the Supervisor controller under **Devices**. Confirm Site Supervisor is highlighted under Devices, if it is not highlighted, select **Site Supervisor**.

7. Confirm **EINSTEIN TCP/IP** is auto-selected under **Connection** and confirm that Port and Web Port are correct (these values should match your Site Supervisor).
8. Click **OK**.
9. Confirm the **Site Name** is listed under the **Directory** in the tree:

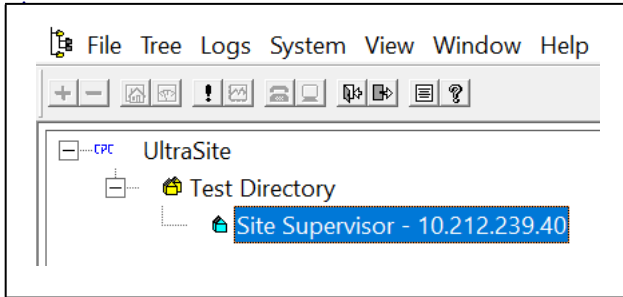

Verify the Site Name is Located Under the Appropriate Directory

10. Right-click the **Supervisor** and click **Edit User Access List**:

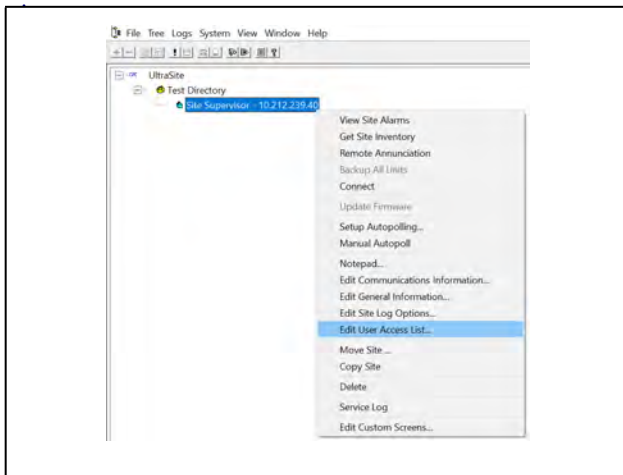

Right-click the Supervisor to access the Edit User Access List

11. From the **Edit User Access List** window, click **Add**:

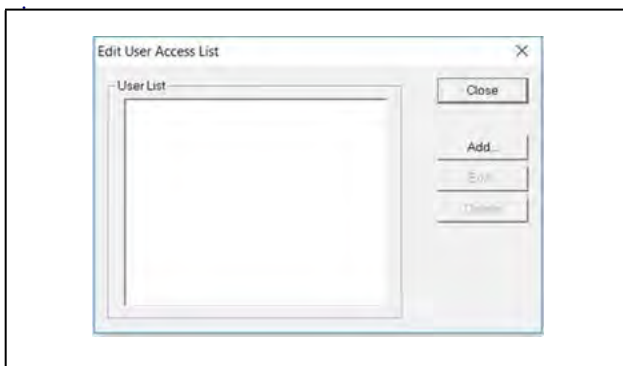

Click Add

12. The **Add User Info** window opens:

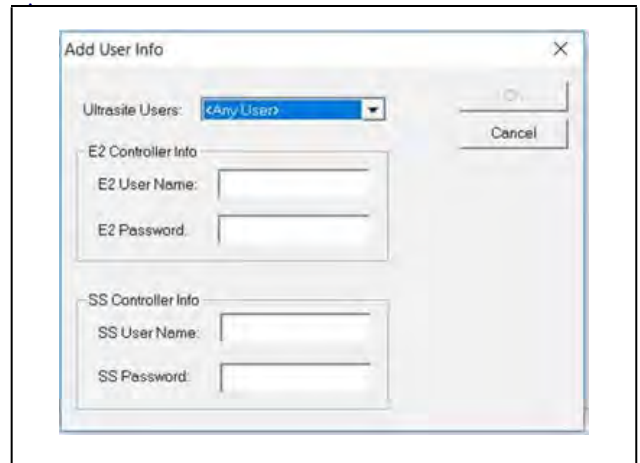

Add User Info

13. Select your UltraSite user name from the **UltraSite Users** drop-down list or leave it as **Any User**.
14. Enter the **username** and **password** for E2 (The OK button will not enable without also entering a user name/password for E2. Note that user/pass can be entered).
15. Enter the user name and password for the Supervisor you are restoring to.
16. Click **OK**.

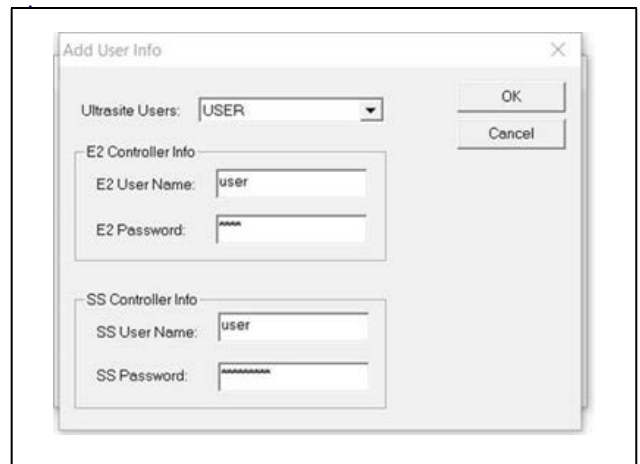

Click OK

17. The **Edit User Access** window displays - click **Close**.

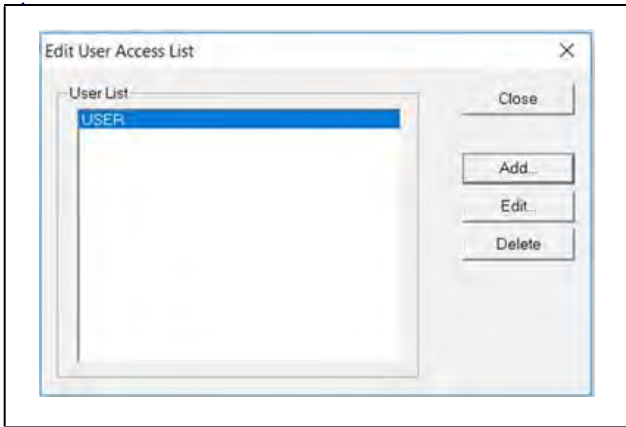

Click Close

18. Right-click the Supervisor site name and click **Connect** to connect to the Supervisor.

Note that the Site Synchronization window will briefly display while connecting to Supervisor.

19. The Supervisor Unit Name will be listed under the Site:

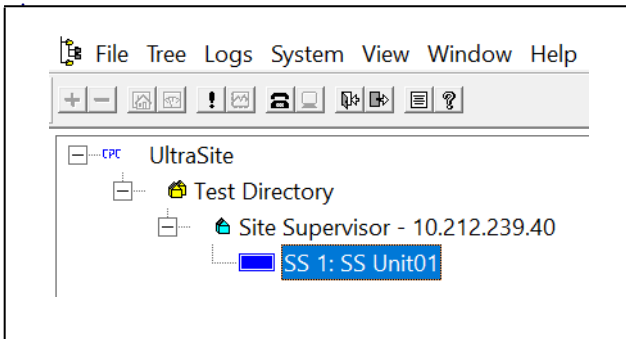

Supervisor Unit Located Under the Site

Step 2: Run UltraSite to Supervisor Restore Process

1. Right-click the Supervisor and select **Restore** (the Restore option is only enabled after connection and site synchronization to the Supervisor has occurred):



Right-Click and Select Restore

2. The following message will display:

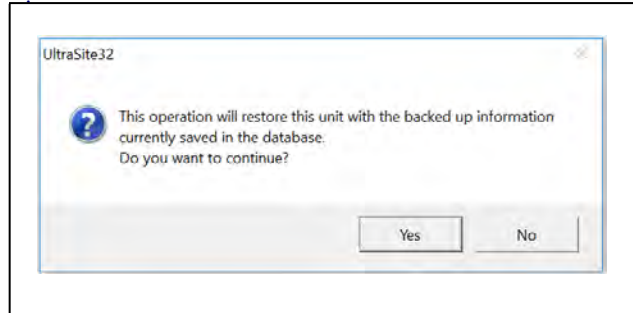

Restore Process

3. Click **Yes**.

4. A browser window will display.

5. Select the setpoint file you wish to restore and click **Open**.

- A status bar of the restore process will display (wait time is dependent on the file size).

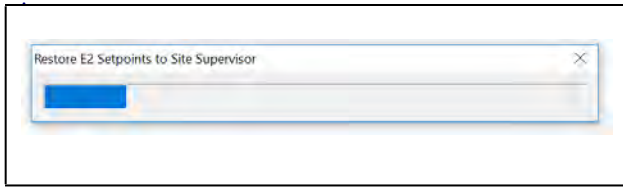

Restore Process Status Bar

- When completed, a Site Supervisor Restore Error List (**Site Supervisor Restore Error List**) will display and contain a Summary Error List of any of the following:
 - Unsupported or applications that cannot be converted.
 - Invalid properties.
 - Mismatched properties, points, parameters, and more.
 - Applications that encountered issues during the restore.



Site Supervisor Restore Error List

- Click **Save** Error List to save the Summary Error List in a .csv file.
- Click **Show Value Differences** to show an html view of the **Summary Error List**.
- Click **Show Restore Comparison** to open a .csv file of all the points sent by the E2 with a side-by-side comparison of the Supervisor values. This file can be saved or closed.

- Click **Close** or the **X** at the top right to close the **Site Supervisor Restore Error List** window.

- The following message will display:

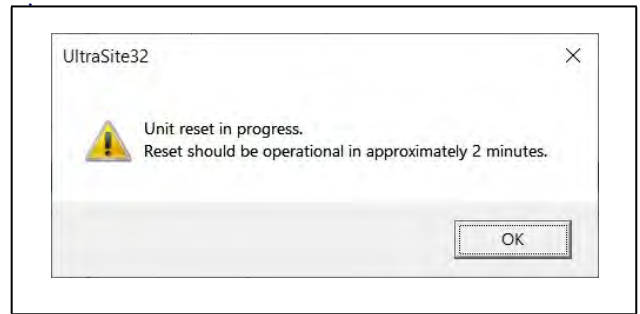

Site Supervisor Restore Error List

- Click **OK** to start the Supervisor reboot process and confirm the Site Supervisor has rebooted successfully.

Step 3: Restore Errors Listed on the Site Supervisor Restore Error List

- In UltraSite, connect to the E2 with the setpoints that were restored to the Supervisor.
- For each application/device listed in the **Site Supervisor Restore Error List**, right-click and select Edit Application.
- For each error, compare the properties and their values to the same application/device in the Supervisor tab point names and values (for Site Supervisor, always click **Advance**).
- Change or add the Supervisor's value, setpoints, devices, applications, parameters to match the E2.

Appendix G: Firmware Update

When a USB device containing Supervisory Controller firmware package is plugged into the Supervisory Controller device, the system will automatically detect it. Once the user reaches the firmware updating page, the firmware from USB disk option can be selected. The firmware updating process includes three steps:

- **Select:** Select a firmware package from the USB and conduct a legitimacy check.
- **Transfer:** Transfer the selected firmware from the USB to the Supervisory Controller.
- **Apply:** Upgrade the transferred firmware to the targeted Supervisory Controller.

A processing bar will appear to inform the user of the real-time processing during transferring and application. The system will reboot automatically when the application process is complete.

Firmware Update - Remote Access

1. Download the latest firmware update file (for example, "SS_2.0XF01_Firmware_Update") to a location on your PC.
2. Connect a standard Ethernet cable from the Supervisory Controller (ETH 0 port) to a router and enter the Supervisory Controller IP address into a browser.
3. Login and select **Configure System > File Management & Licensing** from the Main menu .
4. Before proceeding with the firmware update, click **Backup** (to back up configuration files).
5. Once the backup is complete, click **Upgrade Firmware** and click **Select**. Browse and locate the latest firmware update file. Select the file and click **Open** or double-click the file to load.
6. A Loading file message will appear (wait for several seconds). Once loaded, the **Revision** and **File Size** will display.
7. Click **Transfer**. A progress bar will appear with the percentage complete.

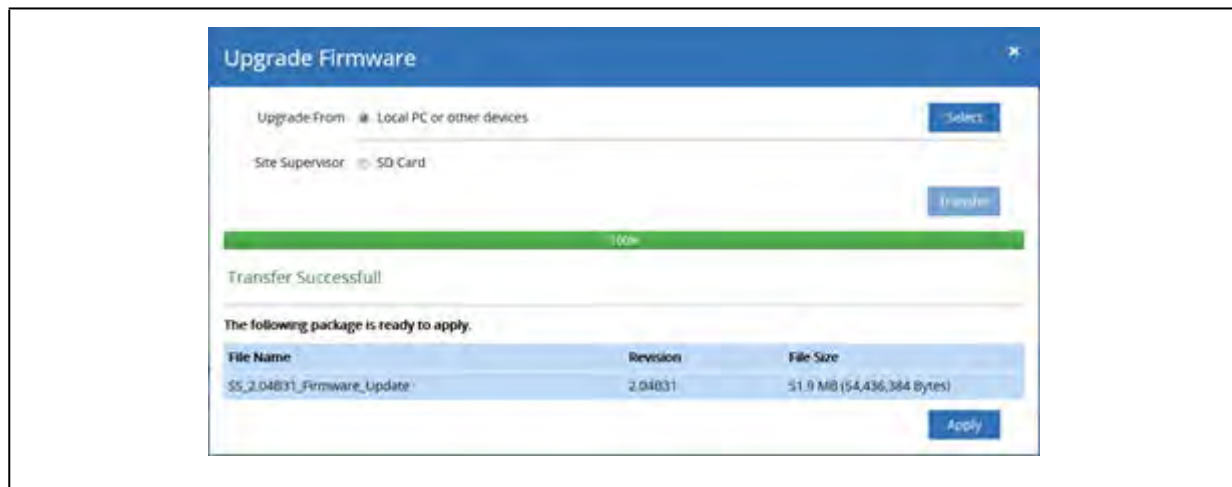

Upgrade Firmware - Remote Access

8. Click **Apply**. A progress bar will appear with the percentage complete. The system will reboot and restart automatically when the upgrade is complete.
9. The new firmware version number will appear in the lower right corner of the screen.

Note that all setpoints and configuration will remain the same. If there are discrepancies, use the backup file to restore previous settings.

Firmware Update - USB Drive

1. Copy the latest firmware update file (for example, "SS_2.02F08_Firmware_Update") to the root folder of a USB thumb drive (the USB thumb drive must be format FAT16).
2. Connect a standard Ethernet cable from the Supervisory Controller (ETH 0 port) to a router and enter the Supervisory Controller IP address into a browser.
3. Login and select **Configure System > File Management & Licensing** from the Main menu .
4. Click **Upgrade** Firmware then select **USB** and choose the path.
5. Click **Transfer**. A progress bar will appear with the percentage complete.
6. Click **Apply**. A progress bar will appear with the percentage complete. The system will reboot and restart automatically when the upgrade is complete.



Upgrade Firmware - USB Drive

Uploading Setpoint Files to Supervisory Controller

1. Copy the set point file to a USB thumb drive.
2. Plug the USB thumb drive into the Supervisory Controller.
3. Login and select **Configure System > File Management & Licensing** from the Main menu .
4. Select **Restore** then select the **USB**.
5. Click the radial button for the setpoint file.

6. Select **Restore**.

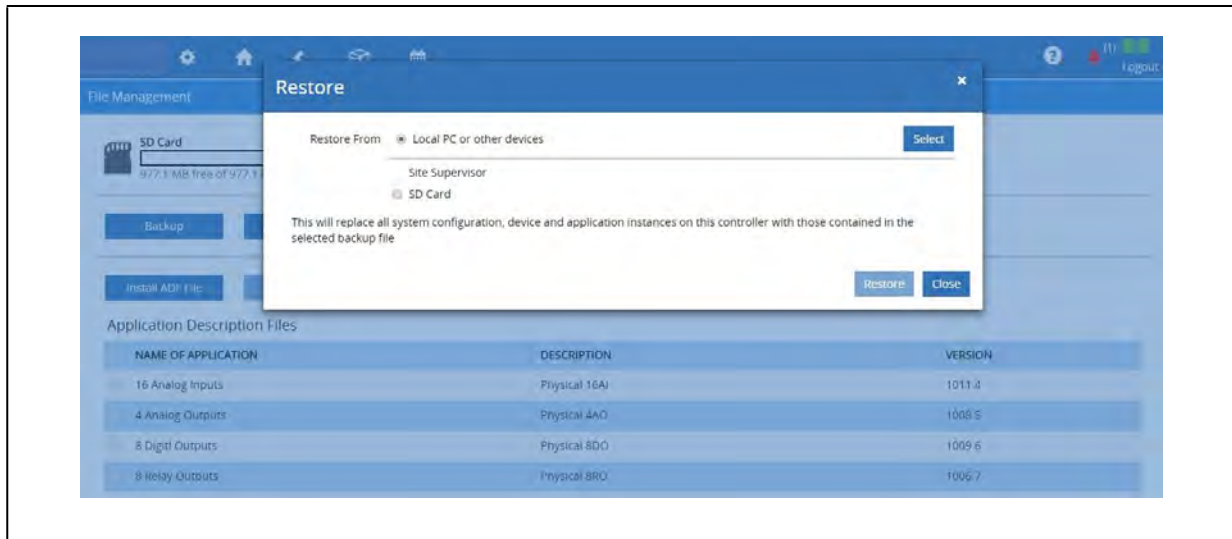

Upload Setpoint File to the Supervisory Controller

Firmware Update - Repository

Users can now upgrade forward from our resource repository. Select **Repository**, then click on the **Select** button.

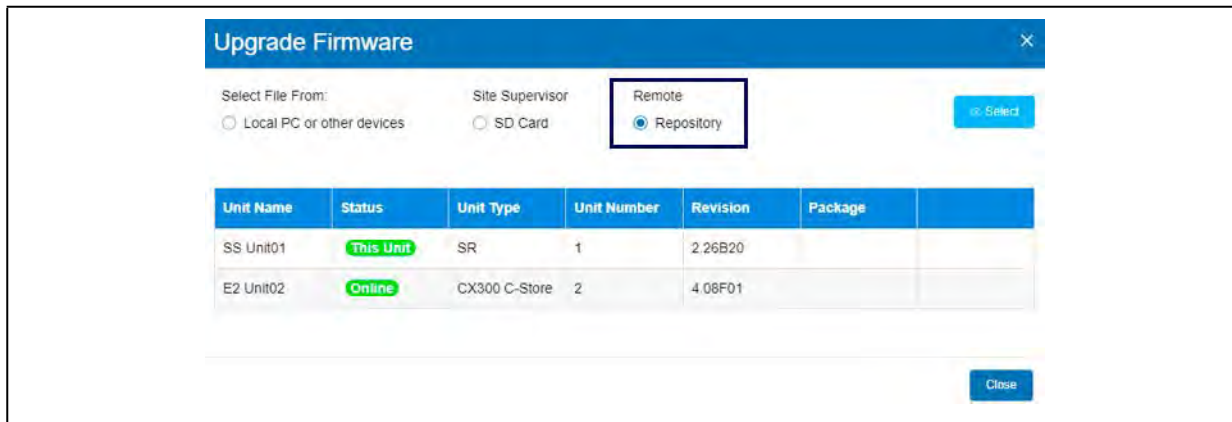

A list of available firmware versions will be displayed for the user to choose from. Version with /Latest/ path indicates the latest firmware.

Note: Use of this function requires Internet access.

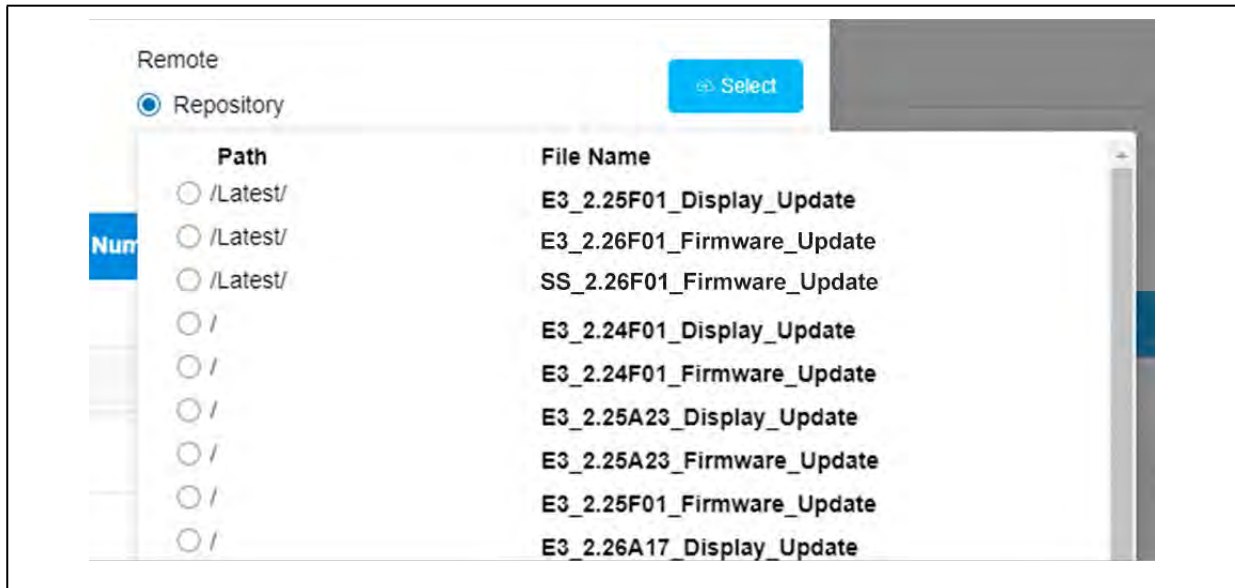

Appendix H: Reset and Clean Out Supervisory Controllers

Cleaning out a Supervisory controller should only be done if:

- If you are programming your controller for the first time.
- If all of the settings need to be cleared.
- If the program settings are unknown.

For best practices, before proceeding with a clean out, create a backup copy of system configurations, logs, and applications.

E3 Reset and Clean Out on the Main Circuit Board

Open the E3 controller panel to access the circuit board on the back of the front panel door.

There are two buttons located at the bottom left on the main board labeled **RESET** and **CLEANOUT**.

- **RESET** - The button labeled RESET on the main board resets the controller. Pressing and holding this button for one second will cause the E3 to reset and retain all programmed applications, logs, and other data stored in memory.
- **CLEANOUT** - The button labeled CLEANOUT on the main board is used to perform a function called clean out. Using this button in conjunction with the RESET button will cause a cleanout, which is a reset that erases all data from memory. The E3 will reboot after a cleanout with all programmed applications, logs, and other data erased.

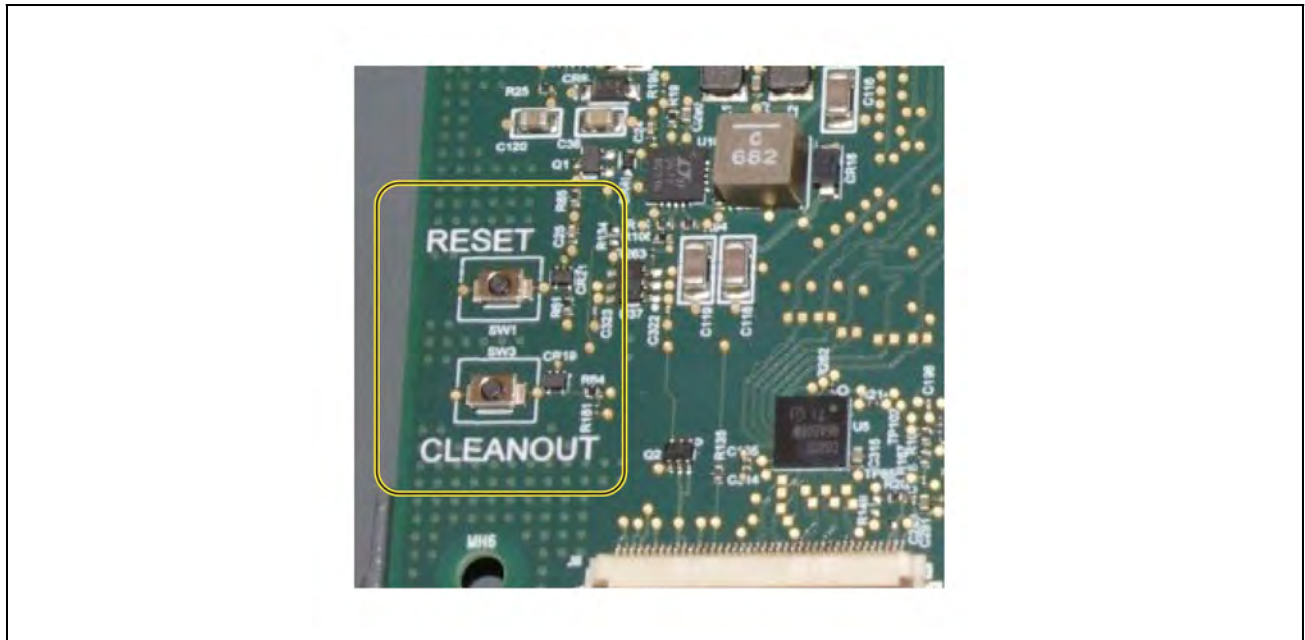

E3 Main Circuit Board Reset and Cleanout Button

 **CAUTION: A clean out will erase all programmed parameters from memory. Do not follow these instructions unless you are absolutely sure you wish to remove all applications and logs from memory. Best practices is to Backup prior to a clean out.**

Performing a Reset - Rebooting the Controller

1. Press and hold the **RESET** button for one second. The E3 will reset with all programmed data retained.

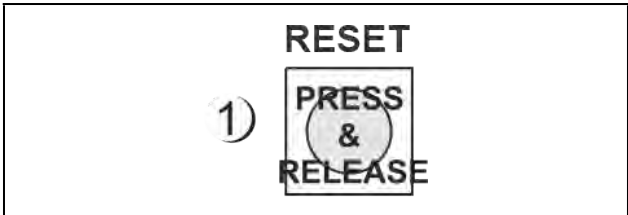

Rebooting the Controller

Site Supervisor Reset and Clean Out on the Enclosure

1. Locate the **Reset** and **Cleanout** buttons at the upper left of the Site Supervisor enclosure.
2. Use a small screwdriver or other instrument to access the **Reset** and **Cleanout** buttons by inserting into the access holes.



Site Supervisor Reset and Cleanout

Performing a Reset

1. Use a small screwdriver or other instrument to access the Reset button located in the opening on the enclosure.
2. Press and release the Reset button.
3. The LEDs will flash green and the controller will reboot.

Performing a Clean Out



CAUTION: A clean out will erase all programmed parameters from memory. Do not follow these instructions unless you are absolutely sure you wish to remove all applications and logs from memory. Best practices is to Backup prior to a clean out.

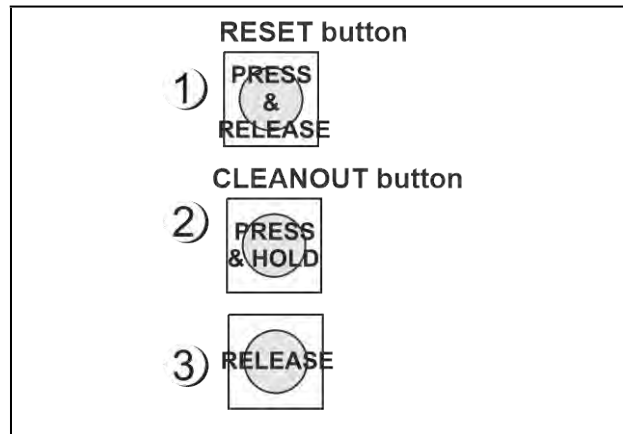

Performing a Cleanout

1. Press and release the **Reset** button quickly. The screen will clear.
2. Press and hold the **Cleanout** button.
After approximately 30 seconds, the LEDs on the front of the E3 will start alternating between orange and green.
3. Release the **Cleanout** button.

Clean Out from the UI for E3 and Site Supervisor



CAUTION: A clean out will erase all programmed parameters from memory. Do not follow these instructions unless you are absolutely sure you wish to remove all applications and logs from memory. Best practices is to Backup prior to a clean out.

1. Login and click the gear icon > **System Logs & Statistics** > **Service Log** screen.

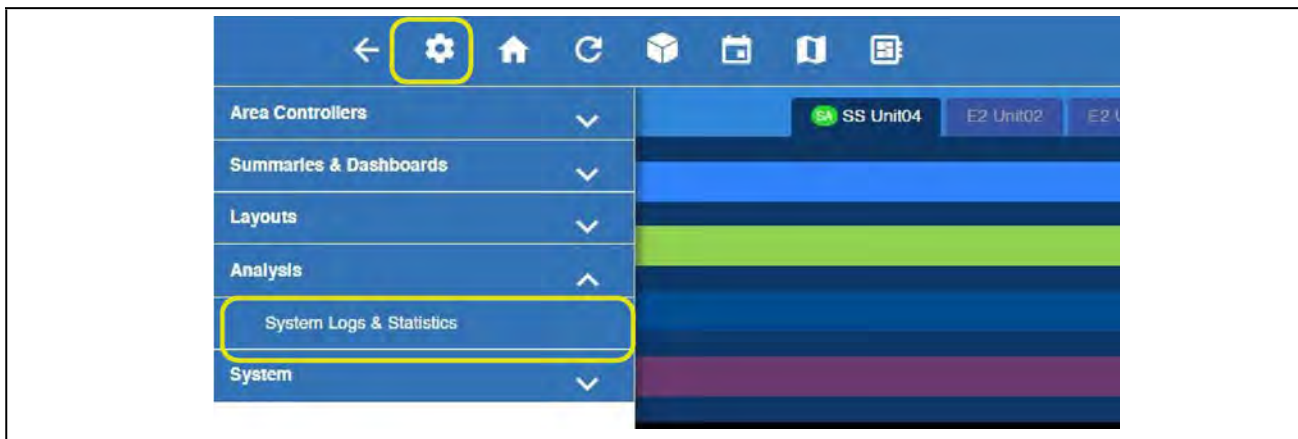

Cleanout from the UI

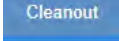
2. Click the **Cleanout** button. 
3. A login prompt will appear. Enter your username and password to proceed.
4. A warning message will appear and ask if you are sure. Select **Yes** or **Cancel**.
5. Click **Cleanout** to proceed.

Reset from the UI for E3 and Site Supervisor

Login and click the gear icon > **System Logs & Statistics** > **Service Log** screen.

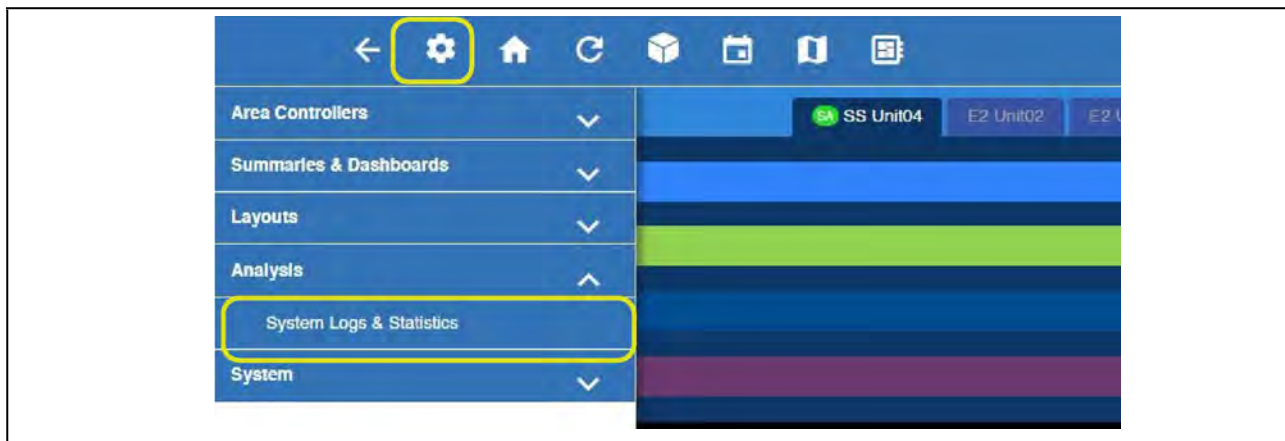

Reset from the UI

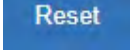
1. Click the **Reset** button. 
2. A warning message will appear and ask if you are sure. Select **OK** or **Cancel**.

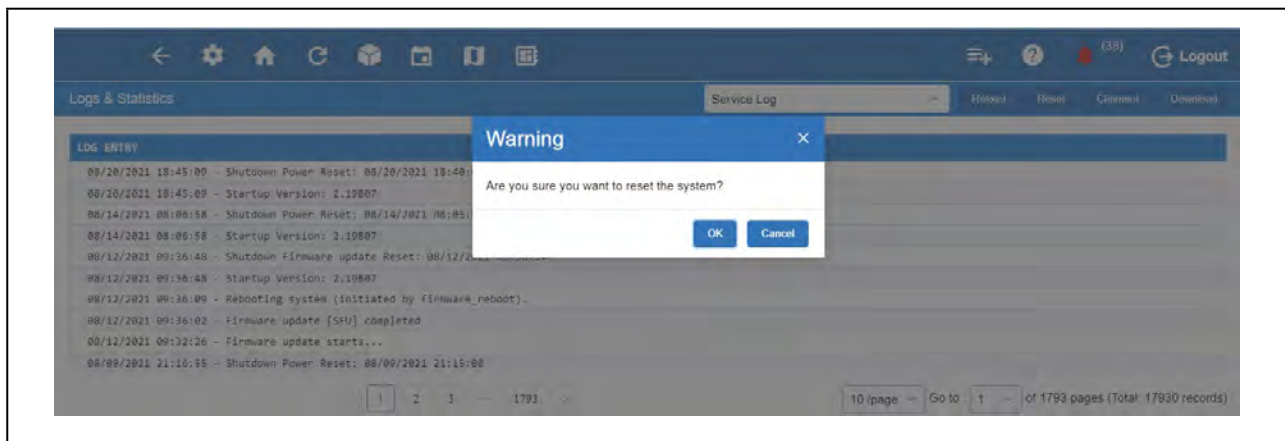

Reset System Warning Message

3. Click **OK** to proceed.
4. The controller will reboot.

Appendix I: Supervisor Scheduling and Events Training

Adding New Schedule

The Time Schedule application schedules lighting or occupancy state activities.

Time Schedule Types:

- Master (Parent)
- Slave (Child)

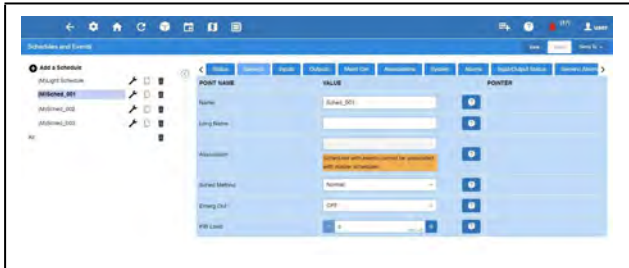

Setting Up Schedules

1. Click the **Schedules and Events** icon.
2. Click **Add a Schedule**.

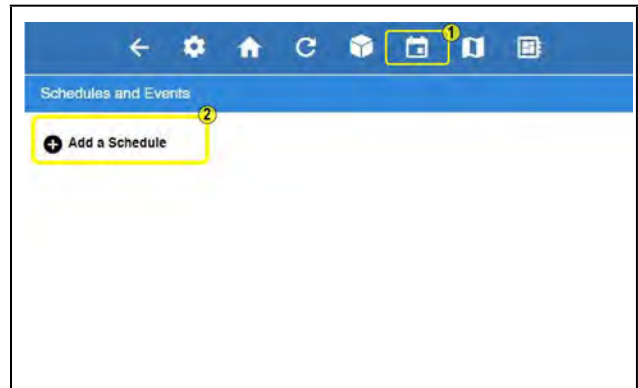

Logging In

1. Launch a preferred web browser.
2. Enter the IP address of the device.
3. The default IP Address is **192.168.0.250**.
4. Enter **user** for **Username** and **pass** for **Password** and click the **Login** button.

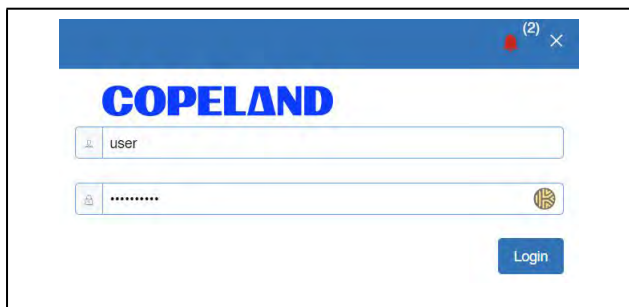

Schedules - General Tab

1. Enter a name for the new schedule.
2. Select **Others** from the Category drop-down list to specify the subsystems that the Time Schedule is providing service to.
3. If a Master (Parent) schedule has already been defined and the new schedule is to be a Slave (Child), select the Master (Parent) schedule from the Association drop-down list.



Schedules - Inputs Tab

1. Setup your inputs.

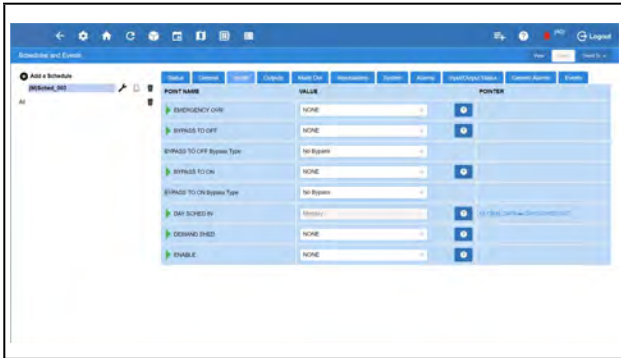

Adding Events

1. To start adding events, click the **Events** tab.

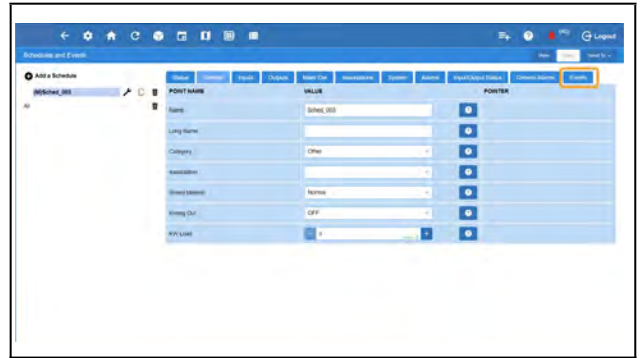

2. Click the **Add an Event** text.

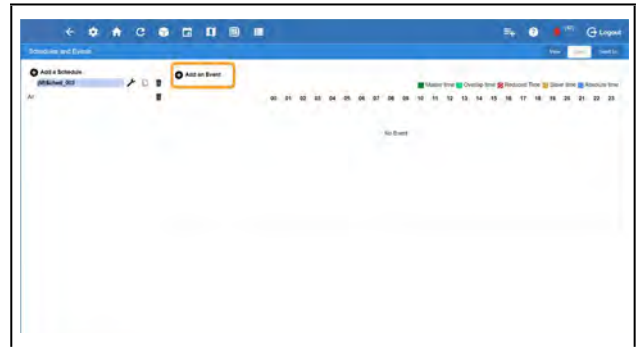

Schedules - Outputs Tab

1. Associate the output to a application/device point. To add other additional association, click the + button.
2. To override any output command, toggle the ON/OFF button and change the override parameters.
3. Click the **Submit** button to override the command.
4. Once completed, click **Save**.

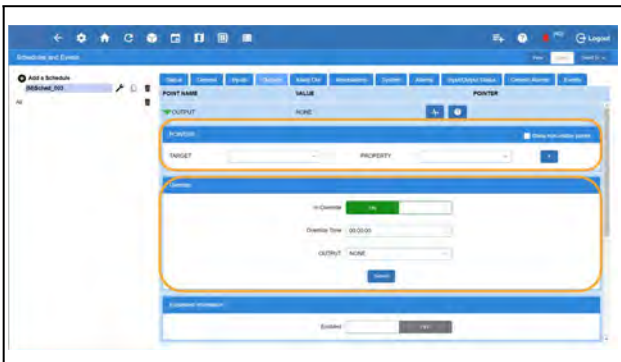

3. Enter the name for the event in the **Name** field.
4. Select the day(s) of the week that the event will occur.

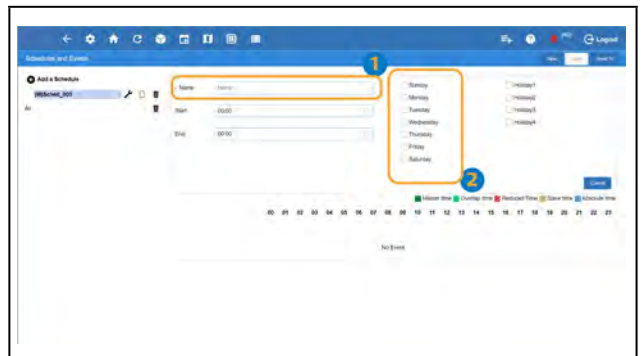

5. Use the up and down buttons to set and increase and decrease the **Start and End Time** values.
6. If this is a Slave (Child) event the times selected are relative offsets to the Master (parent) schedule and the available time ranges are from -11:55 to +11:55 (HH:MM)

7. Once completed, click **Save**.

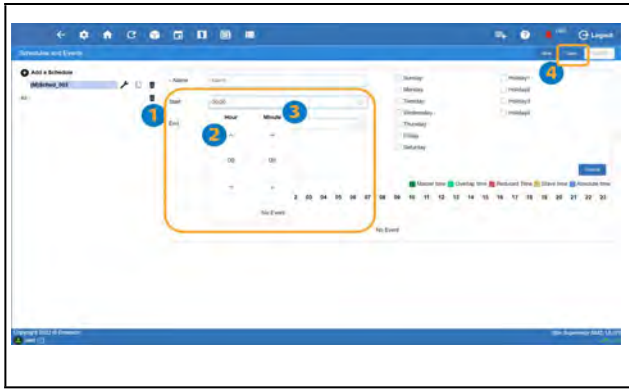

8. Upon finishing the schedule setup, the newly created event will display as shown.

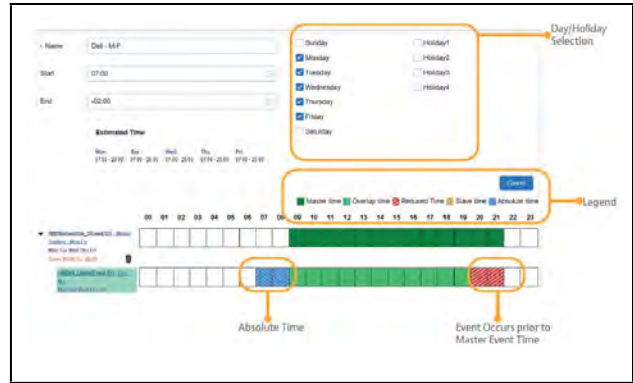
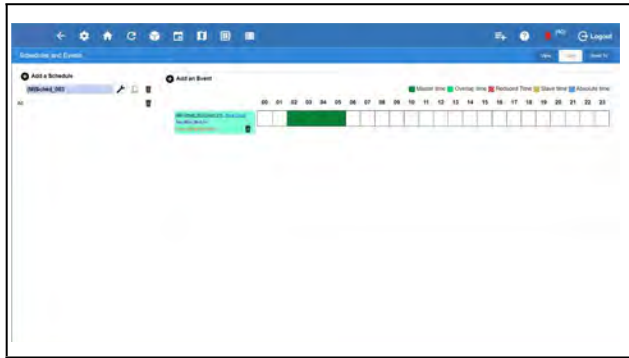

Legend:

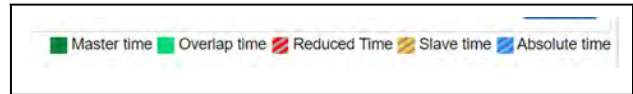

- **Master time** - Schedule for the master event
- **Overlap time** - Time of the slave event that is shared with the master schedule
- **Reduced time** - Shown with the slave event is scheduled to end before the master schedule event (may be based on relative or absolute time)
- **Slave time** - Event starts prior to master event and/or ends after master event schedule (based on relative time only)
- **Absolute time** - Time shown in blue occurs before or after the master event start and end times (based on absolute time only)

Absolute Time and Slave Events

- Addition of Absolute Time options
- Day Selection for Slave Events



Index

- A-**
- ACC 9-48
- AHU 9-52
- Alarm Information 6-1, 10-1
- Analog Combiner 9-52
- Analog Sensor Control 9-14
- Anti-Sweat 9-53
 - case-controlled
 - how setpoints work 9-53
- Application List 9-1
- Application Locations 4-7
- Applications 4-7
- B-**
- BACnet VAV 9-47
- Boards
 - 4AO Analog Output 7-9
 - 8DO Digital Output 7-9
 - 8RO Relay Output
 - defined 7-8
 - features 7-8
 - 8RO/8ROSMT 7-8
- Buttons
 - cold reset 2-1, 2-2
 - reset 2-1
- C-**
- Can 3-8
- Can Bus 3-8
- Case Clean Out 9-66
- Case Control Circuits 9-56
 - defrost in 9-58
 - overview 9-56
- Case Controllers
 - CC-100H
 - defined 9-56
 - CC-100LS
 - defined 9-56
 - CC-100P
 - defined 9-56
 - CS-100
 - defined 9-56
 - defrost 9-58
 - pump down delay 9-58
 - defrost types 9-58
 - EEPRs
 - recovery mode 9-58
 - recovery mode
 - EEPRs 9-58
 - EEVs 9-57
 - superheat control 9-57
 - temperature control 9-57
 - valves 9-56
 - EEPRs 9-57
 - EEVs 9-57
 - liquid pulse 9-57
 - liquid stepper 9-57
 - pulse 9-56
 - stepper 9-57
 - suction stepper 9-57
- CC-100H. *See Case Controllers.*
- CC-100LS. *See Case Controllers.*
- CC-100P. *See Case Controllers.*
- Clean Out 2-1
- Clean out 4-1
- Cold Reset
 - performing a 2-2
- Cold Reset Button 2-1, 2-2
- COM Port Bandwidth Calculator 4-3
- COM Ports
 - Bandwidth Calculator 4-3
- Com Ports 3-8
- Combiners 9-52
- Compatibility Matrix 8-8
- Condensers
 - input types 9-55
- Control Inventory 4-8
- Control Link ACC 9-48
- Copeland
 - Discus 7-13
 - ISD 7-13
 - Scroll 7-13
- Copeland Digital Discus Compressor 9-11, 9-13
- CS-100 9-56
- CS-100. *See Case Controllers, CS-100*
- D-**
- Data Logging 9-46
- Defrost
 - defrost cycle 9-58
 - demand 9-59
 - fail-safe time 9-59
 - drip time. *See Defrost, run-off time.*
 - electric 9-58
 - emergency 9-59
 - hot gas 9-58
 - in case controlled circuits 9-58
 - inhibiting, using demand sensors 9-59
 - off-cycle 9-58
 - pulsed 9-59
 - pump down delay 9-58
 - reverse cycle hot gas 9-58
 - run-off time 9-58
 - termination 9-58
 - pulsed defrost 9-59
 - temperature 9-58
 - timed (off-cycle) 9-58

Demand Control 9-30
 Demand Defrost. *See Defrost, demand.*
 Digital Combiner 9-52
 Digital Discus Compressor 9-11, 9-13
 Digital Scroll Compressor Support 9-13
 Digital Sensor Control 9-15
 Discus Compressor 9-11, 9-13
 Display 7-11, 7-12
-E-
 E3 2-1
 Hardware 2-1
 Part Numbers 2-1
 Reset 2-1
 Specifications 2-2
 Updating ETH1 IP Address 12-7
 ECB VAV 9-47
 Electric Defrost. *See Defrost, electric.*
 Energy Meter 9-46
 Enhanced Suction Group 9-12
 ETH1 IP Address
 Updating 12-7
-F-
 Flexible Combiner 9-46
-G-
 gging 5-1
 Global Data 9-20
-H-
 Hand-held Terminal 7-7
 Hand-held Terminal (HHT) 7-7
 Help Menu 4-11
 Hot Gas Defrost. *See Defrost, hot gas.*
 HVAC Control 9-20
 HVAC Zone 9-48
-I-
 I/O Boards 7-1
 I/O Network 7-1
 problems with 12-2
 Icons 4-12
 Inputs
 Analog 3-10
 Digital 3-9
 IP Address Location 12-4
 IPX 9-67
 Irrigation Control 9-59
-L-
 Languages 4-6
 Lighting Control 9-17
 Logging 9-46
 Logging Group 5-1
 Logging Group, Data Types 5-1
 Logging Groups, Supported Function 5-1
 Loop Sequence Control 9-61
-M-
 Matrix 9-1
 Memory
 clearing all data from 2-1
 Menus 4-1, 5-2
 Modular Chiller Control 9-62
 Mounting 3-3
 MultiFlex 16 Board
 features 7-1
 MultiFlex Boards 7-1
 16 7-1
 combination input/output 7-2
 RCB 7-6
 RTU 7-6
 MultiFlex ESR Board 7-7
 MultiFlex RCB 7-6
 MultiFlex RTU 7-6
 MultiFlex RTU Satellite Inputs 7-3
-N-
 Navigation 4-1
-O-
 Off-Cycle Defrost. *See Defrost, off-cycle.*
 OnBoard I/O 9-33
 Online Help Menu 4-11
-P-
 Peer to Peer Network 15-23
 Peer to Peer Network Setup 6-7
 Performance Meter 4-7
 PID Control 16-1
 PMAC II
 defined 7-9
 Programmable Touchscren Thermostat 7-12
 Pulse Modulating Anti-Sweat Controller. *See PMAC II.*
 Pulsed Defrost. *See Defrost, pulsed.*
 Push Button Override 9-17
-R-
 RCB 7-6
 Recovery Mode, for Case Controllers 9-57
 Relay Outputs 3-9
 Reset 4-1
 Reset Button 2-1
 Reverse Cycle Hot Gas. *See Defrost, reverse cycle hot gas.*
 Revision History 2-1
 RLDS 9-47
 RS485 Network 7-1
 RTU 7-6
-S-
 SD Card 3-6
 Serial Connections 3-8
 Site Manager Compatibility 9-68, 9-69
 Site Supervisor
 Hardware 3-1
 Part Numbers 3-1
 Specifications 3-2
 Site Supervisor Display 7-11, 8-1
 Connections, 10.1 Inch 8-1

- Connections, 15.6 Inch 8-4
- Connections, 21.5 Inch 8-6
- Specifications, 10.1 Inch 8-2
- Specifications, 15.6 Inch 8-4
- Specifications, 21.5 Inch 8-6
- Touchscreen, 10.1 Inch 8-1
- Smart Alarming 6-6
- Software Applications 9-11
- Standard Circuits 9-55
- Suction Float 9-14
- Suction Group 9-1
- Suction Groups 9-11
 - Enhanced 9-11
 - floating setpoint control 9-12
 - Introduction 9-11
 - PID control strategy overview 9-12
 - variable-speed compressors 9-12
- Superheat Control 9-57
- Supervisory Controller 1-1
 - Clean Out 2-3
 - Reset 2-2
- Supervisory Controller IP Address 1-4
- Supervisory Controller Login 1-3
- Supervisory Controller Setup 1-5
- Supervisory Controllers
 - Reset 2-1, 3-1
- Supported Browsers 1-1
- T-**
- TD Control 9-60
- Temperature Control
 - case controllers 9-57
- Temperature Differential (TD) Control
 - alarms 9-61
 - configuration 9-60
 - inputs 9-61
 - setpoints 9-61
 - TD failsafes 9-60
 - TD strategy 9-60
- Termination Jumpers 3-5
- Thermostatic Expansion Valves. See TXVs.
- Time Schedule 9-25
- Touch T-Stat 9-45
- Touchscreen Display
 - 10.1 Inch 8-1
 - 15.6 Inch 8-3
 - 21.5 Inch 8-6
- Troubleshooting 12-1, 13-1, 14-1
- T-Stat 9-45
- TXVs
 - control using CC-100s 9-57
- U-**
- UL Ratings 3-10
- User Interface 4-1
- Utility Monitoring 9-31

- V-**
- Variable Air Volume (VAV) 9-47
- VAV (Variable Air Volume) 9-47
- W-**
- Wireless 7-10
- Wiring
 - Site Supervisor 3-5
 - Supervisory Controller and MultiFlex 3-11
 - Supervisory Controller and XR35CX 3-12
- X-**
- XC645CX 9-39
- XJ Condensing Unit 9-67
- XM Circuit
 - advisories 9-66
 - associations 9-64
 - case circuit support 9-64
 - commands 9-66
 - data synchronization
 - parameters 9-64
 - visibility 9-64
 - suction group interaction 9-64
 - supervisory control functions 9-65
 - active setpoint output 9-65
 - case states 9-65
 - case type 9-66
 - defrost scheduling 9-65
 - dewpoint 9-65
 - lighting 9-65
- XM Circuit Control 9-63
- XM Controllers 7-9
- XM Series of Controllers 7-9
 - XM670 7-9
 - XM678 7-10
 - XM679 7-10
- XR35CX 9-36
- XR75CX 9-43
- XR75CX Case Display 9-42

Revision History

What's new in the Supervisory Controller User Guide:

- Added Security information
- ADF Part Number visibility on File Management and Licensing
- "General System Properties" updated to "General System Settings" on Supervisor screen
- "Configure Settings" updated to "System" on Supervisor screen
- "System Summary" updated to "System Tile" on Supervisor screen

Or scan the QR code for more product information and the latest release notes:



For Technical Support call 833-409-7505 or email ColdChain.TechnicalServices@Copeland.com

The contents of this publication are presented for informational purposes only and they are not to be construed as warranties or guarantees, express or implied, regarding the products or services described herein or their use or applicability. Copeland reserves the right to modify the designs or specifications of such products at any time without notice. Responsibility for proper selection, use and maintenance of any product remains solely with the purchaser and end-user. ©2024 Copeland is a trademark of Copeland LP.